



TEL: 800.BRADLEY
FAX: 262.251.5817
bradleycorp.com

Mills Phenolic Partitions Service Parts List Price Book 0418MSP

Effective Date April 1, 2018

Table of Contents

Layouts with Reference Numbers

Series 400 (Floor-Mount with Overhead Brace) and 500 (Floor-Braced)	2
Series 600 (Ceiling-Hung) and 700 (Floor-to-Ceiling)	3

Headrail Part Numbers and Kits

① Headrail	4
② Headrail Open-End Kit	4
③ Headrail Between-the-Wall Kit	4

Shoes and Sleeves

④ Shoe/Sleeve Kits	5-6
--------------------	-----

Inswing and Outswing Door Kits

⑤ Inswing Door Kits	7-11
⑥ Outswing Door Kits	12-16

Pilaster and Panel Kits

⑦ Pilaster at Wall "F" Kits	17
Pilaster at Panel "F" Kits	17
Pilaster at Pilaster "F" Kits	17
⑧ Dividing/Ending Panel Kits	18

Additional Kits

Alcove Kit	19
Urinal Screen Bracket Kit	20
Posts, No-Site Strips	21
Hinge and Latch Kits	22
Coat Hooks, Door Pulls and Wall Bumpers	23
Strike/Keeper Kits	24
Continuous Stainless Steel Piano Hinge	24
Pilaster Channel/Panel Channel Kits	24-25

Series 400 and Series 500 Layouts

Series 400
Floor-Mounted with Overhead Brace

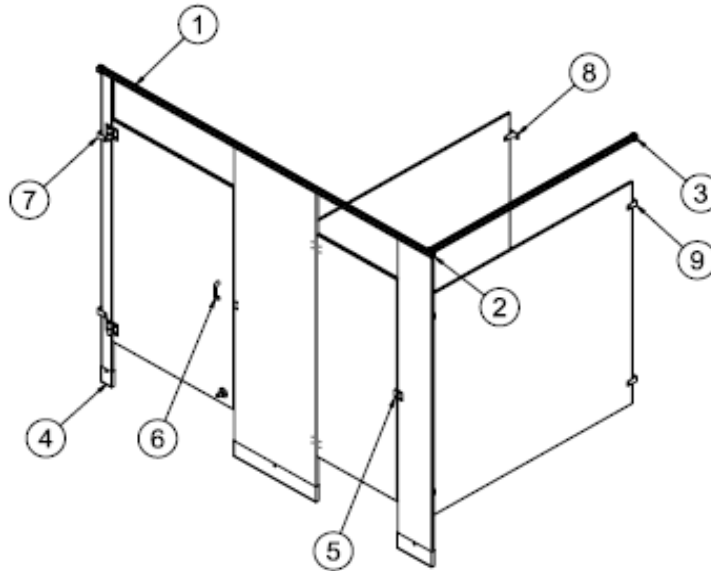

Series 500
Floor-Braced

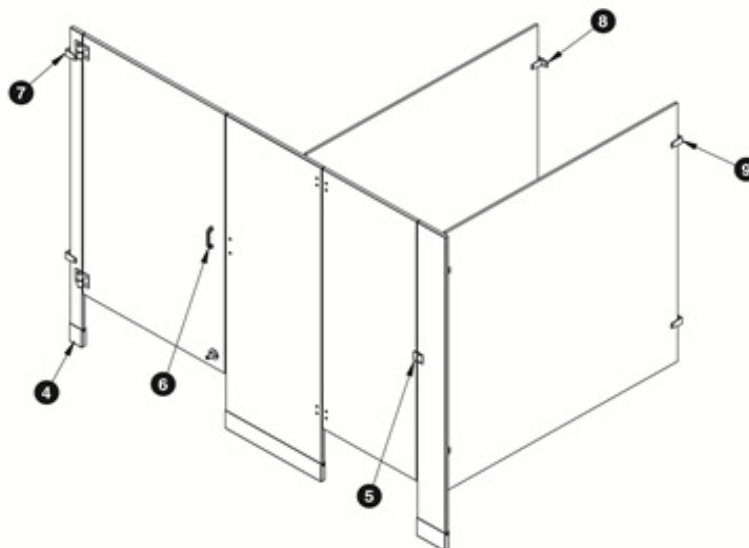

Series 600 and Series 700 Layouts

Series 600
Ceiling-Hung

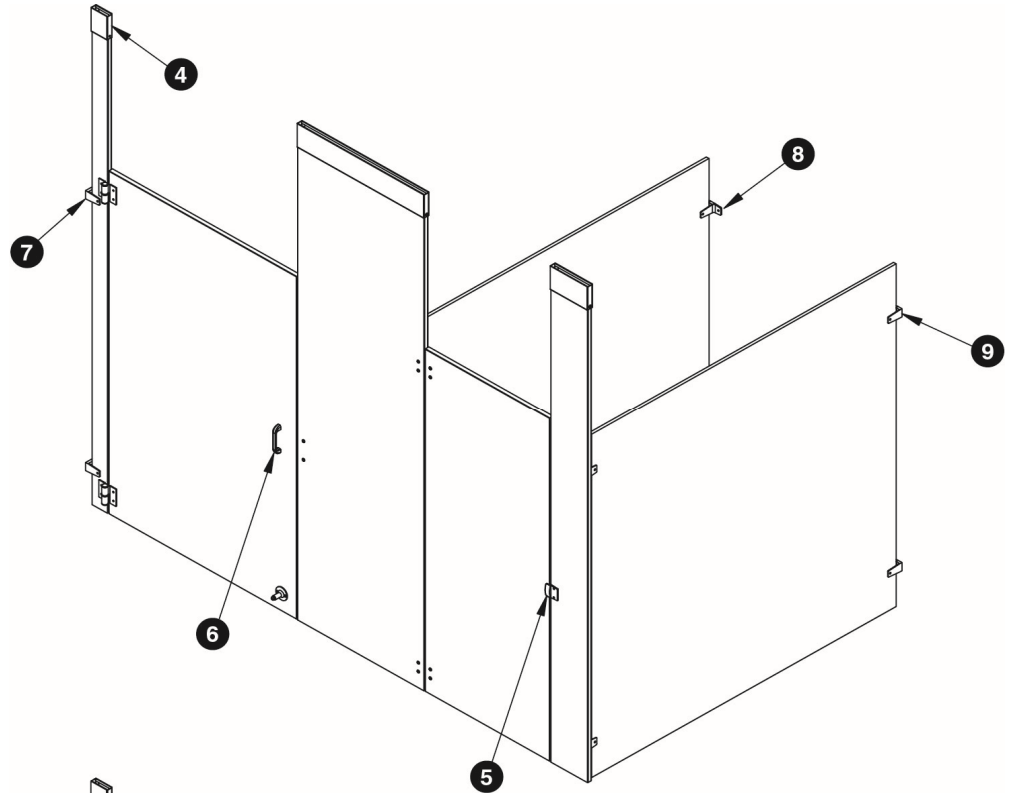

Series 700
Floor-to-Ceiling

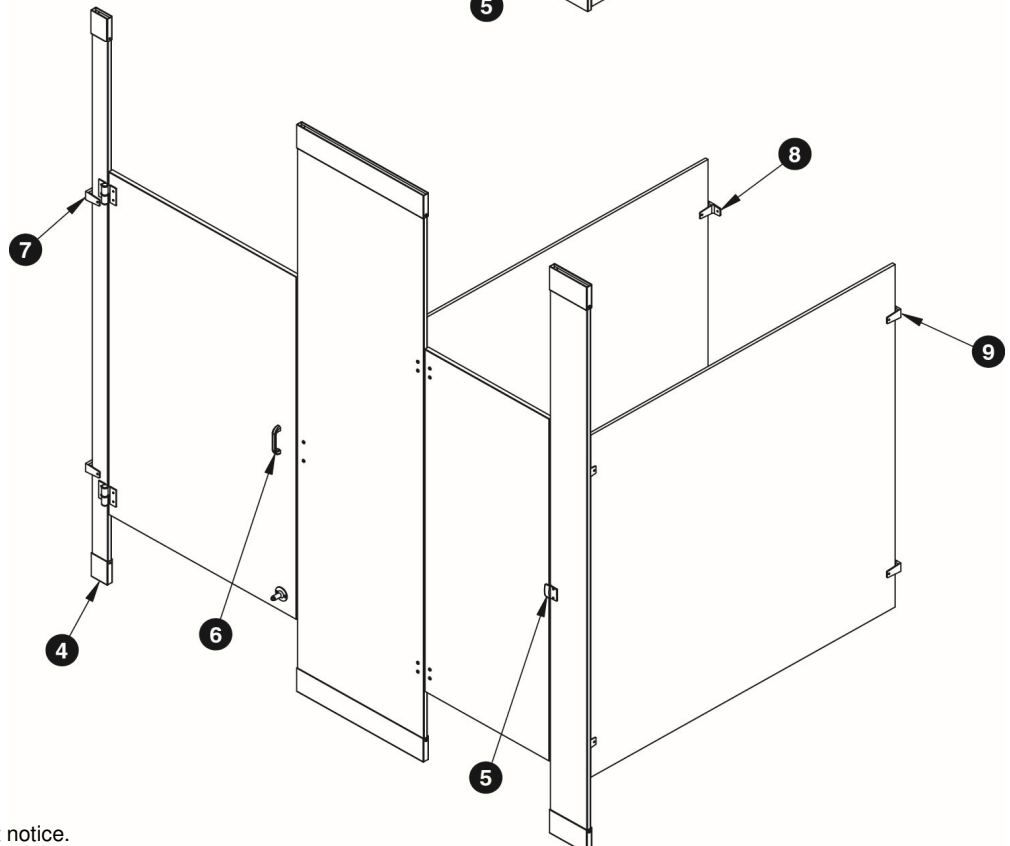

Prices subject to change without notice.
Items may be changed or discontinued
without notice and without incurring obligation.

Effective Date April 1, 2018

Headrail and Headrail Kits

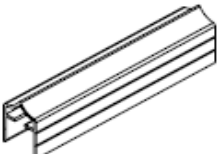
① Headrail only (mounting kits sold separately)	Part No.	Description	Qty.	List Price
	HDWC-A0458-037	Actual Size 37"	1	\$ 18.00
	HDWC-A0458-059	Actual Size 59"	1	\$ 26.00
	HDWC-A0458-062	Actual Size 62"	1	\$ 29.00
	HDWC-A0458-073	Actual Size 73"	1	\$ 36.00
	HDWC-A0458-084	Actual Size 84"	1	\$ 41.00
	HDWC-A0458-120	Actual Size 120"	1	\$ 61.00

② Headrail Open End Kit	HDWC-A0461-OE	List Price	
	Includes:		
			\$ 21.00
	Part No.	Description	Qty.
	a	HDWC-P0459 Headrail Bracket 3/4"	3
	b	HDWC-P0460 Headrail End Cap 3/4"	1
	c	FAST-T373 Plastic Anchor #14-16 x 3/8"	4
d	FAST-P002 Screw #14 x 2" BTN	4	
e	FAST-S0019 Screw #10 x 5/8" BTN	14	

NOTE: Torx bits are not included but can be ordered separately.

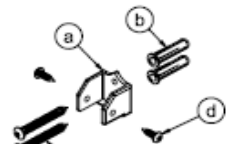
③ Headrail Between-the-Wall Kit	HDWC-A0461-BW	List Price	
	Includes:		
			\$ 13.00
	Part No.	Description	Qty.
	a	HDWC-P0459 Headrail Bracket 3/4"	2
	b	FAST-T373 Plastic Anchor #14-16 x 3/8"	4
	c	FAST-P002 Screw #14 x 2" BTN	4
d	FAST-S0019 Screw #10 x 5/8" BTN	12	

NOTE: Torx bits are not included but can be ordered separately.

Effective Date April 1, 2018

Shoe Kits

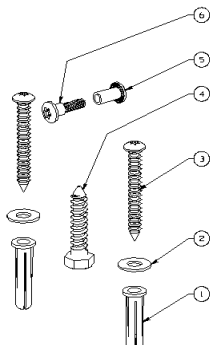
④ Pilaster FMOB Shoe Kit (Stainless Steel)	Part No.	Description	Qty.	List Price
	HDWC-S0451-03	Actual Size 3"	1	\$ 38.00
	HDWC-S0451-04	Actual Size 4"	1	\$ 39.00
	HDWC-S0451-05	Actual Size 5"	1	\$ 40.00
	HDWC-S0451-06	Actual Size 6"	1	\$ 40.00
	HDWC-S0451-07	Actual Size 7"	1	\$ 41.00
	HDWC-S0451-08	Actual Size 8"	1	\$ 41.00
	HDWC-S0451-10	Actual Size 10"	1	\$ 42.00
	HDWC-S0451-12	Actual Size 12"	1	\$ 43.00
	HDWC-S0451-14	Actual Size 14"	1	\$ 44.00
	HDWC-S0451-16	Actual Size 16"	1	\$ 51.00
	HDWC-S0451-18	Actual Size 18"	1	\$ 51.00
	HDWC-S0451-22	Actual Size 22"	1	\$ 57.00
HDWC-S0451-24	Actual Size 24"	1	\$ 57.00	

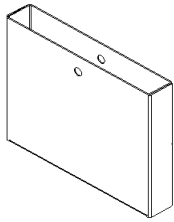

Includes Hardware:			
	Part No.	Description	Qty.
	HDWC-S0443-XX	Pilaster Shoe (XX equals the shoe size)	
1	FAST-T373	Plastic Anchor #14-16 x 3/8"	2
2	P10-449	Washer .281x .625x .045 Flat 18-8 SS	2
3	FAST-P002	Screw 14 x 2 BTN SM Torx-T27 w/Pin 18-8 SS	2
4	FAST-S008	Screw 5/16 x 1-1/2 Hex Lag SS	1
5	FAST-S0017	Screw 10-24 x 1/2" BTN Step-Female Torx-T27 w/Pin 18-8 SS	1
6	FAST-P004	Screw 10-24 x 3/4" BTN Step-Male Torx-T27 w/Pin 18-8 SS	1

NOTE: Torx bits are not included but can be ordered separately.

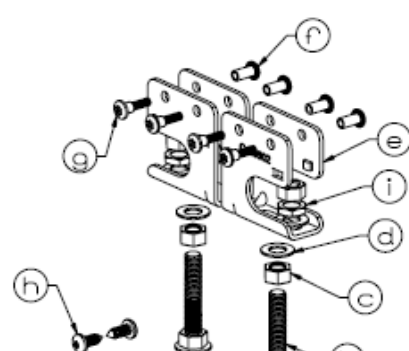
④ Pilaster FB Shoe Kit (Stainless Steel)	Part No.	Description	Qty.	List Price
	HDWC-S0452-03	Actual Size 3"	1	\$ 49.00
	HDWC-S0452-04	Actual Size 4"	1	\$ 50.00
	HDWC-S0452-05	Actual Size 5"	1	\$ 51.00
	HDWC-S0452-06	Actual Size 6"	1	\$ 51.00
	HDWC-S0452-07	Actual Size 7"	1	\$ 52.00
	HDWC-S0452-08	Actual Size 8"	1	\$ 52.00
	HDWC-S0452-10	Actual Size 10"	1	\$ 53.00
	HDWC-S0452-12	Actual Size 12"	1	\$ 54.00
	HDWC-S0452-14	Actual Size 14"	1	\$ 55.00
	HDWC-S0452-16	Actual Size 16"	1	\$ 60.00
	HDWC-S0452-18	Actual Size 18"	1	\$ 60.00
	HDWC-S0452-22	Actual Size 22"	1	\$ 66.00
HDWC-S0452-24	Actual Size 24"	1	\$ 66.00	

Includes Hardware:			
	Part No.	Description	Qty.
a	HDWC-S0446-XX	Pilaster Shoe (XX equals the shoe size)	1
b	FAST-S0040	Wedge Anchor 3/8"-16 x 3-3/4" SS	2
c	FAST-S0041	Nut 3/8"-16 Hex SS	4
d	FAST-S0042	Washer .406x.750x.063 Flat SS	4
e	HDWC-S0502	Leveling Bracket FB/CH	2
f	FAST-S0017	Screw 10-24 x 1/2" BTN Step Barrel-Female Torx w/Pin 18-8 SS	4
g	FAST-P004	Screw 10-24 x 3/4" BTN Step-Male Torx-T27 w/Pin 18-8 SS	4
h	FAST-S355A	Screw 1/4-14 x 5/8" BTN T/S Torx-T27 w/Pin 410SS NKLP	2
i	FAST-S0044	Spacer Nut 18-8 SS	2

NOTE: Torx bits are not included but can be ordered separately.

Effective Date April 1, 2018

Shoe Kits

4 Pilaster CH Shoe Kit (Stainless Steel)	Part No.	Description	Qty.	List Price
	HDWC-S0453-03	Actual Size 3"	1	\$ 39.00
	HDWC-S0453-04	Actual Size 4"	1	\$ 39.00
	HDWC-S0453-05	Actual Size 5"	1	\$ 40.00
	HDWC-S0453-06	Actual Size 6"	1	\$ 40.00
	HDWC-S0453-07	Actual Size 7"	1	\$ 41.00
	HDWC-S0453-08	Actual Size 8"	1	\$ 41.00
	HDWC-S0453-10	Actual Size 10"	1	\$ 42.00
	HDWC-S0453-12	Actual Size 12"	1	\$ 44.00
	HDWC-S0453-14	Actual Size 14"	1	\$ 49.00
	HDWC-S0453-16	Actual Size 16"	1	\$ 53.00
	HDWC-S0453-18	Actual Size 18"	1	\$ 53.00
	HDWC-S0453-22	Actual Size 22"	1	\$ 60.00
	HDWC-S0453-24	Actual Size 24"	1	\$ 60.00

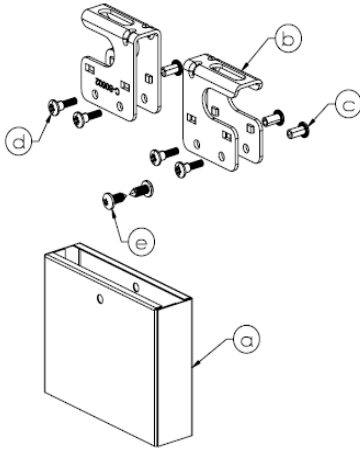

Includes Hardware:			
Part No.	Description	Qty.	
a	HDWC-S0446-XX	Pilaster Shoe (XX equals the shoe size)	1
b	HDWC-S0502	Leveling Bracket FB/CH	2
c	FAST-S0017	Screw 10-24 x 1/2" BTN Step Barrel-Female Torx w/Pin 18-8 SS	2
d	FAST-P004	Screw 10-24 x 3/4" BTN Step-Male Torx-T27 w/Pin 18-8 SS	2
e	FAST-S355A	Screw 1/4-14 x 5/8" BTN T/S Torx-T27 w/Pin 410SS NKLP	2

4 Ceiling Stud (for Series 600)	Part No.	Description	Qty.	List Price
	HDWT-Z0455-2			\$ 14.00
a	FAST-S0042	Washer .406 x .750 x .050 Flat 18-8 SS	6	
b	FAST-T5416	Threaded Rod 3/8 - 16 x 6 UNC-2A	2	
c	FAST-T680	Washer 1-1/4 SQ x 3/8 Bevel 3/8 Screw Cast Iron	2	
d	FAST-T377	Washer 3/4" Split-Lock Zamac P S	2	
e	FAST-T375	Nut 3/8 - 16 Hex Zamac P S	8	
f	FAST-S0044	Spacer Nut 18-8 SS	2	

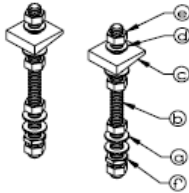

NOTE: Torx bits are not included but can be ordered separately.

4 Pilaster FTC Shoe Kit (Stainless Steel)	Part No.	Description	Qty.	List Price
	HDWC-S0454-03	Actual Size 3"	1	\$ 63.00
	HDWC-S0454-04	Actual Size 4"	1	\$ 64.00
	HDWC-S0454-05	Actual Size 5"	1	\$ 65.00
	HDWC-S0454-06	Actual Size 6"	1	\$ 66.00
	HDWC-S0454-07	Actual Size 7"	1	\$ 67.00
	HDWC-S0454-08	Actual Size 8"	1	\$ 67.00
	HDWC-S0454-10	Actual Size 10"	1	\$ 70.00
	HDWC-S0454-12	Actual Size 12"	1	\$ 74.00
	HDWC-S0454-14	Actual Size 14"	1	\$ 83.00
	HDWC-S0454-16	Actual Size 16"	1	\$ 84.00
	HDWC-S0454-18	Actual Size 18"	1	\$ 87.00
	HDWC-S0454-22	Actual Size 22"	1	\$ 87.00
	HDWC-S0454-24	Actual Size 24"	1	\$ 92.00

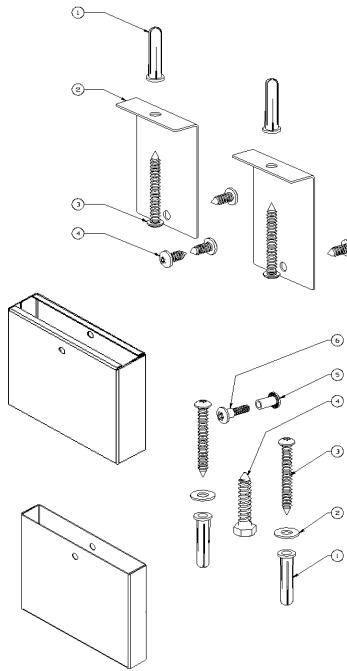

Includes Hardware:			
Part No.	Description	Qty.	
	HDWC-S0443-XX	Pilaster Shoe (XX equals the shoe size)	1
	HDWC-S0446-XX	Pilaster Sleeve (XX equals the shoe size)	1
1	FAST-T373	Plastic Anchor #14-16 x 3/8"	2
2	HDWC-T0440	Bracket "L" FTC	2
3	FAST-P002	Screw 14 x 2 BTN SM Torx-T27 w/Pin 18-8 SS	2
4	FAST-S355A	Screw 1/4-14 x 5/8" BTN T/S Torx-T27 w/Pin 410SS NKLP	4
1	FAST-T373	Plastic Anchor #14-16 x 3/8"	2
2	P10-449	Washer.281x .625x .045 Flat 18-8 SS	2
3	FAST-P002	Screw 14 x 2 BTN SM Torx-T27 w/Pin 18-8 SS	2
4	FAST-S008	Screw 5/16 x 1-1/2 Hex Lag SS	1
5	FAST-S0017	Screw 10-24 x 1/2" BTN Step Barrel-Female Torx w/Pin 18-8 SS	1
6	FAST-P004	Screw 10-24 x 3/4" BTN Step-Male Torx-T27 w/Pin 18-8 SS	1

NOTE: Torx bits are not included but can be ordered separately.

Prices subject to change without notice.
Items may be changed or discontinued
without notice and without incurring obligation.

Effective Date April 1, 2018

Inswing Door Kits

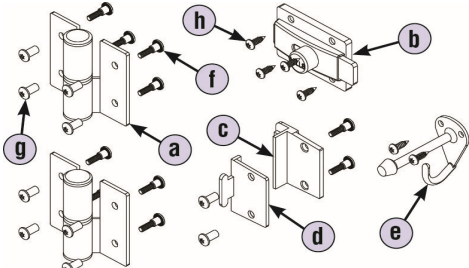
	HDWC-SD1-LH			List Price
	Includes:			\$ 91.00
	Part No.	Description	Qty.	
a	HDWC-S0211	Surface-Mounted Hinge (LHI/RHO)	1	
b	HDWL-S160	Slide Latch	1	
c	HDWC-S919	Door Stop Inswing	1	
d	HDWL-S918	Door Keeper	1	
e	HDWT-S285	Coat Hook with Bumper	1	
f	FAST-P004	Screw #10-24 x 3/4" BTN Step-Male Torx-T27	10	
g	FAST-S0017	Screw #10-24 x 1/2" BTN Barrel-Female w/Pin SS	10	
h	FAST-S0019	Screw #10 x 5/8" BTN Sheet Metal Torx-T25 w/Pin SS	6	

NOTE: Torx bits are not included but can be ordered separately.

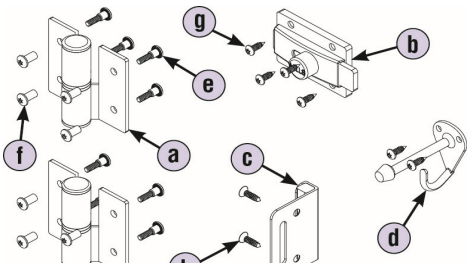
	HDWC-SD1-LHFS			List Price
	Includes:			\$ 93.00
	Part No.	Description	Qty.	
a	HDWC-S0211	Surface-Mounted Hinge (LHI/RHO)	1	
b	HDWL-S160	Slide Latch	1	
c	HDWC-S0029	Flat Door Stop/Keeper	1	
d	HDWT-S285	Coat Hook with Bumper	1	
e	FAST-P004	Screw #10-24 x 3/4" BTN Step-Male Torx-T27	8	
f	FAST-S0017	Screw #10-24 x 1/2" BTN Barrel-Female w/Pin SS	8	
g	FAST-S0019	Screw #10 x 5/8" BTN Sheet Metal Torx-T25 w/Pin SS	6	
h	FAST-S0006	Screw #10 x 3/4" FL Sheet Metal Torx-T25	2	

NOTE: Torx bits are not included but can be ordered separately.

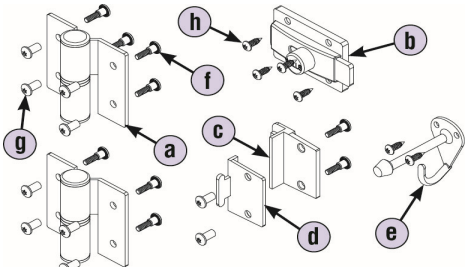
	HDWC-SD1-RH			List Price
	Includes:			\$ 91.00
	Part No.	Description	Qty.	
a	HDWC-S0212	Surface-Mounted Hinge (RHI/LHO)	1	
b	HDWL-S160	Slide Latch	1	
c	HDWC-S919	Door Stop Inswing	1	
d	HDWL-S918	Door Keeper	1	
e	HDWT-S285	Coat Hook with Bumper	1	
f	FAST-P004	Screw #10-24 x 3/4" BTN Step-Male Torx-T27	10	
g	FAST-S0017	Screw #10-24 x 1/2" BTN Barrel-Female w/Pin SS	10	
h	FAST-S0019	Screw #10 x 5/8" BTN Sheet Metal Torx-T25 w/Pin SS	6	

NOTE: Torx bits are not included but can be ordered separately.

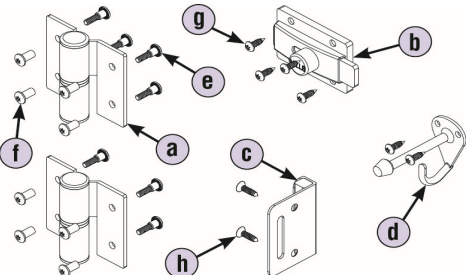
	HDWC-SD1-RHFS			List Price
	Includes:			\$ 93.00
	Part No.	Description	Qty.	
a	HDWC-S0212	Surface-Mounted Hinge (RHI/LHO)	1	
b	HDWL-S160	Slide Latch	1	
c	HDWC-S0029	Flat Door Stop/Keeper	1	
d	HDWT-S285	Coat Hook with Bumper	1	
e	FAST-P004	Screw #10-24 x 3/4" BTN Step-Male Torx-T27	8	
f	FAST-S0017	Screw #10-24 x 1/2" BTN Barrel-Female w/Pin SS	8	
g	FAST-S0019	Screw #10 x 5/8" BTN Sheet Metal Torx-T25 w/Pin SS	6	
h	FAST-S0006	Screw #10 x 3/4" FL Sheet Metal Torx-T25	2	

NOTE: Torx bits are not included but can be ordered separately.

Prices subject to change without notice.
Items may be changed or discontinued
without notice and without incurring obligation.

Effective Date April 1, 2018

Inswing Door Kits

	HDWC-SD1-LHHC	List Price																																																												
	<table border="1"> <thead> <tr> <th colspan="4">Includes:</th> </tr> <tr> <th>Part No.</th> <th>Description</th> <th>Qty.</th> <th></th> </tr> </thead> <tbody> <tr><td>a</td><td>HDWC-S0211</td><td>Surface-Mounted Hinge (LHI/RHO)</td><td>1</td></tr> <tr><td>b</td><td>HDWL-S160</td><td>Slide Latch</td><td>1</td></tr> <tr><td>c</td><td>HDWC-S919</td><td>Door Stop Inswing</td><td>1</td></tr> <tr><td>d</td><td>HDWL-S918</td><td>Door Keeper</td><td>1</td></tr> <tr><td>e</td><td>HDWT-S275</td><td>Coat Hook Outswing</td><td>1</td></tr> <tr><td>f</td><td>HDWT-S282</td><td>Door Pull</td><td>1</td></tr> <tr><td>g</td><td>HDWT-S177</td><td>Wall Bumper</td><td>1</td></tr> <tr><td>h</td><td>HDW0-S0167</td><td>Door Pull with Countersink SS</td><td>1</td></tr> <tr><td>i</td><td>FAST-S0017</td><td>Screw #10-24 x 1/2" BTN Barrel-Female w/Pin SS</td><td>10</td></tr> <tr><td>j</td><td>FAST-S0019</td><td>Screw #10 x 5/8" BTN Sheet Metal Torx-T25 w/Pin SS</td><td>6</td></tr> <tr><td>k</td><td>FAST-P004</td><td>Screw #10-24 x 3/4" BTN Step-Male Torx-T27</td><td>10</td></tr> <tr><td>l</td><td>FAST-S0016</td><td>Screw #14 x 5/8" Sheet Metal Torx-T27 SS</td><td>2</td></tr> <tr><td>m</td><td>FAST-S0027</td><td>Screw #10-24 x 2" Flat Machine Torx SS</td><td>2</td></tr> </tbody> </table> <p>NOTE: Torx bits are not included but can be ordered separately.</p>	Includes:				Part No.	Description	Qty.		a	HDWC-S0211	Surface-Mounted Hinge (LHI/RHO)	1	b	HDWL-S160	Slide Latch	1	c	HDWC-S919	Door Stop Inswing	1	d	HDWL-S918	Door Keeper	1	e	HDWT-S275	Coat Hook Outswing	1	f	HDWT-S282	Door Pull	1	g	HDWT-S177	Wall Bumper	1	h	HDW0-S0167	Door Pull with Countersink SS	1	i	FAST-S0017	Screw #10-24 x 1/2" BTN Barrel-Female w/Pin SS	10	j	FAST-S0019	Screw #10 x 5/8" BTN Sheet Metal Torx-T25 w/Pin SS	6	k	FAST-P004	Screw #10-24 x 3/4" BTN Step-Male Torx-T27	10	l	FAST-S0016	Screw #14 x 5/8" Sheet Metal Torx-T27 SS	2	m	FAST-S0027	Screw #10-24 x 2" Flat Machine Torx SS	2	\$ 117.00
Includes:																																																														
Part No.	Description	Qty.																																																												
a	HDWC-S0211	Surface-Mounted Hinge (LHI/RHO)	1																																																											
b	HDWL-S160	Slide Latch	1																																																											
c	HDWC-S919	Door Stop Inswing	1																																																											
d	HDWL-S918	Door Keeper	1																																																											
e	HDWT-S275	Coat Hook Outswing	1																																																											
f	HDWT-S282	Door Pull	1																																																											
g	HDWT-S177	Wall Bumper	1																																																											
h	HDW0-S0167	Door Pull with Countersink SS	1																																																											
i	FAST-S0017	Screw #10-24 x 1/2" BTN Barrel-Female w/Pin SS	10																																																											
j	FAST-S0019	Screw #10 x 5/8" BTN Sheet Metal Torx-T25 w/Pin SS	6																																																											
k	FAST-P004	Screw #10-24 x 3/4" BTN Step-Male Torx-T27	10																																																											
l	FAST-S0016	Screw #14 x 5/8" Sheet Metal Torx-T27 SS	2																																																											
m	FAST-S0027	Screw #10-24 x 2" Flat Machine Torx SS	2																																																											
	<table border="1"> <thead> <tr> <th colspan="4">Includes:</th> </tr> <tr> <th>Part No.</th> <th>Description</th> <th>Qty.</th> <th></th> </tr> </thead> <tbody> <tr><td>a</td><td>HDWC-S0211</td><td>Surface-Mounted Hinge (LHI/RHO)</td><td>1</td></tr> <tr><td>b</td><td>HDWL-S160</td><td>Slide Latch</td><td>1</td></tr> <tr><td>c</td><td>HDWC-S0029</td><td>Flat Door Stop/Keeper</td><td>1</td></tr> <tr><td>d</td><td>HDWT-S275</td><td>Coat Hook Outswing</td><td>1</td></tr> <tr><td>e</td><td>HDWT-S282</td><td>Door Pull</td><td>1</td></tr> <tr><td>f</td><td>HDWT-S177</td><td>Wall Bumper</td><td>1</td></tr> <tr><td>g</td><td>HDW0-S0167</td><td>Door Pull with Countersink SS</td><td>1</td></tr> <tr><td>h</td><td>FAST-S0017</td><td>Screw #10-24 x 1/2" BTN Barrel-Female w/Pin SS</td><td>8</td></tr> <tr><td>i</td><td>FAST-S0019</td><td>Screw #10 x 5/8" BTN Sheet Metal Torx-T25 w/Pin SS</td><td>6</td></tr> <tr><td>j</td><td>FAST-P004</td><td>Screw #10-24 x 3/4" BTN Step-Male Torx-T27</td><td>8</td></tr> <tr><td>k</td><td>FAST-S0016</td><td>Screw #14 x 5/8" Sheet Metal Torx-T27 SS</td><td>2</td></tr> <tr><td>l</td><td>FAST-S0006</td><td>Screw #10 x 3/4" FL Sheet Metal Torx-T25</td><td>2</td></tr> <tr><td>m</td><td>FAST-S0027</td><td>Screw #10-24 x 2" Flat Machine Torx SS</td><td>2</td></tr> </tbody> </table> <p>NOTE: Torx bits are not included but can be ordered separately.</p>	Includes:				Part No.	Description	Qty.		a	HDWC-S0211	Surface-Mounted Hinge (LHI/RHO)	1	b	HDWL-S160	Slide Latch	1	c	HDWC-S0029	Flat Door Stop/Keeper	1	d	HDWT-S275	Coat Hook Outswing	1	e	HDWT-S282	Door Pull	1	f	HDWT-S177	Wall Bumper	1	g	HDW0-S0167	Door Pull with Countersink SS	1	h	FAST-S0017	Screw #10-24 x 1/2" BTN Barrel-Female w/Pin SS	8	i	FAST-S0019	Screw #10 x 5/8" BTN Sheet Metal Torx-T25 w/Pin SS	6	j	FAST-P004	Screw #10-24 x 3/4" BTN Step-Male Torx-T27	8	k	FAST-S0016	Screw #14 x 5/8" Sheet Metal Torx-T27 SS	2	l	FAST-S0006	Screw #10 x 3/4" FL Sheet Metal Torx-T25	2	m	FAST-S0027	Screw #10-24 x 2" Flat Machine Torx SS	2	\$ 117.00
Includes:																																																														
Part No.	Description	Qty.																																																												
a	HDWC-S0211	Surface-Mounted Hinge (LHI/RHO)	1																																																											
b	HDWL-S160	Slide Latch	1																																																											
c	HDWC-S0029	Flat Door Stop/Keeper	1																																																											
d	HDWT-S275	Coat Hook Outswing	1																																																											
e	HDWT-S282	Door Pull	1																																																											
f	HDWT-S177	Wall Bumper	1																																																											
g	HDW0-S0167	Door Pull with Countersink SS	1																																																											
h	FAST-S0017	Screw #10-24 x 1/2" BTN Barrel-Female w/Pin SS	8																																																											
i	FAST-S0019	Screw #10 x 5/8" BTN Sheet Metal Torx-T25 w/Pin SS	6																																																											
j	FAST-P004	Screw #10-24 x 3/4" BTN Step-Male Torx-T27	8																																																											
k	FAST-S0016	Screw #14 x 5/8" Sheet Metal Torx-T27 SS	2																																																											
l	FAST-S0006	Screw #10 x 3/4" FL Sheet Metal Torx-T25	2																																																											
m	FAST-S0027	Screw #10-24 x 2" Flat Machine Torx SS	2																																																											
	<table border="1"> <thead> <tr> <th colspan="4">Includes:</th> </tr> <tr> <th>Part No.</th> <th>Description</th> <th>Qty.</th> <th></th> </tr> </thead> <tbody> <tr><td>a</td><td>HDWC-S0212</td><td>Surface-Mounted Hinge (RHI/LHO)</td><td>1</td></tr> <tr><td>b</td><td>HDWL-S160</td><td>Slide Latch</td><td>1</td></tr> <tr><td>c</td><td>HDWC-S919</td><td>Door Stop Inswing</td><td>1</td></tr> <tr><td>d</td><td>HDWL-S918</td><td>Door Keeper</td><td>1</td></tr> <tr><td>e</td><td>HDWT-S275</td><td>Coat Hook Outswing</td><td>1</td></tr> <tr><td>f</td><td>HDWT-S282</td><td>Door Pull</td><td>1</td></tr> <tr><td>g</td><td>HDWT-S177</td><td>Wall Bumper</td><td>1</td></tr> <tr><td>h</td><td>HDW0-S0167</td><td>Door Pull with Countersink SS</td><td>1</td></tr> <tr><td>i</td><td>FAST-S0017</td><td>Screw #10-24 x 1/2" BTN Barrel-Female w/Pin SS</td><td>10</td></tr> <tr><td>j</td><td>FAST-S0019</td><td>Screw #10 x 5/8" BTN Sheet Metal Torx-T25 w/Pin SS</td><td>6</td></tr> <tr><td>k</td><td>FAST-P004</td><td>Screw #10-24 x 3/4" BTN Step-Male Torx-T27</td><td>10</td></tr> <tr><td>l</td><td>FAST-S0016</td><td>Screw #14 x 5/8" Sheet Metal Torx-T27 SS</td><td>2</td></tr> <tr><td>m</td><td>FAST-S0027</td><td>Screw #10-24 x 2" Flat Machine Torx SS</td><td>2</td></tr> </tbody> </table> <p>NOTE: Torx bits are not included but can be ordered separately.</p>	Includes:				Part No.	Description	Qty.		a	HDWC-S0212	Surface-Mounted Hinge (RHI/LHO)	1	b	HDWL-S160	Slide Latch	1	c	HDWC-S919	Door Stop Inswing	1	d	HDWL-S918	Door Keeper	1	e	HDWT-S275	Coat Hook Outswing	1	f	HDWT-S282	Door Pull	1	g	HDWT-S177	Wall Bumper	1	h	HDW0-S0167	Door Pull with Countersink SS	1	i	FAST-S0017	Screw #10-24 x 1/2" BTN Barrel-Female w/Pin SS	10	j	FAST-S0019	Screw #10 x 5/8" BTN Sheet Metal Torx-T25 w/Pin SS	6	k	FAST-P004	Screw #10-24 x 3/4" BTN Step-Male Torx-T27	10	l	FAST-S0016	Screw #14 x 5/8" Sheet Metal Torx-T27 SS	2	m	FAST-S0027	Screw #10-24 x 2" Flat Machine Torx SS	2	\$ 117.00
Includes:																																																														
Part No.	Description	Qty.																																																												
a	HDWC-S0212	Surface-Mounted Hinge (RHI/LHO)	1																																																											
b	HDWL-S160	Slide Latch	1																																																											
c	HDWC-S919	Door Stop Inswing	1																																																											
d	HDWL-S918	Door Keeper	1																																																											
e	HDWT-S275	Coat Hook Outswing	1																																																											
f	HDWT-S282	Door Pull	1																																																											
g	HDWT-S177	Wall Bumper	1																																																											
h	HDW0-S0167	Door Pull with Countersink SS	1																																																											
i	FAST-S0017	Screw #10-24 x 1/2" BTN Barrel-Female w/Pin SS	10																																																											
j	FAST-S0019	Screw #10 x 5/8" BTN Sheet Metal Torx-T25 w/Pin SS	6																																																											
k	FAST-P004	Screw #10-24 x 3/4" BTN Step-Male Torx-T27	10																																																											
l	FAST-S0016	Screw #14 x 5/8" Sheet Metal Torx-T27 SS	2																																																											
m	FAST-S0027	Screw #10-24 x 2" Flat Machine Torx SS	2																																																											

Prices subject to change without notice.
 Items may be changed or discontinued
 without notice and without incurring obligation.

Effective Date April 1, 2018

Inswing Door Kits

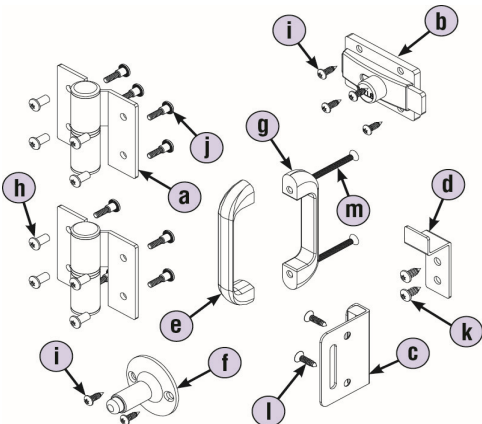
	5 Inswing ADA Door Kit with Flat Strike (right-hand)		HDWC-SD1-RHHCFS	List Price
				\$ 117.00
Includes:				
	Part No.	Description	Qty.	
a	HDWC-S0212	Surface-Mounted Hinge (RHI/LHO)	1	
b	HDWL-S160	Slide Latch	1	
c	HDWC-S0029	Flat Door Stop/Keeper	1	
d	HDWT-S275	Coat Hook Outswing	1	
e	HDWT-S282	Door Pull	1	
f	HDWT-S177	Wall Bumper	1	
g	HDW0-S0167	Door Pull with Countersink SS	1	
h	FAST-S0017	Screw #10-24 x 1/2" BTN Barrel-Female w/Pin SS	8	
i	FAST-S0019	Screw #10 x 5/8" BTN Sheet Metal Torx-T25 w/Pin SS	6	
j	FAST-P004	Screw #10-24 x 3/4" BTN Step-Male Torx-T27	8	
k	FAST-S0016	Screw #14 x 5/8" Sheet Metal Torx-T27 SS	2	
l	FAST-S0006	Screw #10 x 3/4" FL Sheet Metal Torx-T25	2	
m	FAST-S0027	Screw #10-24 x 2" Flat Machine Torx SS	2	

NOTE: Torx bits are not included but can be ordered separately.

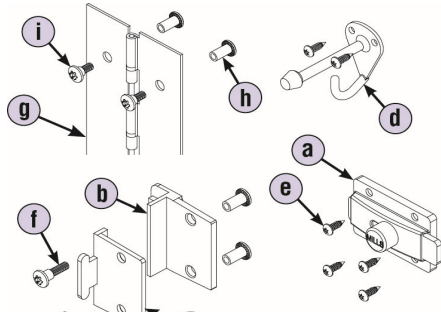
	5 Inswing Door Kit w/Piano Hinge (RHI/LHO)		HDWC-S0234	List Price
				\$ 198.00
Includes:				
	Part No.	Description	Qty.	
a	HDWL-S160	Slide Latch	1	
b	HDWC-S919	Door Stop	1	
c	HDWL-S918	Door Keeper	1	
d	HDWL-S285	Coat Hook with Bumper	1	
e	FAST-S0019	Screw #10 x 5/8" BTN Sheet Metal Torx-T25 w/Pin SS	6	
f	FAST-P004	Screw #10-24 x 3/4" BTN Step-Male Torx-T27	2	
g	HDWT-S0208	Piano Hinge, Continuous Stainless Steel (RHI/LHO)	1	
h	FAST-S0017	Screw #10-24 x 1/2" BTN Barrel-Female w/Pin SS	14	
i	FAST-S0018	Screw #10-24 x 1/2" Shoulder Torx-T27 SS	12	

NOTE: Torx bits are not included but can be ordered separately.

	5 Inswing Flat Strike Door Kit w/Piano Hinge (RHI/LHO)		HDWC-S0238	List Price
				\$ 198.00
Includes:				
	Part No.	Description	Qty.	
a	HDWL-S160	Slide Latch	1	
b	HDWC-S0029	Flat Door Stop/Keeper	1	
c	HDWT-S285	Coat Hook with Bumper	1	
d	FAST-S0019	Screw #10 x 5/8" BTN Sheet Metal Torx-T25 w/Pin SS	6	
e	FAST-S0006	Screw #10 x 3/4" FL Sheet Metal Torx-T25	2	
f	HDWT-S0208	Piano Hinge, Continuous Stainless Steel (RHI/LHO)	1	
g	FAST-S0017	Screw #10-24 x 1/2" BTN Barrel-Female w/Pin SS	12	
h	FAST-S0018	Screw #10-24 x 1/2" Shoulder Torx-T27 SS	12	

NOTE: Torx bits are not included but can be ordered separately.

Effective Date April 1, 2018

Inswing Door Kits

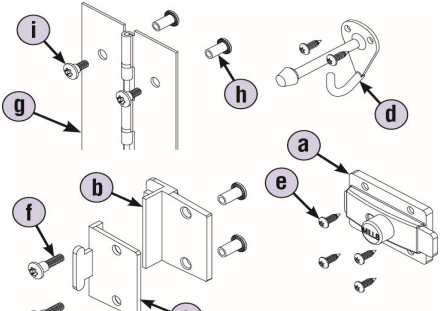
	5 Inswing Door Kit w/Piano Hinge (LHI/RHO)			HDWC-S0236	List Price \$ 198.00																												
	Includes:																																
	<table border="1"> <thead> <tr> <th>Part No.</th> <th>Description</th> <th>Qty.</th> </tr> </thead> <tbody> <tr> <td>a</td> <td>HDWL-S160 Slide Latch</td> <td>1</td> </tr> <tr> <td>b</td> <td>HDWC-S919 Door Stop</td> <td>1</td> </tr> <tr> <td>c</td> <td>HDWL-S918 Door Keeper</td> <td>1</td> </tr> <tr> <td>d</td> <td>HDWT-S285 Coat Hook with Bumper</td> <td>1</td> </tr> <tr> <td>e</td> <td>FAST-S0019 Screw #10 x 5/8" BTN Sheet Metal Torx-T25 w/Pin SS</td> <td>6</td> </tr> <tr> <td>f</td> <td>FAST-P004 Screw #10-24 x 3/4" BTN Step-Male Torx-T27</td> <td>2</td> </tr> <tr> <td>g</td> <td>HDWT-S0209 Piano Hinge, Continuous Stainless Steel (LHI/RHO)</td> <td>1</td> </tr> <tr> <td>h</td> <td>FAST-S0017 Screw #10-24 x 1/2" BTN Barrel-Female w/Pin SS</td> <td>14</td> </tr> <tr> <td>i</td> <td>FAST-S0018 Screw #10-24 x 1/2" Shoulder Torx-T27 SS</td> <td>12</td> </tr> </tbody> </table>	Part No.	Description	Qty.	a	HDWL-S160 Slide Latch	1	b	HDWC-S919 Door Stop	1	c	HDWL-S918 Door Keeper	1	d	HDWT-S285 Coat Hook with Bumper	1	e	FAST-S0019 Screw #10 x 5/8" BTN Sheet Metal Torx-T25 w/Pin SS	6	f	FAST-P004 Screw #10-24 x 3/4" BTN Step-Male Torx-T27	2	g	HDWT-S0209 Piano Hinge, Continuous Stainless Steel (LHI/RHO)	1	h	FAST-S0017 Screw #10-24 x 1/2" BTN Barrel-Female w/Pin SS	14	i	FAST-S0018 Screw #10-24 x 1/2" Shoulder Torx-T27 SS	12		
Part No.	Description	Qty.																															
a	HDWL-S160 Slide Latch	1																															
b	HDWC-S919 Door Stop	1																															
c	HDWL-S918 Door Keeper	1																															
d	HDWT-S285 Coat Hook with Bumper	1																															
e	FAST-S0019 Screw #10 x 5/8" BTN Sheet Metal Torx-T25 w/Pin SS	6																															
f	FAST-P004 Screw #10-24 x 3/4" BTN Step-Male Torx-T27	2																															
g	HDWT-S0209 Piano Hinge, Continuous Stainless Steel (LHI/RHO)	1																															
h	FAST-S0017 Screw #10-24 x 1/2" BTN Barrel-Female w/Pin SS	14																															
i	FAST-S0018 Screw #10-24 x 1/2" Shoulder Torx-T27 SS	12																															

NOTE: Torx bits are not included but can be ordered separately.

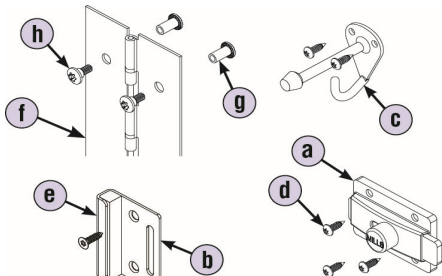
	5 Inswing Flat Strike Door Kit w/Piano Hinge (LHI/RHO)			HDWC-S0240	List Price \$ 198.00																									
	Includes:																													
	<table border="1"> <thead> <tr> <th>Part No.</th> <th>Description</th> <th>Qty.</th> </tr> </thead> <tbody> <tr> <td>a</td> <td>HDWL-S160 Slide Latch</td> <td>1</td> </tr> <tr> <td>b</td> <td>HDWC-S0029 Flat Door Stop/Keeper</td> <td>1</td> </tr> <tr> <td>c</td> <td>HDWT-S285 Coat Hook with Bumper</td> <td>1</td> </tr> <tr> <td>d</td> <td>FAST-S0019 Screw #10 x 5/8" BTN Sheet Metal Torx-T25 w/Pin SS</td> <td>6</td> </tr> <tr> <td>e</td> <td>FAST-S0006 Screw #10 x 3/4" FL Sheet Metal Torx-T25</td> <td>2</td> </tr> <tr> <td>f</td> <td>HDWT-S0209 Piano Hinge, Continuous Stainless Steel (LHI/RHO)</td> <td>1</td> </tr> <tr> <td>g</td> <td>FAST-S0017 Screw #10-24 x 1/2" BTN Barrel-Female w/Pin SS</td> <td>12</td> </tr> <tr> <td>h</td> <td>FAST-S0018 Screw #10-24 x 1/2" Shoulder Torx-T27 SS</td> <td>12</td> </tr> </tbody> </table>	Part No.	Description	Qty.	a	HDWL-S160 Slide Latch	1	b	HDWC-S0029 Flat Door Stop/Keeper	1	c	HDWT-S285 Coat Hook with Bumper	1	d	FAST-S0019 Screw #10 x 5/8" BTN Sheet Metal Torx-T25 w/Pin SS	6	e	FAST-S0006 Screw #10 x 3/4" FL Sheet Metal Torx-T25	2	f	HDWT-S0209 Piano Hinge, Continuous Stainless Steel (LHI/RHO)	1	g	FAST-S0017 Screw #10-24 x 1/2" BTN Barrel-Female w/Pin SS	12	h	FAST-S0018 Screw #10-24 x 1/2" Shoulder Torx-T27 SS	12		
Part No.	Description	Qty.																												
a	HDWL-S160 Slide Latch	1																												
b	HDWC-S0029 Flat Door Stop/Keeper	1																												
c	HDWT-S285 Coat Hook with Bumper	1																												
d	FAST-S0019 Screw #10 x 5/8" BTN Sheet Metal Torx-T25 w/Pin SS	6																												
e	FAST-S0006 Screw #10 x 3/4" FL Sheet Metal Torx-T25	2																												
f	HDWT-S0209 Piano Hinge, Continuous Stainless Steel (LHI/RHO)	1																												
g	FAST-S0017 Screw #10-24 x 1/2" BTN Barrel-Female w/Pin SS	12																												
h	FAST-S0018 Screw #10-24 x 1/2" Shoulder Torx-T27 SS	12																												

NOTE: Torx bits are not included but can be ordered separately.

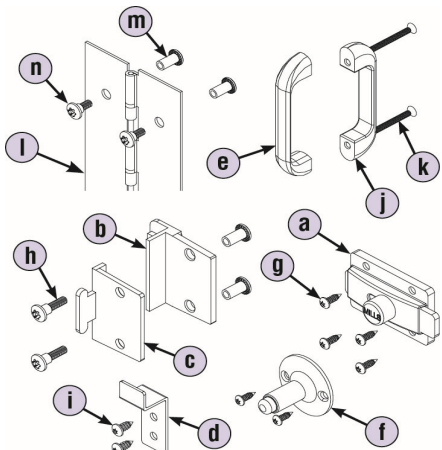
	5 Inswing ADA Door Kit w/Piano Hinge (RHI/LHO)			HDWC-S0242	List Price \$ 220.00																																											
	Includes:																																															
	<table border="1"> <thead> <tr> <th>Part No.</th> <th>Description</th> <th>Qty.</th> </tr> </thead> <tbody> <tr> <td>a</td> <td>HDWL-S160 Slide Latch</td> <td>1</td> </tr> <tr> <td>b</td> <td>HDWC-S919 Door Stop</td> <td>1</td> </tr> <tr> <td>c</td> <td>HDWL-S918 Door Keeper</td> <td>1</td> </tr> <tr> <td>d</td> <td>HDWT-S275 Coat Hook Outswing</td> <td>1</td> </tr> <tr> <td>e</td> <td>HDWT-S282 Door Pull</td> <td>1</td> </tr> <tr> <td>f</td> <td>HDWT-S177 Wall Bumper</td> <td>1</td> </tr> <tr> <td>g</td> <td>FAST-S0019 Screw #10 x 5/8" BTN Sheet Metal Torx-T25 w/Pin SS</td> <td>6</td> </tr> <tr> <td>h</td> <td>FAST-P004 Screw #10-24 x 3/4" BTN Step-Male Torx-T27</td> <td>2</td> </tr> <tr> <td>i</td> <td>FAST-S0016 Screw #14 x 5/8" Sheet Metal Torx-T27 SS</td> <td>2</td> </tr> <tr> <td>j</td> <td>HDW0-S0167 Door Pull with Countersink SS</td> <td>1</td> </tr> <tr> <td>k</td> <td>FAST-S0027 Screw #10-24 x 2" Flat Machine Torx SS</td> <td>2</td> </tr> <tr> <td>l</td> <td>HDWT-S0208 Piano Hinge, Continuous Stainless Steel (RHI/LHO)</td> <td>1</td> </tr> <tr> <td>m</td> <td>FAST-S0017 Screw #10-24 x 1/2" BTN Barrel-Female w/Pin SS</td> <td>14</td> </tr> <tr> <td>n</td> <td>FAST-S0018 Screw #10-24 x 1/2" Shoulder Torx-T27 SS</td> <td>12</td> </tr> </tbody> </table>	Part No.	Description	Qty.	a	HDWL-S160 Slide Latch	1	b	HDWC-S919 Door Stop	1	c	HDWL-S918 Door Keeper	1	d	HDWT-S275 Coat Hook Outswing	1	e	HDWT-S282 Door Pull	1	f	HDWT-S177 Wall Bumper	1	g	FAST-S0019 Screw #10 x 5/8" BTN Sheet Metal Torx-T25 w/Pin SS	6	h	FAST-P004 Screw #10-24 x 3/4" BTN Step-Male Torx-T27	2	i	FAST-S0016 Screw #14 x 5/8" Sheet Metal Torx-T27 SS	2	j	HDW0-S0167 Door Pull with Countersink SS	1	k	FAST-S0027 Screw #10-24 x 2" Flat Machine Torx SS	2	l	HDWT-S0208 Piano Hinge, Continuous Stainless Steel (RHI/LHO)	1	m	FAST-S0017 Screw #10-24 x 1/2" BTN Barrel-Female w/Pin SS	14	n	FAST-S0018 Screw #10-24 x 1/2" Shoulder Torx-T27 SS	12		
Part No.	Description	Qty.																																														
a	HDWL-S160 Slide Latch	1																																														
b	HDWC-S919 Door Stop	1																																														
c	HDWL-S918 Door Keeper	1																																														
d	HDWT-S275 Coat Hook Outswing	1																																														
e	HDWT-S282 Door Pull	1																																														
f	HDWT-S177 Wall Bumper	1																																														
g	FAST-S0019 Screw #10 x 5/8" BTN Sheet Metal Torx-T25 w/Pin SS	6																																														
h	FAST-P004 Screw #10-24 x 3/4" BTN Step-Male Torx-T27	2																																														
i	FAST-S0016 Screw #14 x 5/8" Sheet Metal Torx-T27 SS	2																																														
j	HDW0-S0167 Door Pull with Countersink SS	1																																														
k	FAST-S0027 Screw #10-24 x 2" Flat Machine Torx SS	2																																														
l	HDWT-S0208 Piano Hinge, Continuous Stainless Steel (RHI/LHO)	1																																														
m	FAST-S0017 Screw #10-24 x 1/2" BTN Barrel-Female w/Pin SS	14																																														
n	FAST-S0018 Screw #10-24 x 1/2" Shoulder Torx-T27 SS	12																																														

NOTE: Torx bits are not included but can be ordered separately.

Effective Date April 1, 2018

Inswing Door Kits

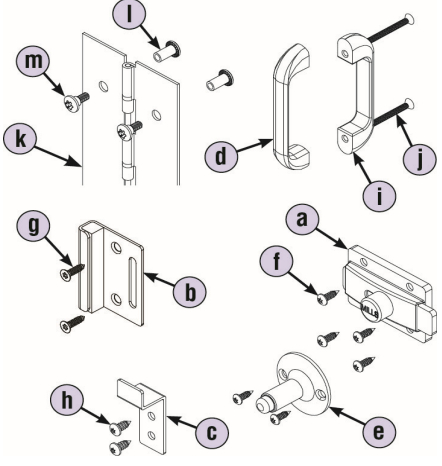
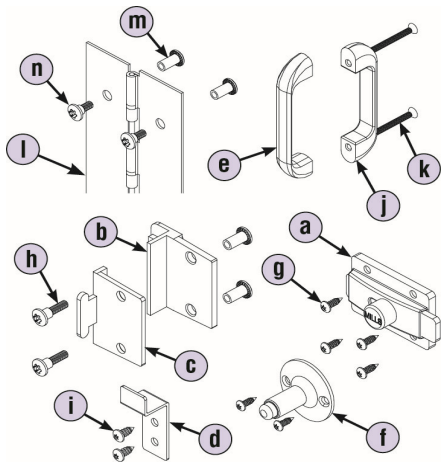
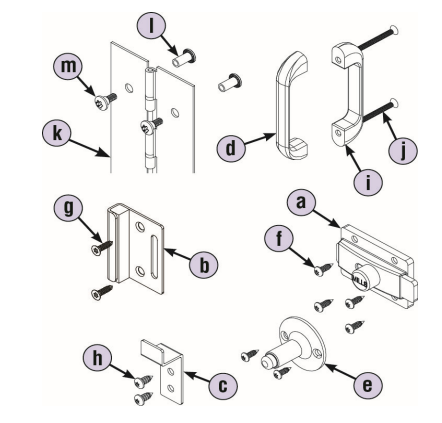
 5 Inswing ADA Flat Strike Door Kit w/Piano Hinge (RHI/LHO)	HDWC-S0244	List Price																																																											
	Includes:	\$ 220.00																																																											
	<table border="1"> <thead> <tr> <th>Part No.</th> <th>Description</th> <th>Qty.</th> </tr> </thead> <tbody> <tr><td>a</td><td>HDWL-S160</td><td>Slide Latch</td><td>1</td></tr> <tr><td>b</td><td>HDWC-S0029</td><td>Flat Door Stop/Keeper</td><td>1</td></tr> <tr><td>c</td><td>HDWT-S275</td><td>Coat Hook Outswing</td><td>1</td></tr> <tr><td>d</td><td>HDWT-S282</td><td>Door Pull</td><td>1</td></tr> <tr><td>e</td><td>HDWT-S177</td><td>Wall Bumper</td><td>1</td></tr> <tr><td>f</td><td>FAST-S0019</td><td>Screw #10 x 3/8" BTN Sheet Metal Torx-T25 w/Pin SS</td><td>6</td></tr> <tr><td>g</td><td>FAST-S0006</td><td>Screw #10 x 3/4" FL Sheet Metal Torx-T25</td><td>2</td></tr> <tr><td>h</td><td>FAST-S0016</td><td>Screw #14 x 3/8" Sheet Metal Torx-T27 SS</td><td>2</td></tr> <tr><td>i</td><td>HDW0-S0167</td><td>Door Pull with Countersink SS</td><td>1</td></tr> <tr><td>j</td><td>FAST-S0027</td><td>Screw #10-24 x 2" Flat Machine Torx SS</td><td>2</td></tr> <tr><td>k</td><td>HDWT-S0208</td><td>Piano Hinge, Continuous Stainless Steel (RHI/LHO)</td><td>1</td></tr> <tr><td>l</td><td>FAST-S0017</td><td>Screw #10-24 x 1/2" BTN Barrel-Female w/Pin SS</td><td>12</td></tr> <tr><td>m</td><td>FAST-S0018</td><td>Screw #10-24 x 1/2" Shoulder Torx-T27 SS</td><td>12</td></tr> </tbody> </table>	Part No.	Description	Qty.	a	HDWL-S160	Slide Latch	1	b	HDWC-S0029	Flat Door Stop/Keeper	1	c	HDWT-S275	Coat Hook Outswing	1	d	HDWT-S282	Door Pull	1	e	HDWT-S177	Wall Bumper	1	f	FAST-S0019	Screw #10 x 3/8" BTN Sheet Metal Torx-T25 w/Pin SS	6	g	FAST-S0006	Screw #10 x 3/4" FL Sheet Metal Torx-T25	2	h	FAST-S0016	Screw #14 x 3/8" Sheet Metal Torx-T27 SS	2	i	HDW0-S0167	Door Pull with Countersink SS	1	j	FAST-S0027	Screw #10-24 x 2" Flat Machine Torx SS	2	k	HDWT-S0208	Piano Hinge, Continuous Stainless Steel (RHI/LHO)	1	l	FAST-S0017	Screw #10-24 x 1/2" BTN Barrel-Female w/Pin SS	12	m	FAST-S0018	Screw #10-24 x 1/2" Shoulder Torx-T27 SS	12					
Part No.	Description	Qty.																																																											
a	HDWL-S160	Slide Latch	1																																																										
b	HDWC-S0029	Flat Door Stop/Keeper	1																																																										
c	HDWT-S275	Coat Hook Outswing	1																																																										
d	HDWT-S282	Door Pull	1																																																										
e	HDWT-S177	Wall Bumper	1																																																										
f	FAST-S0019	Screw #10 x 3/8" BTN Sheet Metal Torx-T25 w/Pin SS	6																																																										
g	FAST-S0006	Screw #10 x 3/4" FL Sheet Metal Torx-T25	2																																																										
h	FAST-S0016	Screw #14 x 3/8" Sheet Metal Torx-T27 SS	2																																																										
i	HDW0-S0167	Door Pull with Countersink SS	1																																																										
j	FAST-S0027	Screw #10-24 x 2" Flat Machine Torx SS	2																																																										
k	HDWT-S0208	Piano Hinge, Continuous Stainless Steel (RHI/LHO)	1																																																										
l	FAST-S0017	Screw #10-24 x 1/2" BTN Barrel-Female w/Pin SS	12																																																										
m	FAST-S0018	Screw #10-24 x 1/2" Shoulder Torx-T27 SS	12																																																										
	NOTE: Torx bits are not included but can be ordered separately.																																																												
 5 Inswing ADA Door Kit w/Piano Hinge (LHI/RHO)	HDWC-S0243	List Price																																																											
	Includes:	\$ 220.00																																																											
	<table border="1"> <thead> <tr> <th>Part No.</th> <th>Description</th> <th>Qty.</th> </tr> </thead> <tbody> <tr><td>a</td><td>HDWL-S160</td><td>Slide Latch</td><td>1</td></tr> <tr><td>b</td><td>HDWC-S919</td><td>Door Stop</td><td>1</td></tr> <tr><td>c</td><td>HDWL-S918</td><td>Door Keeper</td><td>1</td></tr> <tr><td>d</td><td>HDWT-S275</td><td>Coat Hook Outswing</td><td>1</td></tr> <tr><td>e</td><td>HDWT-S282</td><td>Door Pull</td><td>1</td></tr> <tr><td>f</td><td>HDWT-S177</td><td>Wall Bumper</td><td>1</td></tr> <tr><td>g</td><td>FAST-S0019</td><td>Screw #10 x 3/8" BTN Sheet Metal Torx-T25 w/Pin SS</td><td>6</td></tr> <tr><td>h</td><td>FAST-P004</td><td>Screw #10-24 x 3/4" BTN Step-Male Torx-T27</td><td>2</td></tr> <tr><td>i</td><td>FAST-S0016</td><td>Screw #14 x 3/8" Sheet Metal Torx-T27 SS</td><td>2</td></tr> <tr><td>j</td><td>HDW0-S0167</td><td>Door Pull with Countersink SS</td><td>1</td></tr> <tr><td>k</td><td>FAST-S0027</td><td>Screw #10-24 x 2" Flat Machine Torx SS</td><td>2</td></tr> <tr><td>l</td><td>HDWT-S0209</td><td>Piano Hinge, Continuous Stainless Steel (LHI/RHO)</td><td>1</td></tr> <tr><td>m</td><td>FAST-S0017</td><td>Screw #10-24 x 1/2" BTN Barrel-Female w/Pin SS</td><td>14</td></tr> <tr><td>n</td><td>FAST-S0018</td><td>Screw #10-24 x 1/2" Shoulder Torx-T27 SS</td><td>12</td></tr> </tbody> </table>	Part No.	Description	Qty.	a	HDWL-S160	Slide Latch	1	b	HDWC-S919	Door Stop	1	c	HDWL-S918	Door Keeper	1	d	HDWT-S275	Coat Hook Outswing	1	e	HDWT-S282	Door Pull	1	f	HDWT-S177	Wall Bumper	1	g	FAST-S0019	Screw #10 x 3/8" BTN Sheet Metal Torx-T25 w/Pin SS	6	h	FAST-P004	Screw #10-24 x 3/4" BTN Step-Male Torx-T27	2	i	FAST-S0016	Screw #14 x 3/8" Sheet Metal Torx-T27 SS	2	j	HDW0-S0167	Door Pull with Countersink SS	1	k	FAST-S0027	Screw #10-24 x 2" Flat Machine Torx SS	2	l	HDWT-S0209	Piano Hinge, Continuous Stainless Steel (LHI/RHO)	1	m	FAST-S0017	Screw #10-24 x 1/2" BTN Barrel-Female w/Pin SS	14	n	FAST-S0018	Screw #10-24 x 1/2" Shoulder Torx-T27 SS	12	
Part No.	Description	Qty.																																																											
a	HDWL-S160	Slide Latch	1																																																										
b	HDWC-S919	Door Stop	1																																																										
c	HDWL-S918	Door Keeper	1																																																										
d	HDWT-S275	Coat Hook Outswing	1																																																										
e	HDWT-S282	Door Pull	1																																																										
f	HDWT-S177	Wall Bumper	1																																																										
g	FAST-S0019	Screw #10 x 3/8" BTN Sheet Metal Torx-T25 w/Pin SS	6																																																										
h	FAST-P004	Screw #10-24 x 3/4" BTN Step-Male Torx-T27	2																																																										
i	FAST-S0016	Screw #14 x 3/8" Sheet Metal Torx-T27 SS	2																																																										
j	HDW0-S0167	Door Pull with Countersink SS	1																																																										
k	FAST-S0027	Screw #10-24 x 2" Flat Machine Torx SS	2																																																										
l	HDWT-S0209	Piano Hinge, Continuous Stainless Steel (LHI/RHO)	1																																																										
m	FAST-S0017	Screw #10-24 x 1/2" BTN Barrel-Female w/Pin SS	14																																																										
n	FAST-S0018	Screw #10-24 x 1/2" Shoulder Torx-T27 SS	12																																																										
	NOTE: Torx bits are not included but can be ordered separately.																																																												
 5 Inswing ADA Flat Strike Door Kit w/Piano Hinge (LHI/RHO)	HDWC-S0245	List Price																																																											
	Includes:	\$ 220.00																																																											
	<table border="1"> <thead> <tr> <th>Part No.</th> <th>Description</th> <th>Qty.</th> </tr> </thead> <tbody> <tr><td>a</td><td>HDWL-S160</td><td>Slide Latch</td><td>1</td></tr> <tr><td>b</td><td>HDWC-S0029</td><td>Flat Door Stop/Keeper</td><td>1</td></tr> <tr><td>c</td><td>HDWT-S275</td><td>Coat Hook Outswing</td><td>1</td></tr> <tr><td>d</td><td>HDWT-S282</td><td>Door Pull</td><td>1</td></tr> <tr><td>e</td><td>HDWT-S177</td><td>Wall Bumper</td><td>1</td></tr> <tr><td>f</td><td>FAST-S0019</td><td>Screw #10 x 3/8" BTN Sheet Metal Torx-T25 w/Pin SS</td><td>6</td></tr> <tr><td>g</td><td>FAST-S0006</td><td>Screw #10 x 3/4" FL Sheet Metal Torx-T25</td><td>2</td></tr> <tr><td>h</td><td>FAST-S0016</td><td>Screw #14 x 3/8" Sheet Metal Torx-T27 SS</td><td>2</td></tr> <tr><td>i</td><td>HDW0-S0167</td><td>Door Pull with Countersink SS</td><td>1</td></tr> <tr><td>j</td><td>FAST-S0027</td><td>Screw #10-24 x 2" Flat Machine Torx SS</td><td>2</td></tr> <tr><td>k</td><td>HDWT-S0209</td><td>Piano Hinge, Continuous Stainless Steel (LHI/RHO)</td><td>1</td></tr> <tr><td>l</td><td>FAST-S0017</td><td>Screw #10-24 x 1/2" BTN Barrel-Female w/Pin SS</td><td>12</td></tr> <tr><td>m</td><td>FAST-S0018</td><td>Screw #10-24 x 1/2" Shoulder Torx-T27 SS</td><td>12</td></tr> </tbody> </table>	Part No.	Description	Qty.	a	HDWL-S160	Slide Latch	1	b	HDWC-S0029	Flat Door Stop/Keeper	1	c	HDWT-S275	Coat Hook Outswing	1	d	HDWT-S282	Door Pull	1	e	HDWT-S177	Wall Bumper	1	f	FAST-S0019	Screw #10 x 3/8" BTN Sheet Metal Torx-T25 w/Pin SS	6	g	FAST-S0006	Screw #10 x 3/4" FL Sheet Metal Torx-T25	2	h	FAST-S0016	Screw #14 x 3/8" Sheet Metal Torx-T27 SS	2	i	HDW0-S0167	Door Pull with Countersink SS	1	j	FAST-S0027	Screw #10-24 x 2" Flat Machine Torx SS	2	k	HDWT-S0209	Piano Hinge, Continuous Stainless Steel (LHI/RHO)	1	l	FAST-S0017	Screw #10-24 x 1/2" BTN Barrel-Female w/Pin SS	12	m	FAST-S0018	Screw #10-24 x 1/2" Shoulder Torx-T27 SS	12					
Part No.	Description	Qty.																																																											
a	HDWL-S160	Slide Latch	1																																																										
b	HDWC-S0029	Flat Door Stop/Keeper	1																																																										
c	HDWT-S275	Coat Hook Outswing	1																																																										
d	HDWT-S282	Door Pull	1																																																										
e	HDWT-S177	Wall Bumper	1																																																										
f	FAST-S0019	Screw #10 x 3/8" BTN Sheet Metal Torx-T25 w/Pin SS	6																																																										
g	FAST-S0006	Screw #10 x 3/4" FL Sheet Metal Torx-T25	2																																																										
h	FAST-S0016	Screw #14 x 3/8" Sheet Metal Torx-T27 SS	2																																																										
i	HDW0-S0167	Door Pull with Countersink SS	1																																																										
j	FAST-S0027	Screw #10-24 x 2" Flat Machine Torx SS	2																																																										
k	HDWT-S0209	Piano Hinge, Continuous Stainless Steel (LHI/RHO)	1																																																										
l	FAST-S0017	Screw #10-24 x 1/2" BTN Barrel-Female w/Pin SS	12																																																										
m	FAST-S0018	Screw #10-24 x 1/2" Shoulder Torx-T27 SS	12																																																										
	NOTE: Torx bits are not included but can be ordered separately.																																																												

Prices subject to change without notice.
Items may be changed or discontinued
without notice and without incurring obligation.

Effective Date April 1, 2018

Outswing Door Kits

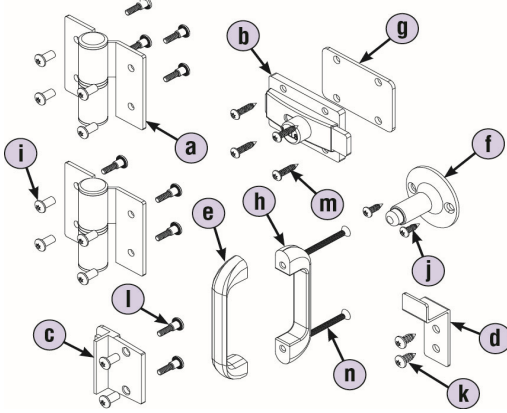
6 Outswing Door Kit (left-hand)	HDWC-SD2-LH	List Price																																													
	Includes:	\$ 113.00																																													
	<table border="1"> <thead> <tr> <th>Part No.</th> <th>Description</th> <th>Qty.</th> </tr> </thead> <tbody> <tr> <td>a</td> <td>HDWC-S0212 Surface-Mounted Hinge (RHI/LHO)</td> <td>1</td> </tr> <tr> <td>b</td> <td>HDWL-S160 Slide Latch</td> <td>1</td> </tr> <tr> <td>c</td> <td>HDWC-S919 Door Stop Inswing</td> <td>1</td> </tr> <tr> <td>d</td> <td>HDWT-S275 Coat Hook Outswing</td> <td>1</td> </tr> <tr> <td>e</td> <td>HDWT-S282 Door Pull</td> <td>1</td> </tr> <tr> <td>f</td> <td>HDWT-S177 Wall Bumper</td> <td>1</td> </tr> <tr> <td>g</td> <td>HDWL-P0036 Spacer</td> <td>1</td> </tr> <tr> <td>h</td> <td>HDW0-S0167 Door Pull with Countersink SS</td> <td>1</td> </tr> <tr> <td>i</td> <td>FAST-S0017 Screw #10-24 x 1/2" BTN Barrel-Female w/Pin SS</td> <td>10</td> </tr> <tr> <td>j</td> <td>FAST-S0019 Screw #10 x 5/8" BTN Sheet Metal Torx-T25 w/Pin SS</td> <td>2</td> </tr> <tr> <td>k</td> <td>FAST-S0016 Screw #14 x 5/8" Sheet Metal Torx-T27 SS</td> <td>2</td> </tr> <tr> <td>l</td> <td>FAST-P004 Screw #10-24 x 3/4" BTN Step-Male Torx-T27</td> <td>10</td> </tr> <tr> <td>m</td> <td>FAST-S0028 Screw #10-24 x 1" Sheet Metal Torx-T27 SS</td> <td>4</td> </tr> <tr> <td>n</td> <td>FAST-S0027 Screw #10-24 x 2" Flat Machine Torx SS</td> <td>2</td> </tr> </tbody> </table>	Part No.	Description	Qty.	a	HDWC-S0212 Surface-Mounted Hinge (RHI/LHO)	1	b	HDWL-S160 Slide Latch	1	c	HDWC-S919 Door Stop Inswing	1	d	HDWT-S275 Coat Hook Outswing	1	e	HDWT-S282 Door Pull	1	f	HDWT-S177 Wall Bumper	1	g	HDWL-P0036 Spacer	1	h	HDW0-S0167 Door Pull with Countersink SS	1	i	FAST-S0017 Screw #10-24 x 1/2" BTN Barrel-Female w/Pin SS	10	j	FAST-S0019 Screw #10 x 5/8" BTN Sheet Metal Torx-T25 w/Pin SS	2	k	FAST-S0016 Screw #14 x 5/8" Sheet Metal Torx-T27 SS	2	l	FAST-P004 Screw #10-24 x 3/4" BTN Step-Male Torx-T27	10	m	FAST-S0028 Screw #10-24 x 1" Sheet Metal Torx-T27 SS	4	n	FAST-S0027 Screw #10-24 x 2" Flat Machine Torx SS	2	
	Part No.	Description	Qty.																																												
	a	HDWC-S0212 Surface-Mounted Hinge (RHI/LHO)	1																																												
	b	HDWL-S160 Slide Latch	1																																												
	c	HDWC-S919 Door Stop Inswing	1																																												
	d	HDWT-S275 Coat Hook Outswing	1																																												
	e	HDWT-S282 Door Pull	1																																												
	f	HDWT-S177 Wall Bumper	1																																												
	g	HDWL-P0036 Spacer	1																																												
	h	HDW0-S0167 Door Pull with Countersink SS	1																																												
i	FAST-S0017 Screw #10-24 x 1/2" BTN Barrel-Female w/Pin SS	10																																													
j	FAST-S0019 Screw #10 x 5/8" BTN Sheet Metal Torx-T25 w/Pin SS	2																																													
k	FAST-S0016 Screw #14 x 5/8" Sheet Metal Torx-T27 SS	2																																													
l	FAST-P004 Screw #10-24 x 3/4" BTN Step-Male Torx-T27	10																																													
m	FAST-S0028 Screw #10-24 x 1" Sheet Metal Torx-T27 SS	4																																													
n	FAST-S0027 Screw #10-24 x 2" Flat Machine Torx SS	2																																													

NOTE: Torx bits are not included but can be ordered separately.

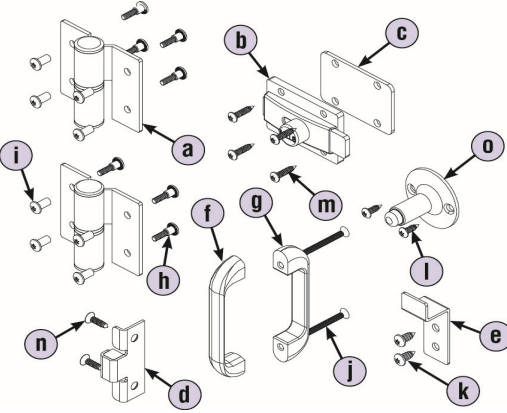
6 Outswing Door Kit with Flat Strike (left-hand)	HDWC-SD2-LHFS	List Price																																																
	Includes:	\$ 117.00																																																
	<table border="1"> <thead> <tr> <th>Part No.</th> <th>Description</th> <th>Qty.</th> </tr> </thead> <tbody> <tr> <td>a</td> <td>HDWC-S0212 Surface-Mounted Hinge (RHI/LHO)</td> <td>1</td> </tr> <tr> <td>b</td> <td>HDWL-S160 Slide Latch</td> <td>1</td> </tr> <tr> <td>c</td> <td>HDWL-P0036 Spacer</td> <td>1</td> </tr> <tr> <td>d</td> <td>HDWC-S0022 Flat Door Stop/Keeper</td> <td>1</td> </tr> <tr> <td>e</td> <td>HDWT-S275 Coat Hook Outswing</td> <td>1</td> </tr> <tr> <td>f</td> <td>HDWT-S282 Door Pull</td> <td>1</td> </tr> <tr> <td>g</td> <td>HDW0-S0167 Door Pull with Countersink SS</td> <td>1</td> </tr> <tr> <td>h</td> <td>FAST-P004 Screw #10-24 x 3/4" BTN Step-Male Torx-T27</td> <td>8</td> </tr> <tr> <td>i</td> <td>FAST-S0017 Screw #10-24 x 1/2" BTN Barrel-Female w/Pin SS</td> <td>8</td> </tr> <tr> <td>j</td> <td>FAST-S0027 Screw #10-24 x 2" Flat Machine Torx SS</td> <td>2</td> </tr> <tr> <td>k</td> <td>FAST-S0016 Screw #14 x 5/8" Sheet Metal Torx-T27 SS</td> <td>2</td> </tr> <tr> <td>l</td> <td>FAST-S0019 Screw #10 x 5/8" BTN Sheet Metal Torx-T25 w/Pin SS</td> <td>2</td> </tr> <tr> <td>m</td> <td>FAST-S0028 Screw #10-24 x 1" Sheet Metal Torx-T27 SS</td> <td>4</td> </tr> <tr> <td>n</td> <td>FAST-S0006 Screw #10 x 3/4" FL Sheet Metal Torx-T25</td> <td>2</td> </tr> <tr> <td>o</td> <td>HDWT-S177 Wall Bumper</td> <td>1</td> </tr> </tbody> </table>	Part No.	Description	Qty.	a	HDWC-S0212 Surface-Mounted Hinge (RHI/LHO)	1	b	HDWL-S160 Slide Latch	1	c	HDWL-P0036 Spacer	1	d	HDWC-S0022 Flat Door Stop/Keeper	1	e	HDWT-S275 Coat Hook Outswing	1	f	HDWT-S282 Door Pull	1	g	HDW0-S0167 Door Pull with Countersink SS	1	h	FAST-P004 Screw #10-24 x 3/4" BTN Step-Male Torx-T27	8	i	FAST-S0017 Screw #10-24 x 1/2" BTN Barrel-Female w/Pin SS	8	j	FAST-S0027 Screw #10-24 x 2" Flat Machine Torx SS	2	k	FAST-S0016 Screw #14 x 5/8" Sheet Metal Torx-T27 SS	2	l	FAST-S0019 Screw #10 x 5/8" BTN Sheet Metal Torx-T25 w/Pin SS	2	m	FAST-S0028 Screw #10-24 x 1" Sheet Metal Torx-T27 SS	4	n	FAST-S0006 Screw #10 x 3/4" FL Sheet Metal Torx-T25	2	o	HDWT-S177 Wall Bumper	1	
	Part No.	Description	Qty.																																															
	a	HDWC-S0212 Surface-Mounted Hinge (RHI/LHO)	1																																															
	b	HDWL-S160 Slide Latch	1																																															
	c	HDWL-P0036 Spacer	1																																															
	d	HDWC-S0022 Flat Door Stop/Keeper	1																																															
	e	HDWT-S275 Coat Hook Outswing	1																																															
	f	HDWT-S282 Door Pull	1																																															
	g	HDW0-S0167 Door Pull with Countersink SS	1																																															
	h	FAST-P004 Screw #10-24 x 3/4" BTN Step-Male Torx-T27	8																																															
i	FAST-S0017 Screw #10-24 x 1/2" BTN Barrel-Female w/Pin SS	8																																																
j	FAST-S0027 Screw #10-24 x 2" Flat Machine Torx SS	2																																																
k	FAST-S0016 Screw #14 x 5/8" Sheet Metal Torx-T27 SS	2																																																
l	FAST-S0019 Screw #10 x 5/8" BTN Sheet Metal Torx-T25 w/Pin SS	2																																																
m	FAST-S0028 Screw #10-24 x 1" Sheet Metal Torx-T27 SS	4																																																
n	FAST-S0006 Screw #10 x 3/4" FL Sheet Metal Torx-T25	2																																																
o	HDWT-S177 Wall Bumper	1																																																

NOTE: Torx bits are not included but can be ordered separately.

Effective Date April 1, 2018

Outswing Door Kits

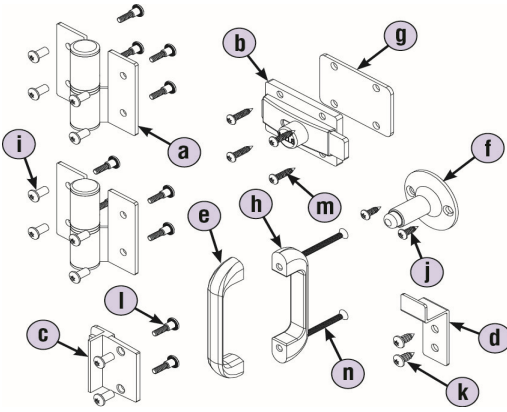
6 Outswing Door Kit (right-hand) 	HDWC-SD2-RH			List Price
	Includes:			\$ 113.00
	Part No.	Description	Qty.	
	a	HDWC-S0211 Surface-Mounted Hinge (LHI/RHO)	1	
	b	HDWL-S160 Slide Latch	1	
	c	HDWC-S919 Door Stop Inswing	1	
	d	HDWT-S275 Coat Hook Outswing	1	
	e	HDWT-S282 Door Pull	1	
	f	HDWT-S177 Wall Bumper	1	
	g	HDWL-P0036 Spacer	1	
	h	HDW0-S0167 Door Pull with Countersink SS	1	
	i	FAST-S0017 Screw #10-24 x 1/2" BTN Barrel-Female w/Pin SS	10	
	j	FAST-S0019 Screw #10 x 5/8" BTN Sheet Metal Torx-T25 w/Pin SS	2	
	k	FAST-S0016 Screw #14 x 5/8" Sheet Metal Torx-T27 SS	2	
	l	FAST-P004 Screw #10-24 x 3/4" BTN Step-Male Torx-T27	10	
	m	FAST-S0028 Screw #10-24 x 1" Sheet Metal Torx-T27 SS	4	
	n	FAST-S0027 Screw #10-24 x 2" Flat Machine Torx SS	2	

NOTE: Torx bits are not included but can be ordered separately.

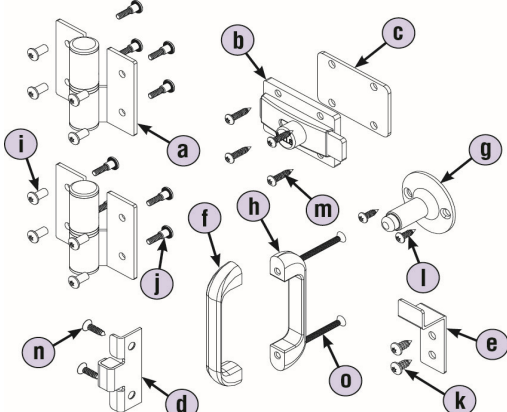
6 Outswing Door Kit with Flat Strike (right-hand) 	HDWC-SD2-RHFS			List Price
	Includes:			\$ 117.00
	Part No.	Description	Qty.	
	a	HDWC-S0211 Surface-Mounted Hinge (LHI/RHO)	1	
	b	HDWL-S160 Slide Latch	1	
	c	HDWL-P0036 Spacer	1	
	d	HDWC-S0022 Flat Door Stop/Keeper	1	
	e	HDWT-S275 Coat Hook Outswing	1	
	f	HDWT-S282 Door Pull	1	
	g	HDWT-S177 Wall Bumper	1	
	h	HDW0-S0167 Door Pull with Countersink SS	1	
	i	FAST-S0017 Screw #10-24 x 1/2" BTN Barrel-Female w/Pin SS	8	
	j	FAST-P004 Screw #10-24 x 3/4" BTN Step-Male Torx-T27	8	
	k	FAST-S0016 Screw #14 x 5/8" Sheet Metal Torx-T27 SS	2	
	l	FAST-S0019 Screw #10 x 5/8" BTN Sheet Metal Torx-T25 w/Pin SS	2	
	m	FAST-S0028 Screw #10-24 x 1" Sheet Metal Torx-T27 SS	4	
	n	FAST-S0006 Screw #10 x 3/4" FL Sheet Metal Torx-T25	2	
	o	FAST-S0027 Screw #10-24 x 2" Flat Machine Torx SS	2	

NOTE: Torx bits are not included but can be ordered separately.

Effective Date April 1, 2018

Outswing Door Kits

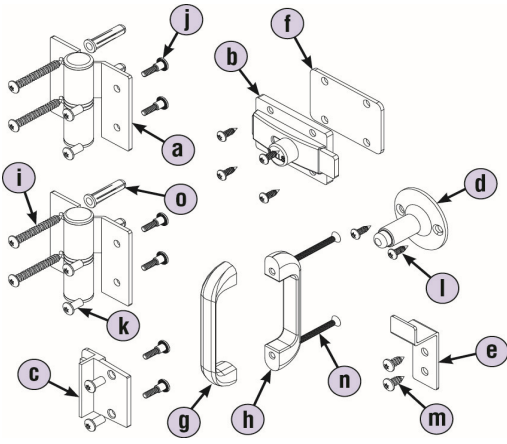
6 Outswing Door Kit with Wall Anchors (left-hand)	HDWC-SD2-LHFH	List Price																																																															
	Includes:	\$ 150.00																																																															
	<table border="1"> <thead> <tr> <th>Part No.</th> <th>Description</th> <th>Qty.</th> </tr> </thead> <tbody> <tr> <td>a</td> <td>HDWC-S0212</td> <td>Surface-Mounted Hinge (RHI/LHO)</td> <td>1</td> </tr> <tr> <td>b</td> <td>HDWL-S160</td> <td>Slide Latch</td> <td>1</td> </tr> <tr> <td>c</td> <td>HDWC-S919</td> <td>Door Stop Inswing</td> <td>1</td> </tr> <tr> <td>d</td> <td>HDWT-S177</td> <td>Wall Bumper</td> <td>1</td> </tr> <tr> <td>e</td> <td>HDWT-S275</td> <td>Coat Hook Outswing</td> <td>1</td> </tr> <tr> <td>f</td> <td>HDWL-P0036</td> <td>Spacer</td> <td>1</td> </tr> <tr> <td>g</td> <td>HDWT-S282</td> <td>Door Pull</td> <td>1</td> </tr> <tr> <td>h</td> <td>HDW0-S0167</td> <td>Door Pull with Countersink SS</td> <td>1</td> </tr> <tr> <td>i</td> <td>FAST-P002</td> <td>Screw #14 x 2" BTN Sheet Metal Torx-T27 w/Pin SS</td> <td>4</td> </tr> <tr> <td>j</td> <td>FAST-P004</td> <td>Screw #10-24 x 3/4" BTN Step-Male Torx-T27</td> <td>6</td> </tr> <tr> <td>k</td> <td>FAST-S0017</td> <td>Screw #10-24 x 1/2" BTN Barrel-Female w/Pin SS</td> <td>6</td> </tr> <tr> <td>l</td> <td>FAST-S0019</td> <td>Screw #10 x 5/8" BTN Sheet Metal Torx-T25 w/Pin SS</td> <td>6</td> </tr> <tr> <td>m</td> <td>FAST-S0016</td> <td>Screw #14 x 5/8" Sheet Metal Torx-T27 SS</td> <td>2</td> </tr> <tr> <td>n</td> <td>FAST-S0027</td> <td>Screw #10-24 x 2" Flat Machine Torx SS</td> <td>2</td> </tr> <tr> <td>o</td> <td>FAST-T373</td> <td>Anchor - Plastic #14-16 x 1 3/8" Lg.</td> <td>4</td> </tr> </tbody> </table>	Part No.	Description	Qty.	a	HDWC-S0212	Surface-Mounted Hinge (RHI/LHO)	1	b	HDWL-S160	Slide Latch	1	c	HDWC-S919	Door Stop Inswing	1	d	HDWT-S177	Wall Bumper	1	e	HDWT-S275	Coat Hook Outswing	1	f	HDWL-P0036	Spacer	1	g	HDWT-S282	Door Pull	1	h	HDW0-S0167	Door Pull with Countersink SS	1	i	FAST-P002	Screw #14 x 2" BTN Sheet Metal Torx-T27 w/Pin SS	4	j	FAST-P004	Screw #10-24 x 3/4" BTN Step-Male Torx-T27	6	k	FAST-S0017	Screw #10-24 x 1/2" BTN Barrel-Female w/Pin SS	6	l	FAST-S0019	Screw #10 x 5/8" BTN Sheet Metal Torx-T25 w/Pin SS	6	m	FAST-S0016	Screw #14 x 5/8" Sheet Metal Torx-T27 SS	2	n	FAST-S0027	Screw #10-24 x 2" Flat Machine Torx SS	2	o	FAST-T373	Anchor - Plastic #14-16 x 1 3/8" Lg.	4	
	Part No.	Description	Qty.																																																														
	a	HDWC-S0212	Surface-Mounted Hinge (RHI/LHO)	1																																																													
	b	HDWL-S160	Slide Latch	1																																																													
	c	HDWC-S919	Door Stop Inswing	1																																																													
	d	HDWT-S177	Wall Bumper	1																																																													
	e	HDWT-S275	Coat Hook Outswing	1																																																													
	f	HDWL-P0036	Spacer	1																																																													
	g	HDWT-S282	Door Pull	1																																																													
	h	HDW0-S0167	Door Pull with Countersink SS	1																																																													
	i	FAST-P002	Screw #14 x 2" BTN Sheet Metal Torx-T27 w/Pin SS	4																																																													
	j	FAST-P004	Screw #10-24 x 3/4" BTN Step-Male Torx-T27	6																																																													
	k	FAST-S0017	Screw #10-24 x 1/2" BTN Barrel-Female w/Pin SS	6																																																													
	l	FAST-S0019	Screw #10 x 5/8" BTN Sheet Metal Torx-T25 w/Pin SS	6																																																													
m	FAST-S0016	Screw #14 x 5/8" Sheet Metal Torx-T27 SS	2																																																														
n	FAST-S0027	Screw #10-24 x 2" Flat Machine Torx SS	2																																																														
o	FAST-T373	Anchor - Plastic #14-16 x 1 3/8" Lg.	4																																																														

NOTE: Torx bits are not included but can be ordered separately.

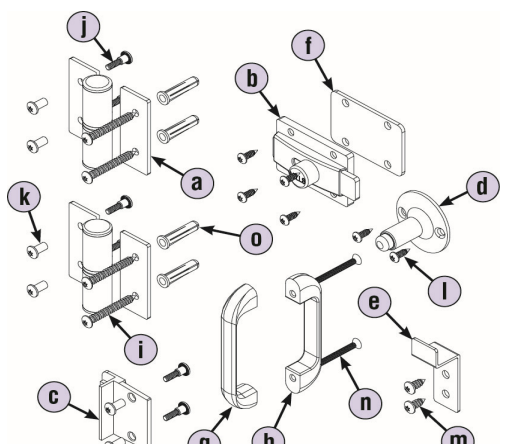
6 Outswing Door Kit with Wall Anchors (right-hand)	HDWC-SD2-RHFH	List Price																																																															
	Includes:	\$ 150.00																																																															
	<table border="1"> <thead> <tr> <th>Part No.</th> <th>Description</th> <th>Qty.</th> </tr> </thead> <tbody> <tr> <td>a</td> <td>HDWC-S0211</td> <td>Surface-Mounted Hinge (LHI/RHO)</td> <td>1</td> </tr> <tr> <td>b</td> <td>HDWL-S160</td> <td>Slide Latch</td> <td>1</td> </tr> <tr> <td>c</td> <td>HDWC-S919</td> <td>Door Stop Inswing</td> <td>1</td> </tr> <tr> <td>d</td> <td>HDWT-S177</td> <td>Wall Bumper</td> <td>1</td> </tr> <tr> <td>e</td> <td>HDWT-S275</td> <td>Coat Hook Outswing</td> <td>1</td> </tr> <tr> <td>f</td> <td>HDWL-P0036</td> <td>Spacer</td> <td>1</td> </tr> <tr> <td>g</td> <td>HDWT-S282</td> <td>Door Pull</td> <td>1</td> </tr> <tr> <td>h</td> <td>HDW0-S0167</td> <td>Door Pull with Countersink SS</td> <td>1</td> </tr> <tr> <td>i</td> <td>FAST-P002</td> <td>Screw #14 x 2" BTN Sheet Metal Torx-T27 w/Pin SS</td> <td>4</td> </tr> <tr> <td>j</td> <td>FAST-P004</td> <td>Screw #10-24 x 3/4" BTN Step-Male Torx-T27</td> <td>6</td> </tr> <tr> <td>k</td> <td>FAST-S0017</td> <td>Screw #10-24 x 1/2" BTN Barrel-Female w/Pin SS</td> <td>6</td> </tr> <tr> <td>l</td> <td>FAST-S0019</td> <td>Screw #10 x 5/8" BTN Sheet Metal Torx-T25 w/Pin SS</td> <td>6</td> </tr> <tr> <td>m</td> <td>FAST-S0016</td> <td>Screw #14 x 5/8" Sheet Metal Torx-T27 SS</td> <td>2</td> </tr> <tr> <td>n</td> <td>FAST-S0027</td> <td>Screw #10-24 x 2" Flat Machine Torx SS</td> <td>2</td> </tr> <tr> <td>o</td> <td>FAST-T373</td> <td>Anchor - Plastic #14-16 x 1 3/8" Lg.</td> <td>4</td> </tr> </tbody> </table>	Part No.	Description	Qty.	a	HDWC-S0211	Surface-Mounted Hinge (LHI/RHO)	1	b	HDWL-S160	Slide Latch	1	c	HDWC-S919	Door Stop Inswing	1	d	HDWT-S177	Wall Bumper	1	e	HDWT-S275	Coat Hook Outswing	1	f	HDWL-P0036	Spacer	1	g	HDWT-S282	Door Pull	1	h	HDW0-S0167	Door Pull with Countersink SS	1	i	FAST-P002	Screw #14 x 2" BTN Sheet Metal Torx-T27 w/Pin SS	4	j	FAST-P004	Screw #10-24 x 3/4" BTN Step-Male Torx-T27	6	k	FAST-S0017	Screw #10-24 x 1/2" BTN Barrel-Female w/Pin SS	6	l	FAST-S0019	Screw #10 x 5/8" BTN Sheet Metal Torx-T25 w/Pin SS	6	m	FAST-S0016	Screw #14 x 5/8" Sheet Metal Torx-T27 SS	2	n	FAST-S0027	Screw #10-24 x 2" Flat Machine Torx SS	2	o	FAST-T373	Anchor - Plastic #14-16 x 1 3/8" Lg.	4	
	Part No.	Description	Qty.																																																														
	a	HDWC-S0211	Surface-Mounted Hinge (LHI/RHO)	1																																																													
	b	HDWL-S160	Slide Latch	1																																																													
	c	HDWC-S919	Door Stop Inswing	1																																																													
	d	HDWT-S177	Wall Bumper	1																																																													
	e	HDWT-S275	Coat Hook Outswing	1																																																													
	f	HDWL-P0036	Spacer	1																																																													
	g	HDWT-S282	Door Pull	1																																																													
	h	HDW0-S0167	Door Pull with Countersink SS	1																																																													
	i	FAST-P002	Screw #14 x 2" BTN Sheet Metal Torx-T27 w/Pin SS	4																																																													
	j	FAST-P004	Screw #10-24 x 3/4" BTN Step-Male Torx-T27	6																																																													
	k	FAST-S0017	Screw #10-24 x 1/2" BTN Barrel-Female w/Pin SS	6																																																													
	l	FAST-S0019	Screw #10 x 5/8" BTN Sheet Metal Torx-T25 w/Pin SS	6																																																													
m	FAST-S0016	Screw #14 x 5/8" Sheet Metal Torx-T27 SS	2																																																														
n	FAST-S0027	Screw #10-24 x 2" Flat Machine Torx SS	2																																																														
o	FAST-T373	Anchor - Plastic #14-16 x 1 3/8" Lg.	4																																																														

NOTE: Torx bits are not included but can be ordered separately.

Effective Date April 1, 2018

Outswing Door Kits

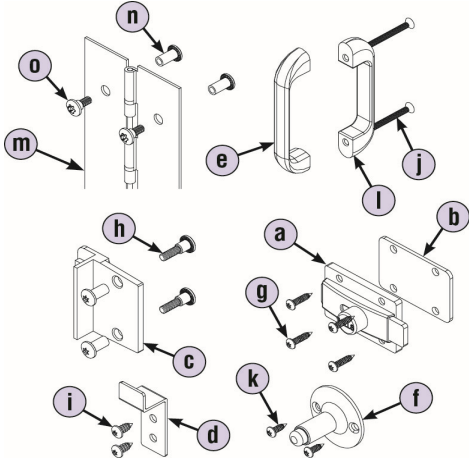
6 Outswing Door Kit w/Piano Hinge (RHI/LHO)	HDWC-S0235	List Price																																																
	Includes:	\$ 198.00																																																
	<table border="1"> <thead> <tr> <th>Part No.</th> <th>Description</th> <th>Qty.</th> </tr> </thead> <tbody> <tr> <td>a</td> <td>HDWL-S160 Slide Latch</td> <td>1</td> </tr> <tr> <td>b</td> <td>HDWL-P0036 Spacer</td> <td>1</td> </tr> <tr> <td>c</td> <td>HDWC-S919 Door Stop</td> <td>1</td> </tr> <tr> <td>d</td> <td>HDWT-S275 Coat Hook Outswing</td> <td>1</td> </tr> <tr> <td>e</td> <td>HDWT-S282 Door Pull</td> <td>1</td> </tr> <tr> <td>f</td> <td>HDWT-S177 Wall Bumper</td> <td>1</td> </tr> <tr> <td>g</td> <td>FAST-S0028 Screw #10-24 x 1" Sheet Metal Torx-T27 SS</td> <td>4</td> </tr> <tr> <td>h</td> <td>FAST-P004 Screw #10-24 x 3/4" BTN Step-Male Torx-T27</td> <td>2</td> </tr> <tr> <td>i</td> <td>FAST-S0016 Screw #14 x 5/8" Sheet Metal Torx-T27 SS</td> <td>2</td> </tr> <tr> <td>j</td> <td>FAST-S0027 Screw #10-24 x 2" Flat Machine Torx SS</td> <td>2</td> </tr> <tr> <td>k</td> <td>FAST-S0019 Screw #10 x 5/8" BTN Sheet Metal Torx-T25 w/Pin SS</td> <td>2</td> </tr> <tr> <td>l</td> <td>HDW0-S0167 Door Pull with Countersink SS</td> <td>1</td> </tr> <tr> <td>m</td> <td>HDWT-S0208 Piano Hinge, Continuous Stainless Steel (RHI/LHO)</td> <td>1</td> </tr> <tr> <td>n</td> <td>FAST-S0017 Screw #10-24 x 1/2" BTN Barrel-Female w/Pin SS</td> <td>14</td> </tr> <tr> <td>o</td> <td>FAST-S0018 Screw #10-24 x 1/2" Shoulder Torx-T27 SS</td> <td>12</td> </tr> </tbody> </table>	Part No.	Description	Qty.	a	HDWL-S160 Slide Latch	1	b	HDWL-P0036 Spacer	1	c	HDWC-S919 Door Stop	1	d	HDWT-S275 Coat Hook Outswing	1	e	HDWT-S282 Door Pull	1	f	HDWT-S177 Wall Bumper	1	g	FAST-S0028 Screw #10-24 x 1" Sheet Metal Torx-T27 SS	4	h	FAST-P004 Screw #10-24 x 3/4" BTN Step-Male Torx-T27	2	i	FAST-S0016 Screw #14 x 5/8" Sheet Metal Torx-T27 SS	2	j	FAST-S0027 Screw #10-24 x 2" Flat Machine Torx SS	2	k	FAST-S0019 Screw #10 x 5/8" BTN Sheet Metal Torx-T25 w/Pin SS	2	l	HDW0-S0167 Door Pull with Countersink SS	1	m	HDWT-S0208 Piano Hinge, Continuous Stainless Steel (RHI/LHO)	1	n	FAST-S0017 Screw #10-24 x 1/2" BTN Barrel-Female w/Pin SS	14	o	FAST-S0018 Screw #10-24 x 1/2" Shoulder Torx-T27 SS	12	
	Part No.	Description	Qty.																																															
	a	HDWL-S160 Slide Latch	1																																															
	b	HDWL-P0036 Spacer	1																																															
	c	HDWC-S919 Door Stop	1																																															
	d	HDWT-S275 Coat Hook Outswing	1																																															
	e	HDWT-S282 Door Pull	1																																															
	f	HDWT-S177 Wall Bumper	1																																															
	g	FAST-S0028 Screw #10-24 x 1" Sheet Metal Torx-T27 SS	4																																															
	h	FAST-P004 Screw #10-24 x 3/4" BTN Step-Male Torx-T27	2																																															
	i	FAST-S0016 Screw #14 x 5/8" Sheet Metal Torx-T27 SS	2																																															
	j	FAST-S0027 Screw #10-24 x 2" Flat Machine Torx SS	2																																															
	k	FAST-S0019 Screw #10 x 5/8" BTN Sheet Metal Torx-T25 w/Pin SS	2																																															
l	HDW0-S0167 Door Pull with Countersink SS	1																																																
m	HDWT-S0208 Piano Hinge, Continuous Stainless Steel (RHI/LHO)	1																																																
n	FAST-S0017 Screw #10-24 x 1/2" BTN Barrel-Female w/Pin SS	14																																																
o	FAST-S0018 Screw #10-24 x 1/2" Shoulder Torx-T27 SS	12																																																

NOTE: Torx bits are not included but can be ordered separately.

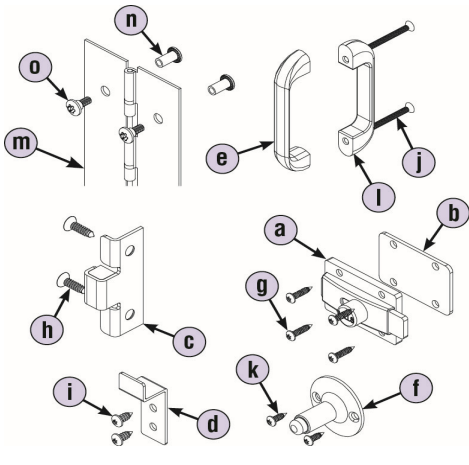
6 Outswing Flat Strike Door Kit w/Piano Hinge (RHI/LHO)	HDWC-S0239	List Price																																																
	Includes:	\$ 198.00																																																
	<table border="1"> <thead> <tr> <th>Part No.</th> <th>Description</th> <th>Qty.</th> </tr> </thead> <tbody> <tr> <td>a</td> <td>HDWL-S160 Slide Latch</td> <td>1</td> </tr> <tr> <td>b</td> <td>HDWL-P0036 Spacer</td> <td>1</td> </tr> <tr> <td>c</td> <td>HDWC-S0022 Flat Door Stop/Keeper</td> <td>1</td> </tr> <tr> <td>d</td> <td>HDWT-S275 Coat Hook Outswing</td> <td>1</td> </tr> <tr> <td>e</td> <td>HDWT-S282 Door Pull</td> <td>1</td> </tr> <tr> <td>f</td> <td>HDWT-S177 Wall Bumper</td> <td>1</td> </tr> <tr> <td>g</td> <td>FAST-S0028 Screw #10-24 x 1" Sheet Metal Torx-T27 SS</td> <td>4</td> </tr> <tr> <td>h</td> <td>FAST-S0006 Screw #10 x 3/4" FL Sheet Metal Torx-T25</td> <td>2</td> </tr> <tr> <td>i</td> <td>FAST-S0016 Screw #14 x 5/8" Sheet Metal Torx-T27 SS</td> <td>2</td> </tr> <tr> <td>j</td> <td>FAST-S0027 Screw #10-24 x 2" Flat Machine Torx SS</td> <td>2</td> </tr> <tr> <td>k</td> <td>FAST-S0019 Screw #10 x 5/8" BTN Sheet Metal Torx-T25 w/Pin SS</td> <td>2</td> </tr> <tr> <td>l</td> <td>HDW0-S0167 Door Pull with Countersink SS</td> <td>1</td> </tr> <tr> <td>m</td> <td>HDWT-S0208 Piano Hinge, Continuous Stainless Steel (RHI/LHO)</td> <td>1</td> </tr> <tr> <td>n</td> <td>FAST-S0017 Screw #10-24 x 1/2" BTN Barrel-Female w/Pin SS</td> <td>12</td> </tr> <tr> <td>o</td> <td>FAST-S0018 Screw #10-24 x 1/2" Shoulder Torx-T27 SS</td> <td>12</td> </tr> </tbody> </table>	Part No.	Description	Qty.	a	HDWL-S160 Slide Latch	1	b	HDWL-P0036 Spacer	1	c	HDWC-S0022 Flat Door Stop/Keeper	1	d	HDWT-S275 Coat Hook Outswing	1	e	HDWT-S282 Door Pull	1	f	HDWT-S177 Wall Bumper	1	g	FAST-S0028 Screw #10-24 x 1" Sheet Metal Torx-T27 SS	4	h	FAST-S0006 Screw #10 x 3/4" FL Sheet Metal Torx-T25	2	i	FAST-S0016 Screw #14 x 5/8" Sheet Metal Torx-T27 SS	2	j	FAST-S0027 Screw #10-24 x 2" Flat Machine Torx SS	2	k	FAST-S0019 Screw #10 x 5/8" BTN Sheet Metal Torx-T25 w/Pin SS	2	l	HDW0-S0167 Door Pull with Countersink SS	1	m	HDWT-S0208 Piano Hinge, Continuous Stainless Steel (RHI/LHO)	1	n	FAST-S0017 Screw #10-24 x 1/2" BTN Barrel-Female w/Pin SS	12	o	FAST-S0018 Screw #10-24 x 1/2" Shoulder Torx-T27 SS	12	
	Part No.	Description	Qty.																																															
	a	HDWL-S160 Slide Latch	1																																															
	b	HDWL-P0036 Spacer	1																																															
	c	HDWC-S0022 Flat Door Stop/Keeper	1																																															
	d	HDWT-S275 Coat Hook Outswing	1																																															
	e	HDWT-S282 Door Pull	1																																															
	f	HDWT-S177 Wall Bumper	1																																															
	g	FAST-S0028 Screw #10-24 x 1" Sheet Metal Torx-T27 SS	4																																															
	h	FAST-S0006 Screw #10 x 3/4" FL Sheet Metal Torx-T25	2																																															
	i	FAST-S0016 Screw #14 x 5/8" Sheet Metal Torx-T27 SS	2																																															
	j	FAST-S0027 Screw #10-24 x 2" Flat Machine Torx SS	2																																															
	k	FAST-S0019 Screw #10 x 5/8" BTN Sheet Metal Torx-T25 w/Pin SS	2																																															
l	HDW0-S0167 Door Pull with Countersink SS	1																																																
m	HDWT-S0208 Piano Hinge, Continuous Stainless Steel (RHI/LHO)	1																																																
n	FAST-S0017 Screw #10-24 x 1/2" BTN Barrel-Female w/Pin SS	12																																																
o	FAST-S0018 Screw #10-24 x 1/2" Shoulder Torx-T27 SS	12																																																

NOTE: Torx bits are not included but can be ordered separately.

Effective Date April 1, 2018

Outswing Door Kits

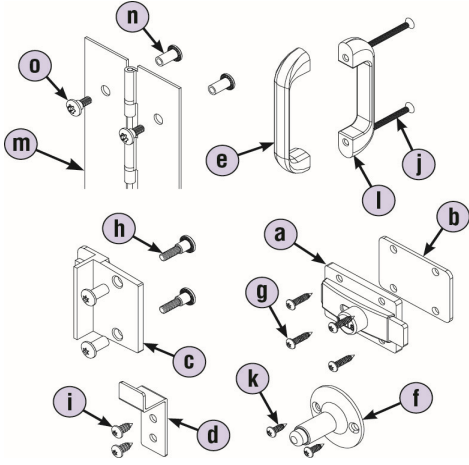
6 Outswing Door Kit w/Piano Hinge (LHI/RHO)	HDWC-S0237	List Price																																																
	Includes:	\$ 198.00																																																
	<table border="1"> <thead> <tr> <th>Part No.</th> <th>Description</th> <th>Qty.</th> </tr> </thead> <tbody> <tr> <td>a</td> <td>HDWL-S160 Slide Latch</td> <td>1</td> </tr> <tr> <td>b</td> <td>HDWL-P0036 Spacer</td> <td>1</td> </tr> <tr> <td>c</td> <td>HDWC-S919 Door Stop</td> <td>1</td> </tr> <tr> <td>d</td> <td>HDWT-S275 Coat Hook Outswing</td> <td>1</td> </tr> <tr> <td>e</td> <td>HDWT-S282 Door Pull</td> <td>1</td> </tr> <tr> <td>f</td> <td>HDWT-S177 Wall Bumper</td> <td>1</td> </tr> <tr> <td>g</td> <td>FAST-S0028 Screw #10-24 x 1" Sheet Metal Torx-T27 SS</td> <td>4</td> </tr> <tr> <td>h</td> <td>FAST-P004 Screw #10-24 x 3/4" BTN Step-Male Torx-T27</td> <td>2</td> </tr> <tr> <td>i</td> <td>FAST-S0016 Screw #14 x 5/8" Sheet Metal Torx-T27 SS</td> <td>2</td> </tr> <tr> <td>j</td> <td>FAST-S0027 Screw #10-24 x 2" Flat Machine Torx SS</td> <td>2</td> </tr> <tr> <td>k</td> <td>FAST-S0019 Screw #10 x 5/8" BTN Sheet Metal Torx-T25 w/Pin SS</td> <td>2</td> </tr> <tr> <td>l</td> <td>HDW0-S0167 Door Pull with Countersink SS</td> <td>1</td> </tr> <tr> <td>m</td> <td>HDWT-S0209 Piano Hinge, Continuous Stainless Steel (LHI/RHO)</td> <td>1</td> </tr> <tr> <td>n</td> <td>FAST-S0017 Screw #10-24 x 1/2" BTN Barrel-Female w/Pin SS</td> <td>14</td> </tr> <tr> <td>o</td> <td>FAST-S0018 Screw #10-24 x 1/2" Shoulder Torx-T27 SS</td> <td>12</td> </tr> </tbody> </table>	Part No.	Description	Qty.	a	HDWL-S160 Slide Latch	1	b	HDWL-P0036 Spacer	1	c	HDWC-S919 Door Stop	1	d	HDWT-S275 Coat Hook Outswing	1	e	HDWT-S282 Door Pull	1	f	HDWT-S177 Wall Bumper	1	g	FAST-S0028 Screw #10-24 x 1" Sheet Metal Torx-T27 SS	4	h	FAST-P004 Screw #10-24 x 3/4" BTN Step-Male Torx-T27	2	i	FAST-S0016 Screw #14 x 5/8" Sheet Metal Torx-T27 SS	2	j	FAST-S0027 Screw #10-24 x 2" Flat Machine Torx SS	2	k	FAST-S0019 Screw #10 x 5/8" BTN Sheet Metal Torx-T25 w/Pin SS	2	l	HDW0-S0167 Door Pull with Countersink SS	1	m	HDWT-S0209 Piano Hinge, Continuous Stainless Steel (LHI/RHO)	1	n	FAST-S0017 Screw #10-24 x 1/2" BTN Barrel-Female w/Pin SS	14	o	FAST-S0018 Screw #10-24 x 1/2" Shoulder Torx-T27 SS	12	
	Part No.	Description	Qty.																																															
	a	HDWL-S160 Slide Latch	1																																															
	b	HDWL-P0036 Spacer	1																																															
	c	HDWC-S919 Door Stop	1																																															
	d	HDWT-S275 Coat Hook Outswing	1																																															
	e	HDWT-S282 Door Pull	1																																															
	f	HDWT-S177 Wall Bumper	1																																															
	g	FAST-S0028 Screw #10-24 x 1" Sheet Metal Torx-T27 SS	4																																															
	h	FAST-P004 Screw #10-24 x 3/4" BTN Step-Male Torx-T27	2																																															
	i	FAST-S0016 Screw #14 x 5/8" Sheet Metal Torx-T27 SS	2																																															
	j	FAST-S0027 Screw #10-24 x 2" Flat Machine Torx SS	2																																															
	k	FAST-S0019 Screw #10 x 5/8" BTN Sheet Metal Torx-T25 w/Pin SS	2																																															
	l	HDW0-S0167 Door Pull with Countersink SS	1																																															
m	HDWT-S0209 Piano Hinge, Continuous Stainless Steel (LHI/RHO)	1																																																
n	FAST-S0017 Screw #10-24 x 1/2" BTN Barrel-Female w/Pin SS	14																																																
o	FAST-S0018 Screw #10-24 x 1/2" Shoulder Torx-T27 SS	12																																																

NOTE: Torx bits are not included but can be ordered separately.

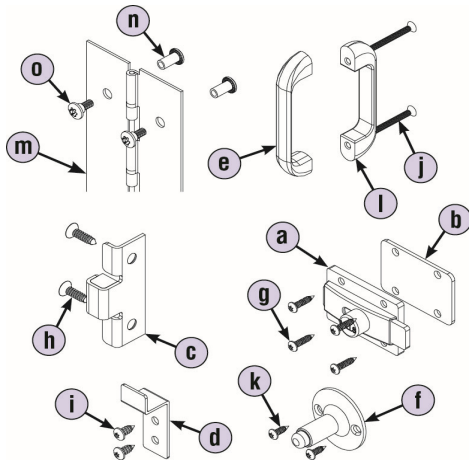
6 Outswing Flat Strike Door Kit w/Piano Hinge (LHI/RHO)	HDWC-S0241	List Price																																																
	Includes:	\$ 198.00																																																
	<table border="1"> <thead> <tr> <th>Part No.</th> <th>Description</th> <th>Qty.</th> </tr> </thead> <tbody> <tr> <td>a</td> <td>HDWL-S160 Slide Latch</td> <td>1</td> </tr> <tr> <td>b</td> <td>HDWL-P0036 Spacer</td> <td>1</td> </tr> <tr> <td>c</td> <td>HDWC-S0022 Flat Door Stop/Keeper</td> <td>1</td> </tr> <tr> <td>d</td> <td>HDWT-S275 Coat Hook Outswing</td> <td>1</td> </tr> <tr> <td>e</td> <td>HDWT-S282 Door Pull</td> <td>1</td> </tr> <tr> <td>f</td> <td>HDWT-S177 Wall Bumper</td> <td>1</td> </tr> <tr> <td>g</td> <td>FAST-S0028 Screw #10-24 x 1" Sheet Metal Torx-T27 SS</td> <td>4</td> </tr> <tr> <td>h</td> <td>FAST-S0006 Screw #10 x 3/4" FL Sheet Metal Torx-T25</td> <td>2</td> </tr> <tr> <td>i</td> <td>FAST-S0016 Screw #14 x 5/8" Sheet Metal Torx-T27 SS</td> <td>2</td> </tr> <tr> <td>j</td> <td>FAST-S0027 Screw #10-24 x 2" Flat Machine Torx SS</td> <td>2</td> </tr> <tr> <td>k</td> <td>FAST-S0019 Screw #10 x 5/8" BTN Sheet Metal Torx-T25 w/Pin SS</td> <td>2</td> </tr> <tr> <td>l</td> <td>HDW0-S0167 Door Pull with Countersink SS</td> <td>1</td> </tr> <tr> <td>m</td> <td>HDWT-S0209 Piano Hinge, Continuous Stainless Steel (LHI/RHO)</td> <td>1</td> </tr> <tr> <td>n</td> <td>FAST-S0017 Screw #10-24 x 1/2" BTN Barrel-Female w/Pin SS</td> <td>12</td> </tr> <tr> <td>o</td> <td>FAST-S0018 Screw #10-24 x 1/2" Shoulder Torx-T27 SS</td> <td>12</td> </tr> </tbody> </table>	Part No.	Description	Qty.	a	HDWL-S160 Slide Latch	1	b	HDWL-P0036 Spacer	1	c	HDWC-S0022 Flat Door Stop/Keeper	1	d	HDWT-S275 Coat Hook Outswing	1	e	HDWT-S282 Door Pull	1	f	HDWT-S177 Wall Bumper	1	g	FAST-S0028 Screw #10-24 x 1" Sheet Metal Torx-T27 SS	4	h	FAST-S0006 Screw #10 x 3/4" FL Sheet Metal Torx-T25	2	i	FAST-S0016 Screw #14 x 5/8" Sheet Metal Torx-T27 SS	2	j	FAST-S0027 Screw #10-24 x 2" Flat Machine Torx SS	2	k	FAST-S0019 Screw #10 x 5/8" BTN Sheet Metal Torx-T25 w/Pin SS	2	l	HDW0-S0167 Door Pull with Countersink SS	1	m	HDWT-S0209 Piano Hinge, Continuous Stainless Steel (LHI/RHO)	1	n	FAST-S0017 Screw #10-24 x 1/2" BTN Barrel-Female w/Pin SS	12	o	FAST-S0018 Screw #10-24 x 1/2" Shoulder Torx-T27 SS	12	
	Part No.	Description	Qty.																																															
	a	HDWL-S160 Slide Latch	1																																															
	b	HDWL-P0036 Spacer	1																																															
	c	HDWC-S0022 Flat Door Stop/Keeper	1																																															
	d	HDWT-S275 Coat Hook Outswing	1																																															
	e	HDWT-S282 Door Pull	1																																															
	f	HDWT-S177 Wall Bumper	1																																															
	g	FAST-S0028 Screw #10-24 x 1" Sheet Metal Torx-T27 SS	4																																															
	h	FAST-S0006 Screw #10 x 3/4" FL Sheet Metal Torx-T25	2																																															
	i	FAST-S0016 Screw #14 x 5/8" Sheet Metal Torx-T27 SS	2																																															
	j	FAST-S0027 Screw #10-24 x 2" Flat Machine Torx SS	2																																															
	k	FAST-S0019 Screw #10 x 5/8" BTN Sheet Metal Torx-T25 w/Pin SS	2																																															
	l	HDW0-S0167 Door Pull with Countersink SS	1																																															
m	HDWT-S0209 Piano Hinge, Continuous Stainless Steel (LHI/RHO)	1																																																
n	FAST-S0017 Screw #10-24 x 1/2" BTN Barrel-Female w/Pin SS	12																																																
o	FAST-S0018 Screw #10-24 x 1/2" Shoulder Torx-T27 SS	12																																																

NOTE: Torx bits are not included but can be ordered separately.

Effective Date April 1, 2018

Pilaster-Panel Kits

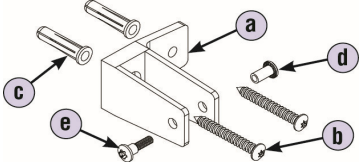
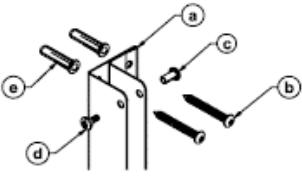
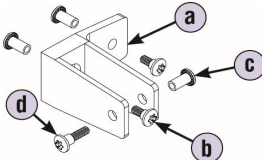
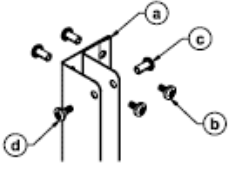
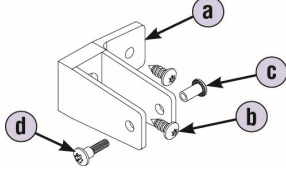
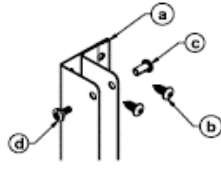
7 Pilaster at Wall "F" Bracket	HDWC-S3FF	List Price																		
	Includes: <table border="1"> <thead> <tr> <th>Part No.</th> <th>Description</th> <th>Qty.</th> </tr> </thead> <tbody> <tr> <td>a</td> <td>HDWC-S337 Bracket, Stirrup, Single-Ear</td> <td>2</td> </tr> <tr> <td>b</td> <td>FAST-P002 Screw #14 x 2" BTN Sheet Metal Torx-T27 w/Pin SS</td> <td>4</td> </tr> <tr> <td>c</td> <td>FAST-T373 Anchor - Plastic #14-16 x 1 3/8" Lg.</td> <td>4</td> </tr> <tr> <td>d</td> <td>FAST-S0017 Screw #10-24 x 1/2" BTN Barrel-Female w/Pin SS</td> <td>2</td> </tr> <tr> <td>e</td> <td>FAST-P004 Screw #10-24 x 3/4" BTN Step-Male Torx-T27</td> <td>2</td> </tr> </tbody> </table> <p>NOTE: Torx bits are not included but can be ordered separately.</p>	Part No.	Description	Qty.	a	HDWC-S337 Bracket, Stirrup, Single-Ear	2	b	FAST-P002 Screw #14 x 2" BTN Sheet Metal Torx-T27 w/Pin SS	4	c	FAST-T373 Anchor - Plastic #14-16 x 1 3/8" Lg.	4	d	FAST-S0017 Screw #10-24 x 1/2" BTN Barrel-Female w/Pin SS	2	e	FAST-P004 Screw #10-24 x 3/4" BTN Step-Male Torx-T27	2	\$ 36.00
Part No.	Description	Qty.																		
a	HDWC-S337 Bracket, Stirrup, Single-Ear	2																		
b	FAST-P002 Screw #14 x 2" BTN Sheet Metal Torx-T27 w/Pin SS	4																		
c	FAST-T373 Anchor - Plastic #14-16 x 1 3/8" Lg.	4																		
d	FAST-S0017 Screw #10-24 x 1/2" BTN Barrel-Female w/Pin SS	2																		
e	FAST-P004 Screw #10-24 x 3/4" BTN Step-Male Torx-T27	2																		
7 Pilaster at Wall "F" Bracket (Stn. Steel Continuous)	HDWC-S0480-57	List Price																		
	Includes: <table border="1"> <thead> <tr> <th>Part No.</th> <th>Description</th> <th>Qty.</th> </tr> </thead> <tbody> <tr> <td>a</td> <td>HDWC-S184-57 Bracket, 1-Ear, 3/4" x 57"</td> <td>1</td> </tr> <tr> <td>b</td> <td>FAST-P002 Screw #14 x 2" BTN Sheet Metal Torx-T27 w/Pin SS</td> <td>10</td> </tr> <tr> <td>c</td> <td>FAST-S0017 Screw #10-24 x 1/2" BTN Barrel-Female w/Pin SS</td> <td>5</td> </tr> <tr> <td>d</td> <td>FAST-S0018 Screw #10-24 x 1/2" Shoulder Torx-T27 SS</td> <td>5</td> </tr> <tr> <td>e</td> <td>FAST-T373 Anchor - Plastic #14-16 x 1 3/8" Lg.</td> <td>10</td> </tr> </tbody> </table> <p>Also available in Aluminum - HDWC-A0040</p> <p>NOTE: Torx bits are not included but can be ordered separately.</p>	Part No.	Description	Qty.	a	HDWC-S184-57 Bracket, 1-Ear, 3/4" x 57"	1	b	FAST-P002 Screw #14 x 2" BTN Sheet Metal Torx-T27 w/Pin SS	10	c	FAST-S0017 Screw #10-24 x 1/2" BTN Barrel-Female w/Pin SS	5	d	FAST-S0018 Screw #10-24 x 1/2" Shoulder Torx-T27 SS	5	e	FAST-T373 Anchor - Plastic #14-16 x 1 3/8" Lg.	10	\$ 121.00 \$ 60.00
Part No.	Description	Qty.																		
a	HDWC-S184-57 Bracket, 1-Ear, 3/4" x 57"	1																		
b	FAST-P002 Screw #14 x 2" BTN Sheet Metal Torx-T27 w/Pin SS	10																		
c	FAST-S0017 Screw #10-24 x 1/2" BTN Barrel-Female w/Pin SS	5																		
d	FAST-S0018 Screw #10-24 x 1/2" Shoulder Torx-T27 SS	5																		
e	FAST-T373 Anchor - Plastic #14-16 x 1 3/8" Lg.	10																		
Pilaster at Panel "F" Bracket	HDWC-S0015	List Price																		
	Includes: <table border="1"> <thead> <tr> <th>Part No.</th> <th>Description</th> <th>Qty.</th> </tr> </thead> <tbody> <tr> <td>a</td> <td>HDWC-S337 Bracket, Stirrup, Single-Ear</td> <td>2</td> </tr> <tr> <td>b</td> <td>FAST-S0018 Screw #10-24 x 1/2" Shoulder Torx-T27 SS</td> <td>4</td> </tr> <tr> <td>c</td> <td>FAST-S0017 Screw #10-24 x 1/2" BTN Barrel-Female w/Pin SS</td> <td>6</td> </tr> <tr> <td>d</td> <td>FAST-P004 Screw #10-24 x 3/4" BTN Step-Male Torx-T27</td> <td>2</td> </tr> </tbody> </table> <p>NOTE: Torx bits are not included but can be ordered separately.</p>	Part No.	Description	Qty.	a	HDWC-S337 Bracket, Stirrup, Single-Ear	2	b	FAST-S0018 Screw #10-24 x 1/2" Shoulder Torx-T27 SS	4	c	FAST-S0017 Screw #10-24 x 1/2" BTN Barrel-Female w/Pin SS	6	d	FAST-P004 Screw #10-24 x 3/4" BTN Step-Male Torx-T27	2	\$ 36.00			
Part No.	Description	Qty.																		
a	HDWC-S337 Bracket, Stirrup, Single-Ear	2																		
b	FAST-S0018 Screw #10-24 x 1/2" Shoulder Torx-T27 SS	4																		
c	FAST-S0017 Screw #10-24 x 1/2" BTN Barrel-Female w/Pin SS	6																		
d	FAST-P004 Screw #10-24 x 3/4" BTN Step-Male Torx-T27	2																		
Pilaster at Panel "F" Bracket (Stn. Steel Continuous)	HDWC-S0481A-57	List Price																		
	Includes: <table border="1"> <thead> <tr> <th>Part No.</th> <th>Description</th> <th>Qty.</th> </tr> </thead> <tbody> <tr> <td>a</td> <td>HDWC-S184-57 Bracket, Continuous, Single-Ear</td> <td>1</td> </tr> <tr> <td>b</td> <td>FAST-S0015 Screw #10-24 x 3/8" Machine Torx-T27 SS</td> <td>10</td> </tr> <tr> <td>c</td> <td>FAST-S0017 Screw #10-24 x 1/2" BTN Barrel-Female w/Pin SS</td> <td>15</td> </tr> <tr> <td>d</td> <td>FAST-S0018 Screw #10-24 x 1/2" Shoulder Torx-T27 SS</td> <td>5</td> </tr> </tbody> </table> <p>Also available in Aluminum - HDWC-A0166</p> <p>NOTE: Torx bits are not included but can be ordered separately.</p>	Part No.	Description	Qty.	a	HDWC-S184-57 Bracket, Continuous, Single-Ear	1	b	FAST-S0015 Screw #10-24 x 3/8" Machine Torx-T27 SS	10	c	FAST-S0017 Screw #10-24 x 1/2" BTN Barrel-Female w/Pin SS	15	d	FAST-S0018 Screw #10-24 x 1/2" Shoulder Torx-T27 SS	5	\$ 102.00 \$ 57.00			
Part No.	Description	Qty.																		
a	HDWC-S184-57 Bracket, Continuous, Single-Ear	1																		
b	FAST-S0015 Screw #10-24 x 3/8" Machine Torx-T27 SS	10																		
c	FAST-S0017 Screw #10-24 x 1/2" BTN Barrel-Female w/Pin SS	15																		
d	FAST-S0018 Screw #10-24 x 1/2" Shoulder Torx-T27 SS	5																		
Pilaster at Pilaster "F" Bracket	HDWC-S0016	List Price																		
	Includes: <table border="1"> <thead> <tr> <th>Part No.</th> <th>Description</th> <th>Qty.</th> </tr> </thead> <tbody> <tr> <td>a</td> <td>HDWC-S337 Bracket, Stirrup, Single-Ear</td> <td>2</td> </tr> <tr> <td>b</td> <td>FAST-S0016 Screw #14 x 5/8" Sheet Metal Torx-T27 SS</td> <td>4</td> </tr> <tr> <td>c</td> <td>FAST-S0017 Screw #10-24 x 1/2" BTN Barrel-Female w/Pin SS</td> <td>2</td> </tr> <tr> <td>d</td> <td>FAST-P004 Screw #10-24 x 3/4" BTN Step-Male Torx-T27</td> <td>2</td> </tr> </tbody> </table> <p>NOTE: Torx bits are not included but can be ordered separately.</p>	Part No.	Description	Qty.	a	HDWC-S337 Bracket, Stirrup, Single-Ear	2	b	FAST-S0016 Screw #14 x 5/8" Sheet Metal Torx-T27 SS	4	c	FAST-S0017 Screw #10-24 x 1/2" BTN Barrel-Female w/Pin SS	2	d	FAST-P004 Screw #10-24 x 3/4" BTN Step-Male Torx-T27	2	\$ 23.00			
Part No.	Description	Qty.																		
a	HDWC-S337 Bracket, Stirrup, Single-Ear	2																		
b	FAST-S0016 Screw #14 x 5/8" Sheet Metal Torx-T27 SS	4																		
c	FAST-S0017 Screw #10-24 x 1/2" BTN Barrel-Female w/Pin SS	2																		
d	FAST-P004 Screw #10-24 x 3/4" BTN Step-Male Torx-T27	2																		
Pilaster at Pilaster "F" Bracket (Stn. Steel Continuous)	HDWC-S0481-57	List Price																		
	Includes: <table border="1"> <thead> <tr> <th>Part No.</th> <th>Description</th> <th>Qty.</th> </tr> </thead> <tbody> <tr> <td>a</td> <td>HDWC-S184-57 Bracket, Continuous, Single-Ear</td> <td>1</td> </tr> <tr> <td>b</td> <td>FAST-S0016 Screw #14 x 5/8" Sheet Metal Torx-T27 SS</td> <td>10</td> </tr> <tr> <td>c</td> <td>FAST-S0017 Screw #10-24 x 1/2" BTN Barrel-Female w/Pin SS</td> <td>5</td> </tr> <tr> <td>d</td> <td>FAST-S0018 Screw #10-24 x 1/2" Shoulder Torx-T27 SS</td> <td>5</td> </tr> </tbody> </table> <p>Also available in Aluminum - HDWC-A0041</p> <p>NOTE: Torx bits are not included but can be ordered separately.</p>	Part No.	Description	Qty.	a	HDWC-S184-57 Bracket, Continuous, Single-Ear	1	b	FAST-S0016 Screw #14 x 5/8" Sheet Metal Torx-T27 SS	10	c	FAST-S0017 Screw #10-24 x 1/2" BTN Barrel-Female w/Pin SS	5	d	FAST-S0018 Screw #10-24 x 1/2" Shoulder Torx-T27 SS	5	\$ 89.00 \$ 54.00			
Part No.	Description	Qty.																		
a	HDWC-S184-57 Bracket, Continuous, Single-Ear	1																		
b	FAST-S0016 Screw #14 x 5/8" Sheet Metal Torx-T27 SS	10																		
c	FAST-S0017 Screw #10-24 x 1/2" BTN Barrel-Female w/Pin SS	5																		
d	FAST-S0018 Screw #10-24 x 1/2" Shoulder Torx-T27 SS	5																		

Prices subject to change without notice.
Items may be changed or discontinued
without notice and without incurring obligation.

Effective Date April 1, 2018

Dividing Panel and End Panel Kits

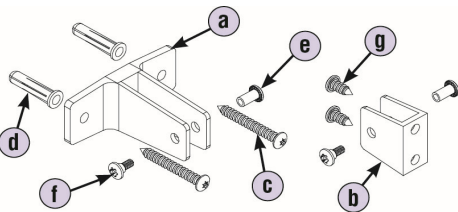
8 Dividing Panel Kit 	HDWC-S1PD		List Price
	Includes:		\$ 40.00
	Part No.	Description	Qty.
a	HDWC-S334	Bracket, Double-Ear Wall	2
b	HDWC-S336	Bracket, Stirrup, "U"	2
c	FAST-P002	Screw #14 x 2" BTN Sheet Metal Torx-T27 w/Pin SS	4
d	FAST-T373	Anchor - Plastic #14-16 x 1 3/8" Lg.	4
e	FAST-S0017	Screw #10-24 x 1/2" BTN Barrel-Female w/Pin SS	4
f	FAST-S0018	Screw #10-24 x 1/2" Shoulder Torx-T27 SS	4
g	FAST-S0016	Screw #14 x 3/8" Sheet Metal Torx-T27 SS	4

NOTE: Torx bits are not included but can be ordered separately.

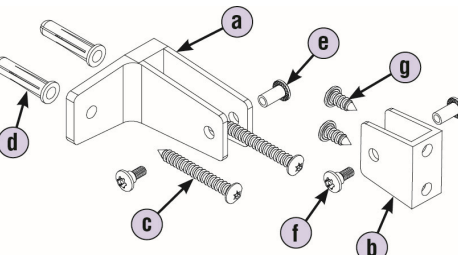
9 Ending Panel Kit 	HDWC-S2PE		List Price
	Includes:		\$ 38.00
	Part No.	Description	Qty.
a	HDWC-S332	Bracket, Stirrup, Single-Ear	2
b	HDWC-S336	Bracket, Stirrup, "U"	2
c	FAST-P002	Screw #14 x 2" BTN Sheet Metal Torx-T27 w/Pin SS	4
d	FAST-T373	Anchor - Plastic #14-16 x 1 3/8" Lg.	4
e	FAST-S0017	Screw #10-24 x 1/2" BTN Barrel-Female w/Pin SS	4
f	FAST-S0018	Screw #10-24 x 1/2" Shoulder Torx-T27 SS	4
g	FAST-S0016	Screw #14 x 3/8" Sheet Metal Torx-T27 SS	4

NOTE: Torx bits are not included but can be ordered separately.

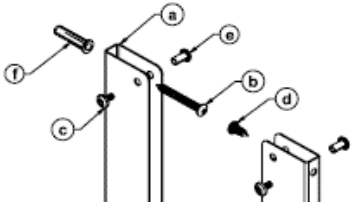
9 Dividing/Ending Panel Kit (Stainless Steel Continuous) 	HDWC-S0475-57		List Price
	Includes:		\$ 153.00
	Part No.	Description	Qty.
a	C190-02-57	Bracket, "U" Continuous, 2" x 57"	2
b	FAST-P002	Screw #14 x 2" BTN Sheet Metal Torx-T27 w/Pin SS	5
c	FAST-S0015	Screw #10-24 x 3/8" Machine Torx-T27 SS	10
d	FAST-S0016	Screw #14 x 3/8" Sheet Metal Torx-T27 SS	5
e	FAST-S0017	Screw #10-24 x 1/2" BTN Barrel-Female w/Pin SS	10
f	FAST-T373	Anchor - Plastic #14-16 x 1 3/8" Lg.	5

NOTE: Torx bits are not included but can be ordered separately.

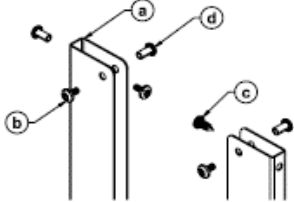
9 Dividing/Ending Panel @ Pilaster Kit (Stainless Continuous) 	HDWC-S0476-57		List Price
	Includes:		\$ 153.00
	Part No.	Description	Qty.
a	C190-02-57	Bracket, "U" Continuous, 2" x 57"	2
b	FAST-S0015	Screw #10-24 x 3/8" Machine Torx-T27 SS	15
c	FAST-S0016	Screw #14 x 3/8" Sheet Metal Torx-T27 SS	5
d	FAST-S0017	Screw #10-24 x 1/2" BTN Barrel-Female w/Pin SS	15

NOTE: Torx bits are not included but can be ordered separately.

Effective Date April 1, 2018

Additional Kits

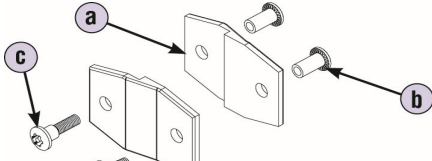
Alcove Kit 	HDWC-S4AL			List Price
	Includes:			\$ 41.00
	Part No.	Description	Qty.	
a	HDWT-S341	Bracket, Alcove	4	
b	FAST-S0017	Screw #10-24 x 1/2" BTN Barrel-Female w/Pin SS	4	
c	FAST-P004	Screw #10-24 x 3/4" BTN Step-Male Torx-T27	2	
d	FAST-S0018	Screw #10-24 x 1/2" Shoulder Torx-T27 SS	2	

NOTE: Torx bits are not included but can be ordered separately.

Alcove Kit (Continuous) 	HDWC-S0479-57			List Price
	Includes:			\$ 156.00
	Part No.	Description	Qty.	
a	HDWT-S0290-57	Bracket, Continuous Alcove Offset	4	
b	FAST-S0015	Screw #10-24 x 3/8" Machine Torx-T27 SS	10	
c	FAST-S0017	Screw #10-24 x 1/2" BTN Barrel-Female w/Pin SS	20	
d	FAST-S0018	Screw #10-24 x 1/2" Shoulder Torx-T27 SS	10	

NOTE: Torx bits are not included but can be ordered separately.

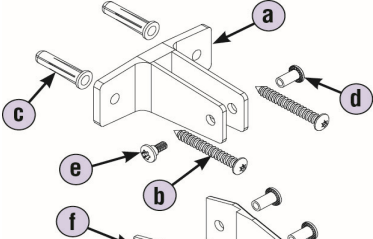
Dividing Alcove Panel Kit (Stainless Steel Stirrup) 	HDWC-S0286			List Price
	Includes:			\$ 95.00
	Part No.	Description	Qty.	
a	HDWC-S334	Bracket, Double-Ear Wall	2	
b	FAST-P002	Screw #14 x 2" BTN Sheet Metal Torx-T27 w/Pin SS	4	
c	FAST-T373	Anchor - Plastic #14-16 x 1 3/8" Lg.	4	
d	FAST-S0017	Screw #10-24 x 1/2" BTN Barrel-Female w/Pin SS	6	
e	FAST-S0018	Screw #10-24 x 1/2" Shoulder Torx-T27 SS	4	
f	HDWT-S341	Bracket, Alcove	4	
g	FAST-P004	Screw #10-24 x 3/4" BTN Step-Male Torx-T27	2	

NOTE: Torx bits are not included but can be ordered separately.

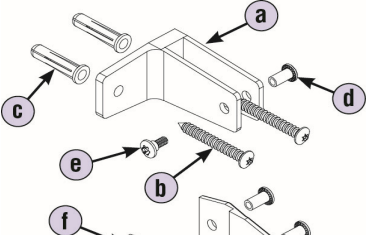
Ending Alcove Panel Kit (Stainless Steel Stirrup) 	HDWC-S0287			List Price
	Includes:			\$ 95.00
	Part No.	Description	Qty.	
a	HDWC-S332	Bracket, Stirrup, Single-Ear	2	
b	FAST-P002	Screw #14 x 2" BTN Sheet Metal Torx-T27 w/Pin SS	4	
c	FAST-T373	Anchor - Plastic #14-16 x 1 3/8" Lg.	4	
d	FAST-S0017	Screw #10-24 x 1/2" BTN Barrel-Female w/Pin SS	6	
e	FAST-S0018	Screw #10-24 x 1/2" Shoulder Torx-T27 SS	4	
f	HDWT-S341	Bracket, Alcove	4	
g	FAST-P004	Screw #10-24 x 3/4" BTN Step-Male Torx-T27	2	

NOTE: Torx bits are not included but can be ordered separately.

Effective Date April 1, 2018

Additional Kits

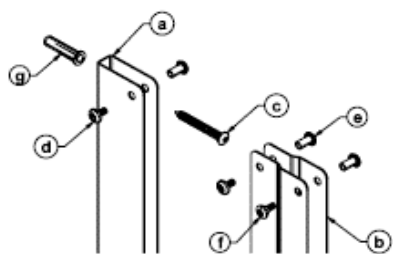
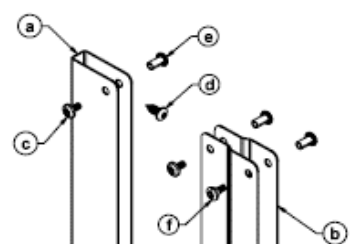
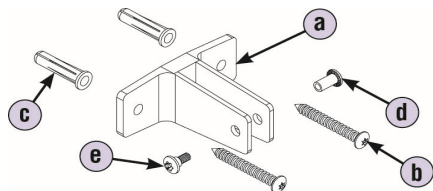
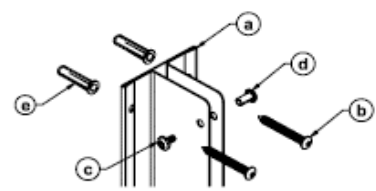
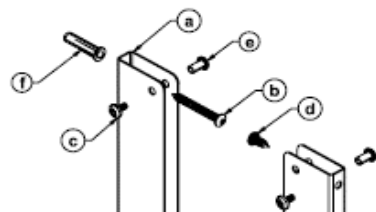
Dividing/Ending Alcove Panel Kit (Stainless Steel Continuous)	HDWC-S0477-57	List Price																								
	Includes:	\$ 239.00																								
	<table border="1"> <thead> <tr> <th>Part No.</th> <th>Description</th> <th>Qty.</th> </tr> </thead> <tbody> <tr> <td>a</td> <td>C190-02-57 Bracket, "U" Continuous, 2" x 57"</td> <td>1</td> </tr> <tr> <td>b</td> <td>HDWT-S0290-57 Bracket, Continuous Alcove, Offset</td> <td>2</td> </tr> <tr> <td>c</td> <td>FAST-P002 Screw #14 x 2" BTN Sheet Metal Torx-T27 w/Pin SS</td> <td>5</td> </tr> <tr> <td>d</td> <td>FAST-S0015 Screw #10-24 x 3/8" Machine Torx-T27 SS</td> <td>10</td> </tr> <tr> <td>e</td> <td>FAST-S0017 Screw #10-24 x 1/2" BTN Barrel-Female w/Pin SS</td> <td>15</td> </tr> <tr> <td>f</td> <td>FAST-S0018 Screw #10-24 x 1/2" Shoulder Torx-T27 SS</td> <td>5</td> </tr> <tr> <td>g</td> <td>FAST-T373 Anchor - Plastic #14-16 x 1 1/8" Lg.</td> <td>5</td> </tr> </tbody> </table>	Part No.	Description	Qty.	a	C190-02-57 Bracket, "U" Continuous, 2" x 57"	1	b	HDWT-S0290-57 Bracket, Continuous Alcove, Offset	2	c	FAST-P002 Screw #14 x 2" BTN Sheet Metal Torx-T27 w/Pin SS	5	d	FAST-S0015 Screw #10-24 x 3/8" Machine Torx-T27 SS	10	e	FAST-S0017 Screw #10-24 x 1/2" BTN Barrel-Female w/Pin SS	15	f	FAST-S0018 Screw #10-24 x 1/2" Shoulder Torx-T27 SS	5	g	FAST-T373 Anchor - Plastic #14-16 x 1 1/8" Lg.	5	
	Part No.	Description	Qty.																							
	a	C190-02-57 Bracket, "U" Continuous, 2" x 57"	1																							
	b	HDWT-S0290-57 Bracket, Continuous Alcove, Offset	2																							
	c	FAST-P002 Screw #14 x 2" BTN Sheet Metal Torx-T27 w/Pin SS	5																							
	d	FAST-S0015 Screw #10-24 x 3/8" Machine Torx-T27 SS	10																							
	e	FAST-S0017 Screw #10-24 x 1/2" BTN Barrel-Female w/Pin SS	15																							
	f	FAST-S0018 Screw #10-24 x 1/2" Shoulder Torx-T27 SS	5																							
	g	FAST-T373 Anchor - Plastic #14-16 x 1 1/8" Lg.	5																							
NOTE: Torx bits are not included but can be ordered separately.																										
Dividing/Ending Alcove Panel @ Panel Kit (Stainless Continuous)	HDWC-S0478-57	List Price																								
	Includes:	\$ 239.00																								
	<table border="1"> <thead> <tr> <th>Part No.</th> <th>Description</th> <th>Qty.</th> </tr> </thead> <tbody> <tr> <td>a</td> <td>C190-02-57 Bracket, "U" Continuous, 2" x 57"</td> <td>1</td> </tr> <tr> <td>b</td> <td>HDWT-S0290-57 Bracket, Continuous Alcove, Offset</td> <td>2</td> </tr> <tr> <td>c</td> <td>FAST-S0015 Screw #10-24 x 3/8" Machine Torx-T27 SS</td> <td>10</td> </tr> <tr> <td>d</td> <td>FAST-S0016 Screw #14 x 3/8" Sheet Metal Torx-T27 SS</td> <td>5</td> </tr> <tr> <td>e</td> <td>FAST-S0017 Screw #10-24 x 1/2" BTN Barrel-Female w/Pin SS</td> <td>15</td> </tr> <tr> <td>f</td> <td>FAST-S0018 Screw #10-24 x 1/2" Shoulder Torx-T27 SS</td> <td>5</td> </tr> </tbody> </table>	Part No.	Description	Qty.	a	C190-02-57 Bracket, "U" Continuous, 2" x 57"	1	b	HDWT-S0290-57 Bracket, Continuous Alcove, Offset	2	c	FAST-S0015 Screw #10-24 x 3/8" Machine Torx-T27 SS	10	d	FAST-S0016 Screw #14 x 3/8" Sheet Metal Torx-T27 SS	5	e	FAST-S0017 Screw #10-24 x 1/2" BTN Barrel-Female w/Pin SS	15	f	FAST-S0018 Screw #10-24 x 1/2" Shoulder Torx-T27 SS	5				
	Part No.	Description	Qty.																							
	a	C190-02-57 Bracket, "U" Continuous, 2" x 57"	1																							
	b	HDWT-S0290-57 Bracket, Continuous Alcove, Offset	2																							
	c	FAST-S0015 Screw #10-24 x 3/8" Machine Torx-T27 SS	10																							
	d	FAST-S0016 Screw #14 x 3/8" Sheet Metal Torx-T27 SS	5																							
e	FAST-S0017 Screw #10-24 x 1/2" BTN Barrel-Female w/Pin SS	15																								
f	FAST-S0018 Screw #10-24 x 1/2" Shoulder Torx-T27 SS	5																								
NOTE: Torx bits are not included but can be ordered separately.																										
Urinal Screen Bracket Kit	HDWC-S5US	List Price																								
	Includes:	\$ 38.00																								
	<table border="1"> <thead> <tr> <th>Part No.</th> <th>Description</th> <th>Qty.</th> </tr> </thead> <tbody> <tr> <td>a</td> <td>HDWC-S334 Bracket, 2-Ear, Wall</td> <td>3</td> </tr> <tr> <td>b</td> <td>FAST-P002 Screw #14 x 2" BTN Sheet Metal Torx-T27 w/Pin SS</td> <td>6</td> </tr> <tr> <td>c</td> <td>FAST-T373 Anchor - Plastic #14-16 x 1 1/8" Lg.</td> <td>6</td> </tr> <tr> <td>d</td> <td>FAST-S0017 Screw #10-24 x 1/2" BTN Barrel-Female w/Pin SS</td> <td>3</td> </tr> <tr> <td>e</td> <td>FAST-S0018 Screw #10-24 x 1/2" Shoulder Torx-T27 SS</td> <td>3</td> </tr> </tbody> </table>	Part No.	Description	Qty.	a	HDWC-S334 Bracket, 2-Ear, Wall	3	b	FAST-P002 Screw #14 x 2" BTN Sheet Metal Torx-T27 w/Pin SS	6	c	FAST-T373 Anchor - Plastic #14-16 x 1 1/8" Lg.	6	d	FAST-S0017 Screw #10-24 x 1/2" BTN Barrel-Female w/Pin SS	3	e	FAST-S0018 Screw #10-24 x 1/2" Shoulder Torx-T27 SS	3							
	Part No.	Description	Qty.																							
	a	HDWC-S334 Bracket, 2-Ear, Wall	3																							
	b	FAST-P002 Screw #14 x 2" BTN Sheet Metal Torx-T27 w/Pin SS	6																							
	c	FAST-T373 Anchor - Plastic #14-16 x 1 1/8" Lg.	6																							
d	FAST-S0017 Screw #10-24 x 1/2" BTN Barrel-Female w/Pin SS	3																								
e	FAST-S0018 Screw #10-24 x 1/2" Shoulder Torx-T27 SS	3																								
NOTE: Torx bits are not included but can be ordered separately.																										
Urinal Screen Bracket Kit (Stainless Steel Continuous)	HDWC-S0482-47	List Price																								
	Includes:	\$ 107.00																								
	<table border="1"> <thead> <tr> <th>Part No.</th> <th>Description</th> <th>Qty.</th> </tr> </thead> <tbody> <tr> <td>a</td> <td>HDWC-S186-42 Bracket, 2-Ear, Continuous 1" x 47"</td> <td>1</td> </tr> <tr> <td>b</td> <td>FAST-P002 Screw #14 x 2" BTN Sheet Metal Torx-T27 w/Pin SS</td> <td>8</td> </tr> <tr> <td>c</td> <td>FAST-S0015 Screw #10-24 x 3/8" Machine Torx-T27 SS</td> <td>4</td> </tr> <tr> <td>d</td> <td>FAST-S0017 Screw #10-24 x 1/2" BTN Barrel-Female w/Pin SS</td> <td>4</td> </tr> <tr> <td>e</td> <td>FAST-T373 Anchor - Plastic #14-16 x 1 1/8" Lg.</td> <td>8</td> </tr> </tbody> </table>	Part No.	Description	Qty.	a	HDWC-S186-42 Bracket, 2-Ear, Continuous 1" x 47"	1	b	FAST-P002 Screw #14 x 2" BTN Sheet Metal Torx-T27 w/Pin SS	8	c	FAST-S0015 Screw #10-24 x 3/8" Machine Torx-T27 SS	4	d	FAST-S0017 Screw #10-24 x 1/2" BTN Barrel-Female w/Pin SS	4	e	FAST-T373 Anchor - Plastic #14-16 x 1 1/8" Lg.	8							
	Part No.	Description	Qty.																							
	a	HDWC-S186-42 Bracket, 2-Ear, Continuous 1" x 47"	1																							
	b	FAST-P002 Screw #14 x 2" BTN Sheet Metal Torx-T27 w/Pin SS	8																							
	c	FAST-S0015 Screw #10-24 x 3/8" Machine Torx-T27 SS	4																							
d	FAST-S0017 Screw #10-24 x 1/2" BTN Barrel-Female w/Pin SS	4																								
e	FAST-T373 Anchor - Plastic #14-16 x 1 1/8" Lg.	8																								
Also available in 41" Height - HDWC-S0482-41		\$ 84.00																								
NOTE: Torx bits are not included but can be ordered separately.																										
Dividing Urinal Screen Bracket Kit (Stn. Steel Cont.)	HDWC-S0475-47	List Price																								
	Includes:	\$ 149.00																								
	<table border="1"> <thead> <tr> <th>Part No.</th> <th>Description</th> <th>Qty.</th> </tr> </thead> <tbody> <tr> <td>a</td> <td>C190-02-47 Bracket, "U" Continuous, 2" x 47"</td> <td>2</td> </tr> <tr> <td>b</td> <td>FAST-P002 Screw #14 x 2" BTN Sheet Metal Torx-T27 w/Pin SS</td> <td>4</td> </tr> <tr> <td>c</td> <td>FAST-S0015 Screw #10-24 x 3/8" Machine Torx-T27 SS</td> <td>8</td> </tr> <tr> <td>d</td> <td>FAST-S0016 Screw #14 x 3/8" Sheet Metal Torx-T27 SS</td> <td>4</td> </tr> <tr> <td>e</td> <td>FAST-S0017 Screw #10-24 x 1/2" BTN Barrel-Female w/Pin SS</td> <td>8</td> </tr> <tr> <td>f</td> <td>FAST-T373 Anchor - Plastic #14-16 x 1 1/8" Lg.</td> <td>4</td> </tr> </tbody> </table>	Part No.	Description	Qty.	a	C190-02-47 Bracket, "U" Continuous, 2" x 47"	2	b	FAST-P002 Screw #14 x 2" BTN Sheet Metal Torx-T27 w/Pin SS	4	c	FAST-S0015 Screw #10-24 x 3/8" Machine Torx-T27 SS	8	d	FAST-S0016 Screw #14 x 3/8" Sheet Metal Torx-T27 SS	4	e	FAST-S0017 Screw #10-24 x 1/2" BTN Barrel-Female w/Pin SS	8	f	FAST-T373 Anchor - Plastic #14-16 x 1 1/8" Lg.	4				
	Part No.	Description	Qty.																							
	a	C190-02-47 Bracket, "U" Continuous, 2" x 47"	2																							
	b	FAST-P002 Screw #14 x 2" BTN Sheet Metal Torx-T27 w/Pin SS	4																							
	c	FAST-S0015 Screw #10-24 x 3/8" Machine Torx-T27 SS	8																							
	d	FAST-S0016 Screw #14 x 3/8" Sheet Metal Torx-T27 SS	4																							
e	FAST-S0017 Screw #10-24 x 1/2" BTN Barrel-Female w/Pin SS	8																								
f	FAST-T373 Anchor - Plastic #14-16 x 1 1/8" Lg.	4																								
Also available in 41" Height - HDWC-S0475-41		\$ 130.00																								
NOTE: Torx bits are not included but can be ordered separately.																										

Prices subject to change without notice.
Items may be changed or discontinued
without notice and without incurring obligation.

Effective Date April 1, 2018

Additional Kits

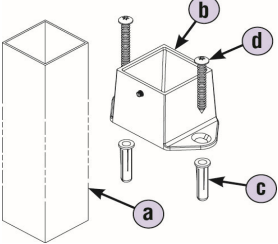
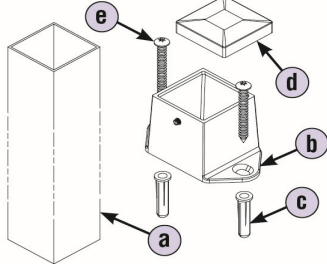
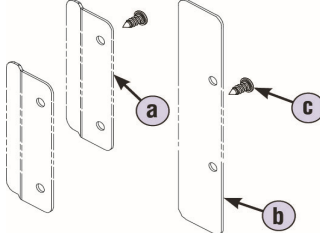
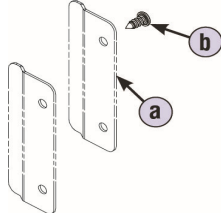
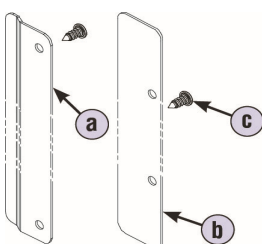
Floor-To-Ceiling Aluminum Post with Shoes	HDWT-Z0194	List Price																		
	Includes:																			
	<table border="1"> <thead> <tr> <th>Part No.</th> <th>Description</th> <th>Qty.</th> </tr> </thead> <tbody> <tr> <td>a</td> <td>T462-120 Aluminum Post 120"</td> <td>1</td> </tr> <tr> <td>b</td> <td>HDWT-T284 Shoe for 1 3/4" Aluminum Post</td> <td>2</td> </tr> <tr> <td>c</td> <td>FAST-T373 Anchor - Plastic #14-16 x 1 3/8" Lg.</td> <td>4</td> </tr> <tr> <td>d</td> <td>FAST-Z002 Screw #14 x 2" Sheet Metal Torx-T27 w/Pin ZP</td> <td>4</td> </tr> </tbody> </table>	Part No.	Description	Qty.	a	T462-120 Aluminum Post 120"	1	b	HDWT-T284 Shoe for 1 3/4" Aluminum Post	2	c	FAST-T373 Anchor - Plastic #14-16 x 1 3/8" Lg.	4	d	FAST-Z002 Screw #14 x 2" Sheet Metal Torx-T27 w/Pin ZP	4	\$ 103.00			
	Part No.	Description	Qty.																	
	a	T462-120 Aluminum Post 120"	1																	
	b	HDWT-T284 Shoe for 1 3/4" Aluminum Post	2																	
c	FAST-T373 Anchor - Plastic #14-16 x 1 3/8" Lg.	4																		
d	FAST-Z002 Screw #14 x 2" Sheet Metal Torx-T27 w/Pin ZP	4																		
NOTE: Torx bits are not included but can be ordered separately.																				
Floor-Braced Aluminum Post with Shoes and Cap	HDWT-Z0195	List Price																		
	Includes:																			
	<table border="1"> <thead> <tr> <th>Part No.</th> <th>Description</th> <th>Qty.</th> </tr> </thead> <tbody> <tr> <td>a</td> <td>T462-060 Aluminum Post 60"</td> <td>1</td> </tr> <tr> <td>b</td> <td>HDWT-T284 Shoe for 1 3/4" Aluminum Post</td> <td>1</td> </tr> <tr> <td>c</td> <td>FAST-T373 Anchor - Plastic #14-16 x 1 3/8" Lg.</td> <td>2</td> </tr> <tr> <td>d</td> <td>HDWT-T181 Cap for 1 3/4" Aluminum Post</td> <td>1</td> </tr> <tr> <td>e</td> <td>FAST-Z002 Screw #14 x 2" Sheet Metal Torx-T27 w/Pin ZP</td> <td>2</td> </tr> </tbody> </table>	Part No.	Description	Qty.	a	T462-060 Aluminum Post 60"	1	b	HDWT-T284 Shoe for 1 3/4" Aluminum Post	1	c	FAST-T373 Anchor - Plastic #14-16 x 1 3/8" Lg.	2	d	HDWT-T181 Cap for 1 3/4" Aluminum Post	1	e	FAST-Z002 Screw #14 x 2" Sheet Metal Torx-T27 w/Pin ZP	2	\$ 72.00
	Part No.	Description	Qty.																	
	a	T462-060 Aluminum Post 60"	1																	
	b	HDWT-T284 Shoe for 1 3/4" Aluminum Post	1																	
c	FAST-T373 Anchor - Plastic #14-16 x 1 3/8" Lg.	2																		
d	HDWT-T181 Cap for 1 3/4" Aluminum Post	1																		
e	FAST-Z002 Screw #14 x 2" Sheet Metal Torx-T27 w/Pin ZP	2																		
NOTE: Torx bits are not included but can be ordered separately.																				
No-Site Strips, Inswing Latch and Hinge Sides	HDWC-S0421	List Price																		
	Includes:																			
	<table border="1"> <thead> <tr> <th>Part No.</th> <th>Description</th> <th>Qty.</th> </tr> </thead> <tbody> <tr> <td>a</td> <td>HDWC-S0419 No-Site Strip, Latch Side 1-5/8"W x 25"H</td> <td>2</td> </tr> <tr> <td>b</td> <td>HDWC-S0420 No-Site Strip, Hinge Side 1-3/8"W x 46"H</td> <td>1</td> </tr> <tr> <td>c</td> <td>FAST-S355A Screw 1/4-14 x 5/8" Sheet Metal Torx-T27 w/Pin SS</td> <td>12</td> </tr> </tbody> </table>	Part No.	Description	Qty.	a	HDWC-S0419 No-Site Strip, Latch Side 1-5/8"W x 25"H	2	b	HDWC-S0420 No-Site Strip, Hinge Side 1-3/8"W x 46"H	1	c	FAST-S355A Screw 1/4-14 x 5/8" Sheet Metal Torx-T27 w/Pin SS	12	\$ 40.00						
	Part No.	Description	Qty.																	
	a	HDWC-S0419 No-Site Strip, Latch Side 1-5/8"W x 25"H	2																	
b	HDWC-S0420 No-Site Strip, Hinge Side 1-3/8"W x 46"H	1																		
c	FAST-S355A Screw 1/4-14 x 5/8" Sheet Metal Torx-T27 w/Pin SS	12																		
NOTE: Torx bits are not included but can be ordered separately.																				
No-Site Strips, Inswing Latch Side	HDWC-S0422	List Price																		
	Includes:																			
	<table border="1"> <thead> <tr> <th>Part No.</th> <th>Description</th> <th>Qty.</th> </tr> </thead> <tbody> <tr> <td>a</td> <td>HDWC-S0419 No-Site Strip, Latch Side 1-5/8"W x 25"H</td> <td>2</td> </tr> <tr> <td>b</td> <td>FAST-S355A Screw 1/4-14 x 5/8" Sheet Metal Torx-T27 w/Pin SS</td> <td>8</td> </tr> </tbody> </table>	Part No.	Description	Qty.	a	HDWC-S0419 No-Site Strip, Latch Side 1-5/8"W x 25"H	2	b	FAST-S355A Screw 1/4-14 x 5/8" Sheet Metal Torx-T27 w/Pin SS	8	\$ 27.00									
	Part No.	Description	Qty.																	
a	HDWC-S0419 No-Site Strip, Latch Side 1-5/8"W x 25"H	2																		
b	FAST-S355A Screw 1/4-14 x 5/8" Sheet Metal Torx-T27 w/Pin SS	8																		
NOTE: Torx bits are not included but can be ordered separately.																				
No-Site Strips, Outswing Latch and Hinge Sides	HDWC-S0424	List Price																		
	Includes:																			
	<table border="1"> <thead> <tr> <th>Part No.</th> <th>Description</th> <th>Qty.</th> </tr> </thead> <tbody> <tr> <td>a</td> <td>HDWC-S0420 No-Site Strip, Hinge Side 1-3/8"W x 46"H</td> <td>1</td> </tr> <tr> <td>b</td> <td>HDWC-S0423 No-Site Strip, Latch Side 1-5/8"W x 57"H</td> <td>1</td> </tr> <tr> <td>c</td> <td>FAST-S355A Screw 1/4-14 x 5/8" Sheet Metal Torx-T27 w/Pin SS</td> <td>10</td> </tr> </tbody> </table>	Part No.	Description	Qty.	a	HDWC-S0420 No-Site Strip, Hinge Side 1-3/8"W x 46"H	1	b	HDWC-S0423 No-Site Strip, Latch Side 1-5/8"W x 57"H	1	c	FAST-S355A Screw 1/4-14 x 5/8" Sheet Metal Torx-T27 w/Pin SS	10	\$ 35.00						
	Part No.	Description	Qty.																	
	a	HDWC-S0420 No-Site Strip, Hinge Side 1-3/8"W x 46"H	1																	
b	HDWC-S0423 No-Site Strip, Latch Side 1-5/8"W x 57"H	1																		
c	FAST-S355A Screw 1/4-14 x 5/8" Sheet Metal Torx-T27 w/Pin SS	10																		
NOTE: Torx bits are not included but can be ordered separately.																				

Effective Date April 1, 2018

Additional Kits

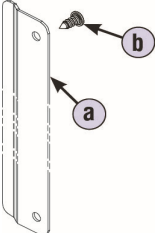
No-Site Strips, Outswing Latch Side	HDWC-S0425	List Price									
	Includes:	\$ 22.00									
	<table border="1"> <thead> <tr> <th>Part No.</th> <th>Description</th> <th>Qty.</th> </tr> </thead> <tbody> <tr> <td>a</td> <td>HDWC-S0423 No-Site Strip, Latch Side 1-5/8"W x 57"H</td> <td>1</td> </tr> <tr> <td>b</td> <td>FAST-S355A Screw 1/4-14 x 5/8" Sheet Metal Torx-T27 w/Pin SS</td> <td>5</td> </tr> </tbody> </table>	Part No.	Description	Qty.	a	HDWC-S0423 No-Site Strip, Latch Side 1-5/8"W x 57"H	1	b	FAST-S355A Screw 1/4-14 x 5/8" Sheet Metal Torx-T27 w/Pin SS	5	
	Part No.	Description	Qty.								
a	HDWC-S0423 No-Site Strip, Latch Side 1-5/8"W x 57"H	1									
b	FAST-S355A Screw 1/4-14 x 5/8" Sheet Metal Torx-T27 w/Pin SS	5									

NOTE: Torx bits are not included but can be ordered separately.

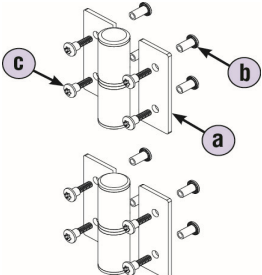
Top and Bottom Hinge Kit (LHI/RHO)	HDWC-S0278	List Price												
	Includes:	\$ 65.00												
	<table border="1"> <thead> <tr> <th>Part No.</th> <th>Description</th> <th>Qty.</th> </tr> </thead> <tbody> <tr> <td>a</td> <td>HDWC-S0211 Surface-Mounted Hinge (LHI/RHO)</td> <td>1</td> </tr> <tr> <td>b</td> <td>FAST-S0017 Screw #10-24 x 1/2" BTN Barrel-Female w/Pin SS</td> <td>8</td> </tr> <tr> <td>c</td> <td>FAST-P004 Screw #10-24 x 3/4" BTN Step-Male Torx-T27</td> <td>8</td> </tr> </tbody> </table>	Part No.	Description	Qty.	a	HDWC-S0211 Surface-Mounted Hinge (LHI/RHO)	1	b	FAST-S0017 Screw #10-24 x 1/2" BTN Barrel-Female w/Pin SS	8	c	FAST-P004 Screw #10-24 x 3/4" BTN Step-Male Torx-T27	8	
	Part No.	Description	Qty.											
a	HDWC-S0211 Surface-Mounted Hinge (LHI/RHO)	1												
b	FAST-S0017 Screw #10-24 x 1/2" BTN Barrel-Female w/Pin SS	8												
c	FAST-P004 Screw #10-24 x 3/4" BTN Step-Male Torx-T27	8												

NOTE: Torx bits are not included but can be ordered separately.

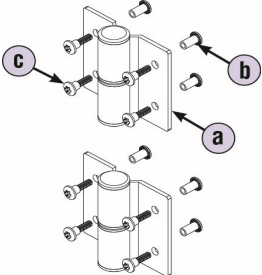
Top and Bottom Hinge Kit (RHI/LHO)	HDWC-S0279	List Price												
	Includes:	\$ 65.00												
	<table border="1"> <thead> <tr> <th>Part No.</th> <th>Description</th> <th>Qty.</th> </tr> </thead> <tbody> <tr> <td>a</td> <td>HDWC-S0212 Surface-Mounted Hinge (RHI/LHO)</td> <td>1</td> </tr> <tr> <td>b</td> <td>FAST-S0017 Screw #10-24 x 1/2" BTN Barrel-Female w/Pin SS</td> <td>8</td> </tr> <tr> <td>c</td> <td>FAST-P004 Screw #10-24 x 3/4" BTN Step-Male Torx-T27</td> <td>8</td> </tr> </tbody> </table>	Part No.	Description	Qty.	a	HDWC-S0212 Surface-Mounted Hinge (RHI/LHO)	1	b	FAST-S0017 Screw #10-24 x 1/2" BTN Barrel-Female w/Pin SS	8	c	FAST-P004 Screw #10-24 x 3/4" BTN Step-Male Torx-T27	8	
	Part No.	Description	Qty.											
a	HDWC-S0212 Surface-Mounted Hinge (RHI/LHO)	1												
b	FAST-S0017 Screw #10-24 x 1/2" BTN Barrel-Female w/Pin SS	8												
c	FAST-P004 Screw #10-24 x 3/4" BTN Step-Male Torx-T27	8												

NOTE: Torx bits are not included but can be ordered separately.

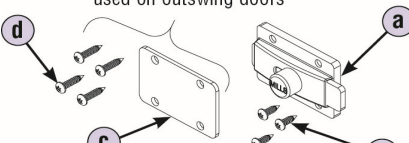
Slide Latch Inswing/Outswing Kit	HDWC-S0109	List Price															
<p>used on outswing doors</p> 	Includes:	\$ 27.00															
	<table border="1"> <thead> <tr> <th>Part No.</th> <th>Description</th> <th>Qty.</th> </tr> </thead> <tbody> <tr> <td>a</td> <td>HDWL-S160 Slide Latch</td> <td>1</td> </tr> <tr> <td>b</td> <td>FAST-S0019 Screw #10 x 5/8" BTN Sheet Metal Torx-T25 w/Pin SS</td> <td>4</td> </tr> <tr> <td>c</td> <td>HDWL-P0036 Spacer</td> <td>1</td> </tr> <tr> <td>d</td> <td>FAST-S0028 Screw #10-24 x 1" Sheet Metal Torx-T27 SS</td> <td>4</td> </tr> </tbody> </table>	Part No.	Description	Qty.	a	HDWL-S160 Slide Latch	1	b	FAST-S0019 Screw #10 x 5/8" BTN Sheet Metal Torx-T25 w/Pin SS	4	c	HDWL-P0036 Spacer	1	d	FAST-S0028 Screw #10-24 x 1" Sheet Metal Torx-T27 SS	4	
	Part No.	Description	Qty.														
a	HDWL-S160 Slide Latch	1															
b	FAST-S0019 Screw #10 x 5/8" BTN Sheet Metal Torx-T25 w/Pin SS	4															
c	HDWL-P0036 Spacer	1															
d	FAST-S0028 Screw #10-24 x 1" Sheet Metal Torx-T27 SS	4															

NOTE: Torx bits are not included but can be ordered separately.

Effective Date April 1, 2018

Additional Kits

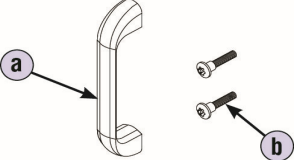
	Door Pull Kit		HDWC-S0110	List Price										
	Includes:		\$ 39.00											
	<table border="1"> <thead> <tr> <th></th> <th>Part No.</th> <th>Description</th> <th>Qty.</th> </tr> </thead> <tbody> <tr> <td>a</td> <td>HDWT-S282</td> <td>Door Pull</td> <td>1</td> </tr> <tr> <td>b</td> <td>FAST-P004A</td> <td>Screw #10-24 x 1" Shoulder Torx-T27</td> <td>2</td> </tr> </tbody> </table>		Part No.	Description	Qty.	a	HDWT-S282	Door Pull	1	b	FAST-P004A	Screw #10-24 x 1" Shoulder Torx-T27	2	NOTE: Torx bits are not included but can be ordered separately.
	Part No.	Description	Qty.											
a	HDWT-S282	Door Pull	1											
b	FAST-P004A	Screw #10-24 x 1" Shoulder Torx-T27	2											

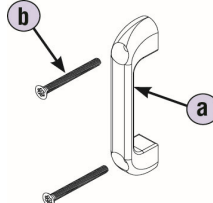
	Door Pull with Countersink Kit		HDW0-S0168	List Price										
	Includes:		\$ 24.00											
	<table border="1"> <thead> <tr> <th></th> <th>Part No.</th> <th>Description</th> <th>Qty.</th> </tr> </thead> <tbody> <tr> <td>a</td> <td>HDW0-S0167</td> <td>Door Pull with Countersink SS</td> <td>1</td> </tr> <tr> <td>b</td> <td>FAST-S0027</td> <td>Screw #10-24 x 2" Flat Machine Torx SS</td> <td>2</td> </tr> </tbody> </table>		Part No.	Description	Qty.	a	HDW0-S0167	Door Pull with Countersink SS	1	b	FAST-S0027	Screw #10-24 x 2" Flat Machine Torx SS	2	NOTE: Torx bits are not included but can be ordered separately.
	Part No.	Description	Qty.											
a	HDW0-S0167	Door Pull with Countersink SS	1											
b	FAST-S0027	Screw #10-24 x 2" Flat Machine Torx SS	2											

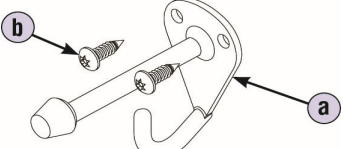
	Coat Hook Inswing Kit		HDWC-S0011	List Price										
	Includes:		\$ 13.00											
	<table border="1"> <thead> <tr> <th></th> <th>Part No.</th> <th>Description</th> <th>Qty.</th> </tr> </thead> <tbody> <tr> <td>a</td> <td>HDWT-S285</td> <td>Coat Hook with Bumper</td> <td>1</td> </tr> <tr> <td>b</td> <td>FAST-S0019</td> <td>Screw #10 x 3/8" BTN Sheet Metal Torx-T25 w/Pin SS</td> <td>2</td> </tr> </tbody> </table>		Part No.	Description	Qty.	a	HDWT-S285	Coat Hook with Bumper	1	b	FAST-S0019	Screw #10 x 3/8" BTN Sheet Metal Torx-T25 w/Pin SS	2	NOTE: Torx bits are not included but can be ordered separately.
	Part No.	Description	Qty.											
a	HDWT-S285	Coat Hook with Bumper	1											
b	FAST-S0019	Screw #10 x 3/8" BTN Sheet Metal Torx-T25 w/Pin SS	2											

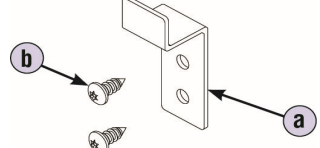
	Coat Hook Outswing Kit		HDWC-S0013	List Price										
	Includes:		\$ 11.00											
	<table border="1"> <thead> <tr> <th></th> <th>Part No.</th> <th>Description</th> <th>Qty.</th> </tr> </thead> <tbody> <tr> <td>a</td> <td>HDWT-S275</td> <td>Coat Hook, Outswing</td> <td>1</td> </tr> <tr> <td>b</td> <td>FAST-S0016</td> <td>Screw #14 x 3/8" Sheet Metal Torx-T27 SS</td> <td>2</td> </tr> </tbody> </table>		Part No.	Description	Qty.	a	HDWT-S275	Coat Hook, Outswing	1	b	FAST-S0016	Screw #14 x 3/8" Sheet Metal Torx-T27 SS	2	NOTE: Torx bits are not included but can be ordered separately.
	Part No.	Description	Qty.											
a	HDWT-S275	Coat Hook, Outswing	1											
b	FAST-S0016	Screw #14 x 3/8" Sheet Metal Torx-T27 SS	2											

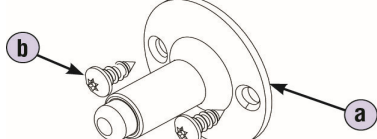
	Wall Bumper Kit		HDWC-S283	List Price										
	Includes:		\$ 24.00											
	<table border="1"> <thead> <tr> <th></th> <th>Part No.</th> <th>Description</th> <th>Qty.</th> </tr> </thead> <tbody> <tr> <td>a</td> <td>HDWT-S177</td> <td>Wall Bumper</td> <td>1</td> </tr> <tr> <td>b</td> <td>FAST-S0019</td> <td>Screw #10 x 3/8" BTN Sheet Metal Torx-T25 w/Pin SS</td> <td>2</td> </tr> </tbody> </table>		Part No.	Description	Qty.	a	HDWT-S177	Wall Bumper	1	b	FAST-S0019	Screw #10 x 3/8" BTN Sheet Metal Torx-T25 w/Pin SS	2	NOTE: Torx bits are not included but can be ordered separately.
	Part No.	Description	Qty.											
a	HDWT-S177	Wall Bumper	1											
b	FAST-S0019	Screw #10 x 3/8" BTN Sheet Metal Torx-T25 w/Pin SS	2											

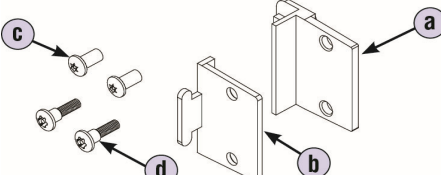
	Strike/Keeper Inswing Kit		HDWC-S0050	List Price																			
	Includes:		\$ 24.00																				
	<table border="1"> <thead> <tr> <th></th> <th>Part No.</th> <th>Description</th> <th>Qty.</th> </tr> </thead> <tbody> <tr> <td>a</td> <td>HDWC-S919</td> <td>Door Stop Inswing</td> <td>1</td> </tr> <tr> <td>b</td> <td>HDWL-S918</td> <td>Door Keeper</td> <td>1</td> </tr> <tr> <td>c</td> <td>FAST-P004</td> <td>Screw #10-24 x 3/4" BTN Step-Male Torx-T27</td> <td>2</td> </tr> <tr> <td>d</td> <td>FAST-S0017</td> <td>Screw #10-24 x 1/2" BTN Barrel-Female w/Pin SS</td> <td>2</td> </tr> </tbody> </table>		Part No.	Description	Qty.	a	HDWC-S919	Door Stop Inswing	1	b	HDWL-S918	Door Keeper	1	c	FAST-P004	Screw #10-24 x 3/4" BTN Step-Male Torx-T27	2	d	FAST-S0017	Screw #10-24 x 1/2" BTN Barrel-Female w/Pin SS	2	NOTE: Torx bits are not included but can be ordered separately.	
		Part No.	Description	Qty.																			
	a	HDWC-S919	Door Stop Inswing	1																			
b	HDWL-S918	Door Keeper	1																				
c	FAST-P004	Screw #10-24 x 3/4" BTN Step-Male Torx-T27	2																				
d	FAST-S0017	Screw #10-24 x 1/2" BTN Barrel-Female w/Pin SS	2																				

Prices subject to change without notice.
Items may be changed or discontinued
without notice and without incurring obligation.

Effective Date April 1, 2018

Additional Kits

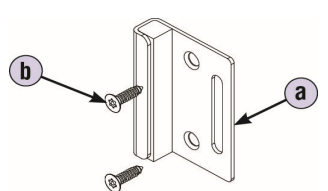
Strike/Keeper Flat Inswing Kit	HDWC-S0030	List Price		
	Includes:			
		Part No.	Description	Qty.
	a	HDWC-S0029	Flat Door Stop/Keeper	1
	b	FAST-S0006	Screw #10 x 3/4" FL Sheet Metal Torx-T25	2
NOTE: Torx bits are not included but can be ordered separately.			\$ 45.00	

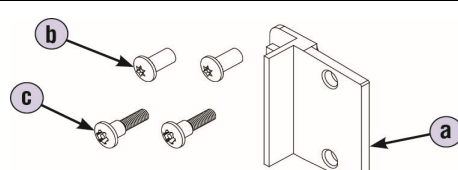
Strike/Keeper Outswing Kit	HDWC-S0052	List Price		
	Includes:			
		Part No.	Description	Qty.
	a	HDWC-S919	Door Stop Inswing	1
	b	FAST-S0017	Screw #10-24 x 1/2" BTN Barrel-Female w/Pin SS	2
c	FAST-P004	Screw #10-24 x 3/4" BTN Step-Male Torx-T27	2	
NOTE: Torx bits are not included but can be ordered separately.			\$ 26.00	

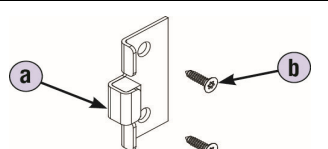
Strike/Keeper Flat Outswing Kit	HDWC-S0031	List Price		
	Includes:			
		Part No.	Description	Qty.
	a	HDWC-S0022	Flat Door Stop/Keeper	1
	b	FAST-S0006	Screw #10 x 3/4" FL Sheet Metal Torx-T25	2
NOTE: Torx bits are not included but can be ordered separately.			\$ 42.00	

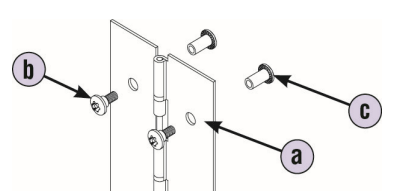
Continuous Stainless Steel Piano Hinge	HDWC-S0136 (RHI/LHO)	List Price		
	Includes:			
		Part No.	Description	Qty.
	a	HDWT-S0208	Piano Hinge, Continuous Stainless Steel	1
	b	FAST-S0017	Screw #10-24 x 1/2" BTN Barrel-Female w/Pin SS	12
c	FAST-S0018	Screw #10-24 x 1/2" Shoulder Torx-T27 SS	12	
NOTE: Torx bits are not included but can be ordered separately.			\$ 109.00	
	HDWC-S0137 (LHI/RHO)	List Price		
	Includes:			
	Part No.	Description	Qty.	
a	HDWT-S0209	Piano Hinge, Continuous Stainless Steel	1	
b	FAST-S0017	Screw #10-24 x 1/2" BTN Barrel-Female w/Pin SS	12	
c	FAST-S0018	Screw #10-24 x 1/2" Shoulder Torx-T27 SS	12	
NOTE: Torx bits are not included but can be ordered separately.			\$ 109.00	

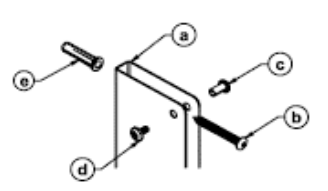
Pilaster Channel Kit	HDWC-S0495	List Price		
	Includes:			
		Part No.	Description	Qty.
	a	C192-02-57	Bracket, "U" Continuous 2" x 57"	1
	b	FAST-P002	Screw #14 x 2" BTN Sheet Metal Torx-T27 w/Pin SS	5
	c	FAST-S0017	Screw #10-24 x 1/2" BTN Barrel-Female w/Pin SS	5
	d	FAST-S0018	Screw #10-24 x 1/2" Shoulder Torx-T27 SS	5
e	FAST-T373	Anchor - Plastic #14-16 x 1-3/8" Lg.	5	
NOTE: Torx bits are not included but can be ordered separately.			\$ 89.00	

Effective Date April 1, 2018

Additional Kits

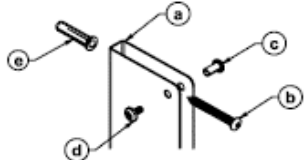
Pilaster Channel Kit 	HDWC-S0497			List Price
	Includes:			\$ 99.00
	Part No.	Description	Qty.	
a	C192-03-57	Bracket, "U" Continuous 3" x 57"	1	
b	FAST-P002	Screw #14 x 2" BTN Sheet Metal Torx-T27 w/Pin SS	5	
c	FAST-S0017	Screw #10-24 x 1/2" BTN Barrel-Female w/Pin SS	5	
d	FAST-S0018	Screw #10-24 x 1/2" Shoulder Torx-T27 SS	5	
e	FAST-T373	Anchor - Plastic #14-16 x 1-3/8" Lg.	5	

NOTE: Torx bits are not included but can be ordered separately.

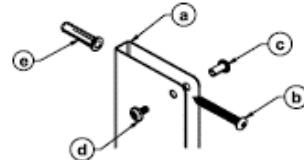
Panel Channel Kit 	HDWC-S0489			List Price
	Includes:			\$ 89.00
	Part No.	Description	Qty.	
a	C190-02-57	Bracket, "U" Continuous 2" x 57"	1	
b	FAST-P002	Screw #14 x 2" BTN Sheet Metal Torx-T27 w/Pin SS	5	
c	FAST-S0015	Screw #10-24 x 3/8" Machine Torx-T27 SS	5	
d	FAST-S0017	Screw #10-24 x 1/2" BTN Barrel-Female w/Pin SS	5	
e	FAST-T373	Anchor - Plastic #14-16 x 1-3/8" Lg.	5	

NOTE: Torx bits are not included but can be ordered separately.

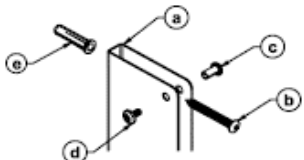
Panel Channel Kit 	HDWC-S0491			List Price
	Includes:			\$ 99.00
	Part No.	Description	Qty.	
a	C190-03-57	Bracket, "U" Continuous 3" x 57"	1	
b	FAST-P002	Screw #14 x 2" BTN Sheet Metal Torx-T27 w/Pin SS	5	
c	FAST-S0015	Screw #10-24 x 3/8" Machine Torx-T27 SS	5	
d	FAST-S0017	Screw #10-24 x 1/2" BTN Barrel-Female w/Pin SS	5	
e	FAST-T373	Anchor - Plastic #14-16 x 1-3/8" Lg.	5	

NOTE: Torx bits are not included but can be ordered separately.

Torx Bits 	Part No.	Description	Qty.	List Price
	HW101031	Torx Bit T27	1	\$ 5.30
	HW101030	Torx Bit T25	1	\$ 5.30

Curtain Hook for Headrail 	HDWP-COMHK	List Price
		\$ 2.10