

Mills Powder Coated and Stainless Steel Partitions Service Parts List Price Book 0418MSP

Effective Date April 1, 2018

Table of Contents

Layouts with Reference Numbers

Series 400 (Floor-Mount with Overhead Brace) and 500 (Floor-Braced)	2
Series 600 (Ceiling-Hung) and 700 (Floor-to-Ceiling)	3

Headrail Part Numbers and Kits

① Headrail	4
② Headrail Open-End Kit	4
③ Headrail Between-the-Wall Kit	4

Shoes and Sleeves

④ Shoe/Sleeve Kits	5-6
--------------------	-----

Inswing and Outswing Door Kits

⑤ Inswing Door Kits	7-12
⑥ Outswing Door Kits	13-17

Pilaster and Panel Kits

⑦ Pilaster at Wall "F" Kits	18-19
Pilaster at Pilaster/Panel "F" Kits	18-19
⑧⑨ Dividing/Ending Panel Kits and Ending Panel Kits	20-21

Additional Kits

Alcove Kits	22-23
Urinal Screen Bracket Kits	23-24
Post Kits	25-26
No-Site Kits	26
Hinge and Latch Kits	27-28
Door Pulls, Coat Hooks and Wall Bumpers	28
Strike/Keeper Kits	29
Continuous Stainless Steel Piano Hinge	30
Telescoping Pilaster Kits	31
Pilaster Channel Kits	32
Panel Channel Kits	33
Torx Bits	34
Curtain Hook for Headrail	34
Cam & Hinge Pin Kit	34
Paint, Touch-Up	34

Series 400 and Series 500 Layouts

Series 400
Floor-Mounted,
Overhead Braced

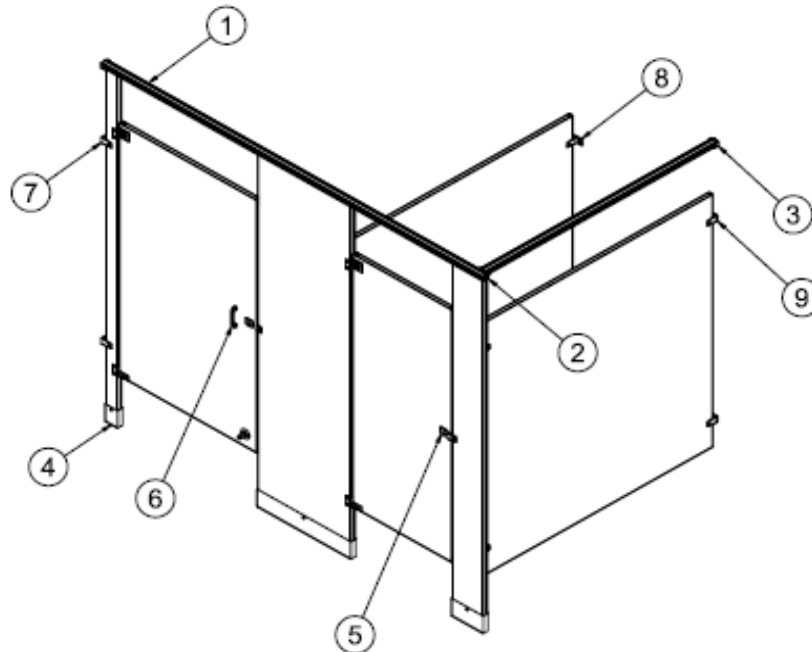

Series 500
Floor-Braced

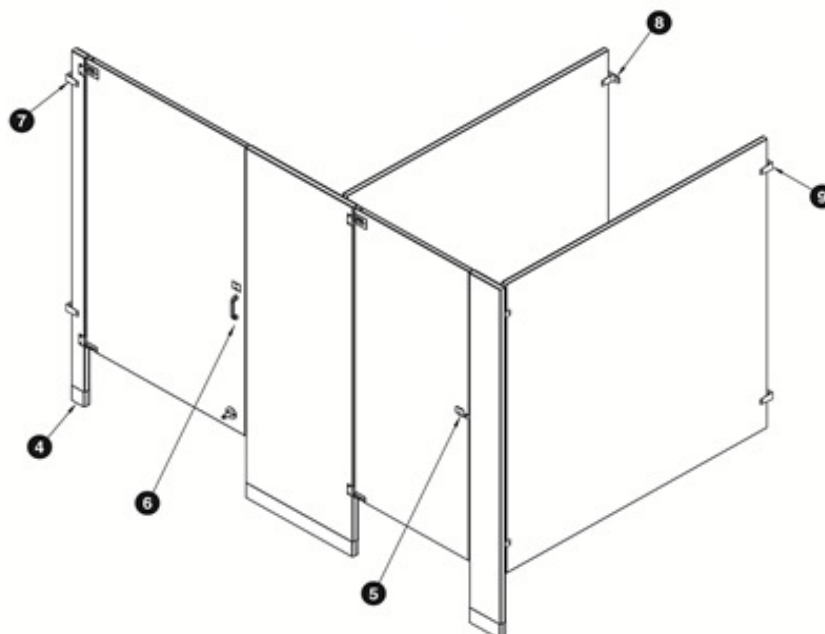

Series 600 and Series 700 Layouts

Series 600
Ceiling-Hung

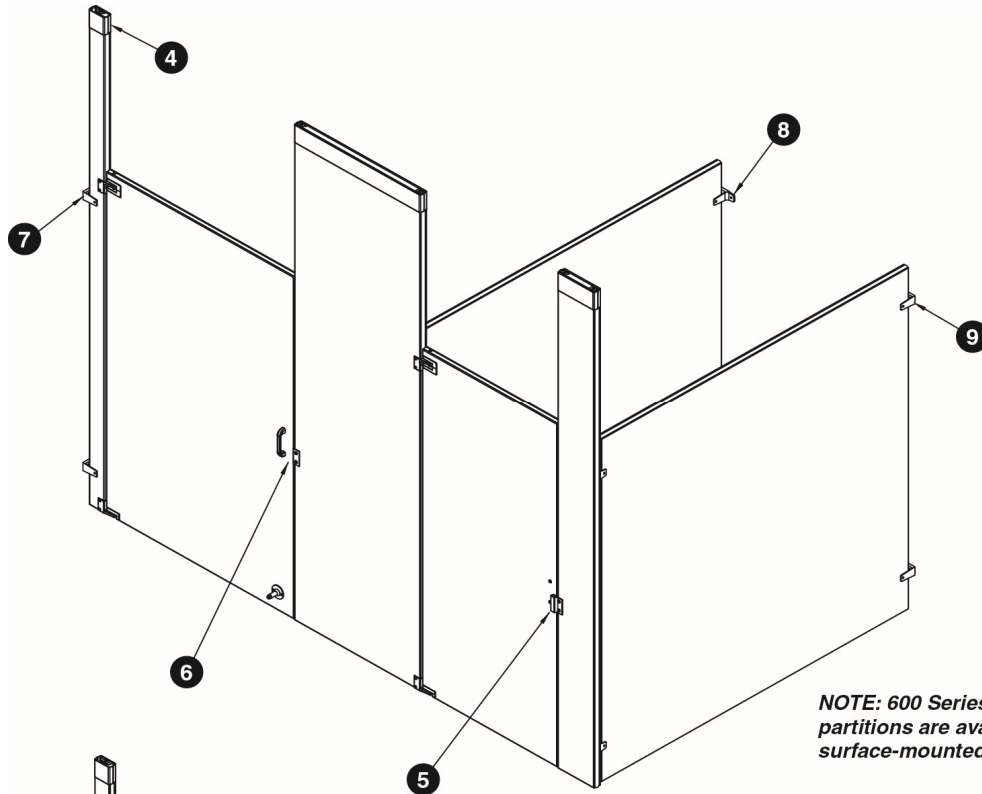

NOTE: 600 Series ceiling-hung partitions are available with surface-mounted slide latch only.

Series 700
Floor-to-Ceiling

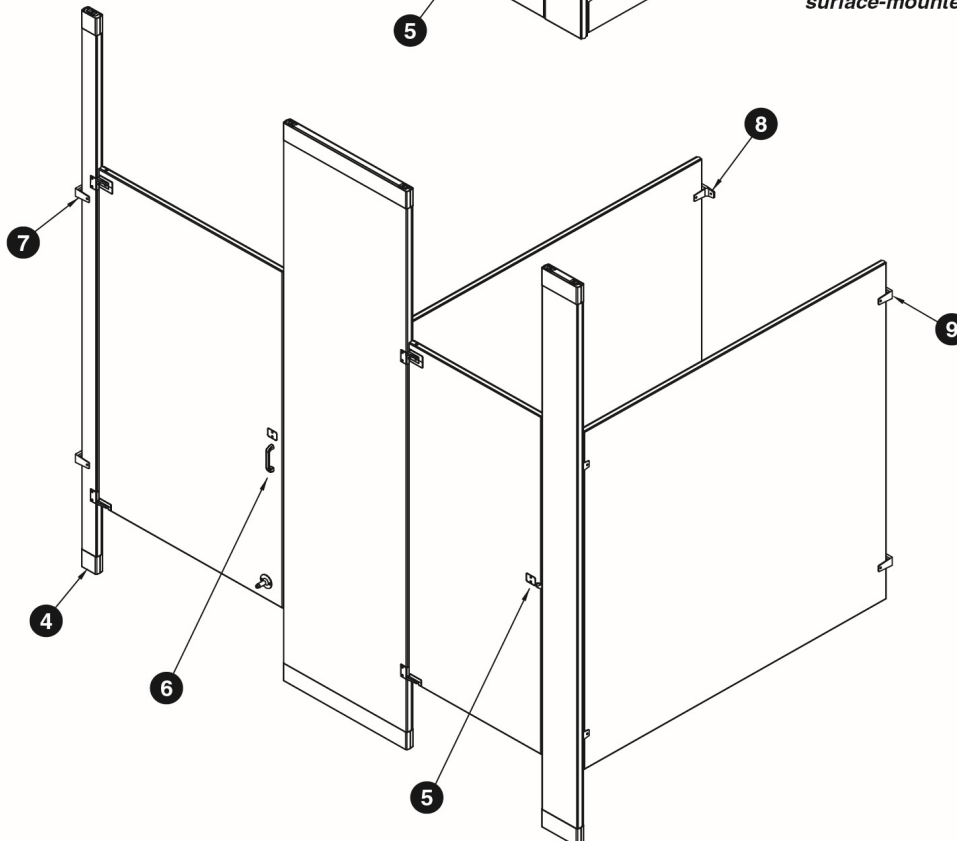

Effective Date April 1, 2018

Headrail and Headrail Kits

① Headrail only (mounting kits sold separately)	Part No.	Description	Qty.	List Price
	HDWT-A0458-037	Actual Size 37"	1	\$ 18.00
	HDWT-A0458-059	Actual Size 59"	1	\$ 26.00
	HDWT-A0458-062	Actual Size 62"	1	\$ 29.00
	HDWT-A0458-073	Actual Size 73"	1	\$ 36.00
	HDWT-A0458-084	Actual Size 84"	1	\$ 41.00
	HDWT-A0458-120	Actual Size 120"	1	\$ 61.00

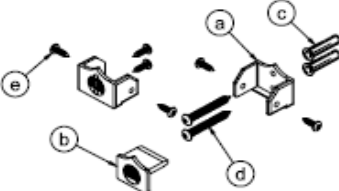
② Headrail Open End Kit	HDWT-A0461-OE	List Price	
	Includes:	\$ 21.00	
	a	HDWT-P0459 Headrail Bracket 1-1/4"	3
	b	HDWT-P0460 Headrail End Cap 1-1/4"	1
	c	FAST-T373 Plastic Anchor #14-16 x 3/8"	4
	d	FAST-P002 Screw #14 x 2" BTN	4
e	FAST-S351A Screw #10 x 5/8" BTN	14	

NOTE: Torx bits are not included but can be ordered separately.

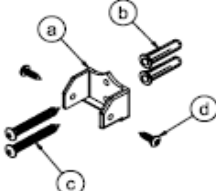
③ Headrail Between-the-Wall Kit	HDWT-A0461-BW	List Price	
	Includes:	\$ 13.00	
	a	HDWT-P0459 Headrail Bracket 1-1/4"	2
	b	FAST-T373 Plastic Anchor #14-16 x 3/8"	4
	c	FAST-P002 Screw #14 x 2" BTN	4
	d	FAST-S351A Screw #10 x 5/8" BTN	12

NOTE: Torx bits are not included but can be ordered separately.

Effective Date April 1, 2018

Shoe Kits

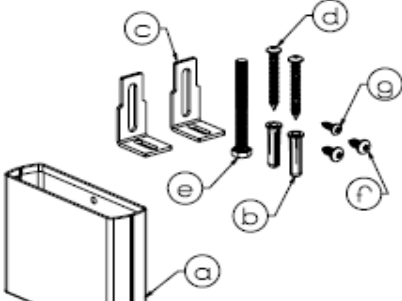
④ Shoe Kit (for Series 400)	Part No.	Description	Qty.	List Price
	HDWT-S0526-03	Actual Size 3"	1	\$ 38.00
	HDWT-S0526-04	Actual Size 4"	1	\$ 39.00
	HDWT-S0526-05	Actual Size 5"	1	\$ 40.00
	HDWT-S0526-06	Actual Size 6"	1	\$ 40.00
	HDWT-S0526-07	Actual Size 7"	1	\$ 41.00
	HDWT-S0526-08	Actual Size 8"	1	\$ 41.00
	HDWT-S0526-10	Actual Size 10"	1	\$ 42.00
	HDWT-S0526-12	Actual Size 12"	1	\$ 43.00
	HDWT-S0526-14	Actual Size 14"	1	\$ 44.00
	HDWT-S0526-18	Actual Size 18"	1	\$ 51.00
	HDWT-S0526-22	Actual Size 22"	1	\$ 57.00
	HDWT-S0526-24	Actual Size 24"	1	\$ 57.00

Includes Hardware:			
	Part No.	Description	Qty.
a	HDWT-S0524-XX	Pilaster Shoe (XX equals the shoe size)	1
b	FAST-T373	Plastic Anchor #14-16 X 1-3/8"	2
c	HDWT-S0525	Bracket-Leveling	2
d	FAST-P002	Screw 14X2 BTN SM TRX-T27 W/Pin 18-8 SS	2
e	FAST-S0039	Screw 5/16-18 X 3 Hex Cap SS	1
f	FAST-S355A	Screw 1/4-14X5/8 BTN T/S TRX-T27 W/Pin 410 SS NKLP	2
g	FAST-S351A	Screw #10X5/8 BTN T/S TRX-T27 W/Pin 410 SS NKLP	1

NOTE: Torx bits are not included but can be ordered separately.

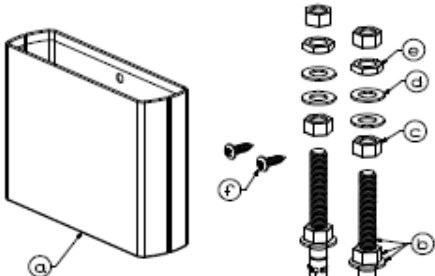
④ Shoe Kit (for Series 500)	Part No.	Description	Qty.	List Price
	HDWT-S0527-03	Actual Size 3"	1	\$ 49.00
	HDWT-S0527-04	Actual Size 4"	1	\$ 50.00
	HDWT-S0527-05	Actual Size 5"	1	\$ 51.00
	HDWT-S0527-06	Actual Size 6"	1	\$ 51.00
	HDWT-S0527-07	Actual Size 7"	1	\$ 52.00
	HDWT-S0527-08	Actual Size 8"	1	\$ 52.00
	HDWT-S0527-10	Actual Size 10"	1	\$ 53.00
	HDWT-S0527-12	Actual Size 12"	1	\$ 54.00
	HDWT-S0527-14	Actual Size 14"	1	\$ 55.00
	HDWT-S0527-18	Actual Size 18"	1	\$ 60.00
	HDWT-S0527-22	Actual Size 22"	1	\$ 66.00
	HDWT-S0527-24	Actual Size 24"	1	\$ 66.00

Includes Hardware:			
	Part No.	Description	Qty.
a	HDWT-S0524-XX	Pilaster Shoe (XX equals the shoe size)	1
b	FAST-S0040	Wedge Anchor 3/8-16 X 3-3/4 SS W/Nut & Washer	2
c	FAST-S0041	Nut 3/8 - 16 Hex 18-8 SS	4
d	FAST-S0042	Washer .406X.750X.050 Flat 18-8 SS	4
e	FAST-S0044	Spacer Nut 18-8 SS	2
f	FAST-S351A	Screw #10X5/8 BTN T/S TRX-T27 W/Pin 410 SS NKLP	2

NOTE: Torx bits are not included but can be ordered separately.

Effective Date April 1, 2018

Shoe Kits

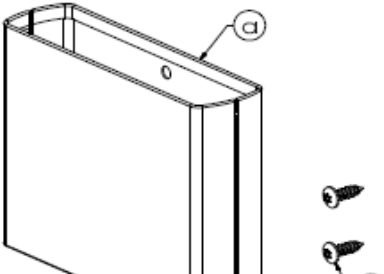
4 Shoe	Part No.	Description	Qty.	List Price
	HDWT-S0528-03	Actual Size 3"	1	\$ 6.00
	HDWT-S0528-04	Actual Size 4"	1	\$ 8.00
	HDWT-S0528-05	Actual Size 5"	1	\$ 10.00
	HDWT-S0528-06	Actual Size 6"	1	\$ 12.00
	HDWT-S0528-07	Actual Size 7"	1	\$ 12.00
	HDWT-S0528-08	Actual Size 8"	1	\$ 14.00
	HDWT-S0528-10	Actual Size 10"	1	\$ 18.00
	HDWT-S0528-12	Actual Size 12"	1	\$ 21.00
	HDWT-S0528-14	Actual Size 14"	1	\$ 24.00
	HDWT-S0528-18	Actual Size 18"	1	\$ 32.00
	HDWT-S0528-22	Actual Size 22"	1	\$ 41.00
	HDWT-S0528-24	Actual Size 24"	1	\$ 42.00

Includes Hardware:			
Part No.	Description	Qty.	
a	HDWT-S0524-XX	Pilaster Shoe (XX equals the shoe size)	1
b	FAST-S351A	Screw #10X5/8 BTN T/S TRX-T27 W/Pin 410 SS NKLP	2

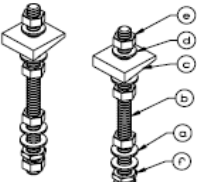
4 Ceiling Stud (for Series 600 Sleeve Kit)	HDWT-Z0455-2	List Price			
	Part No.	Description	Qty.	\$ 19.00	
	a	FAST-S0042	Washer .406 x .750 x .050 FLAT 18-8 SS	6	
	b	FAST-T5416	Threaded Rod 3/8 - 16 x 6 UNC-2A	2	
	c	FAST-T680	Washer 1-1/4 SQ x 3/8 Bevel 3/8 Screw Cast Iron	2	
	d	FAST-T377	Washer 3/8" Split-Lock Zamac P S	2	
	e	FAST-T375	Nut 3/8 - 16 Hex Zamac P S	8	
	f	FAST-S0044	Spacer Nut 18-8 SS	2	

NOTE: Torx bits are not included but can be ordered separately.

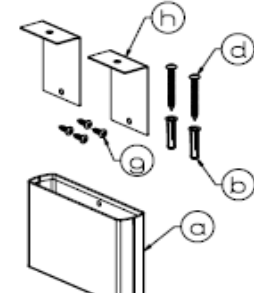
4 Shoe/Sleeve Kit (for Series 700)	Part No.	Description	Qty.	List Price
	HDWT-S0529-03	Actual Size 3"	1	\$ 63.00
	HDWT-S0529-04	Actual Size 4"	1	\$ 64.00
	HDWT-S0529-05	Actual Size 5"	1	\$ 65.00
	HDWT-S0529-06	Actual Size 6"	1	\$ 66.00
	HDWT-S0529-07	Actual Size 7"	1	\$ 67.00
	HDWT-S0529-08	Actual Size 8"	1	\$ 67.00
	HDWT-S0529-10	Actual Size 10"	1	\$ 70.00
	HDWT-S0529-12	Actual Size 12"	1	\$ 74.00
	HDWT-S0529-14	Actual Size 14"	1	\$ 83.00
	HDWT-S0529-18	Actual Size 18"	1	\$ 87.00
	HDWT-S0529-22	Actual Size 22"	1	\$ 87.00
	HDWT-S0529-24	Actual Size 24"	1	\$ 92.00

Includes Hardware:			
Part No.	Description	Qty.	
a	HDWT-S0524-XX	Pilaster Shoe (XX equals the shoe size)	2
b	FAST-T373	Plastic Anchor #14-16 X 1-3/8"	4
c	HDWT-S0525	Bracket-Leveling	2
d	FAST-P002	Screw 14X2 BTN SM TRX-T27 W/Pin 18-8 SS	4
e	FAST-S0039	Screw 5/16-18 X 3 Hex Cap SS	1
f	FAST-S355A	Screw 1/4-14X5/8 BTN T/S TRX-T27 W/Pin 410 SS NKLP	2
g	FAST-S351A	Screw #10X5/8 BTN T/S TRX-T27 W/Pin 410 SS NKLP	5
h	HDWT-T0440	Bracket "L" FTC	2

NOTE: Torx bits are not included but can be ordered separately.

Prices subject to change without notice.
Items may be changed or discontinued
without notice and without incurring obligation.

Effective Date April 1, 2018

Inswing Door Kits

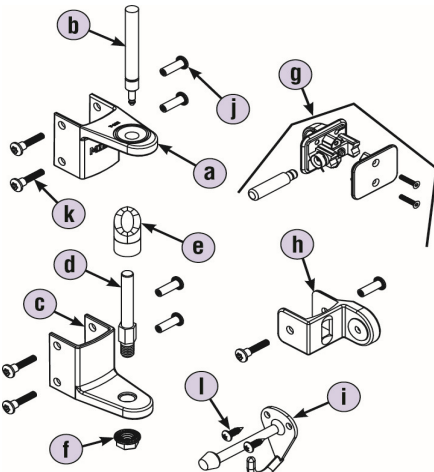
5 Inswing Door Kit	HDWT-ZD1	List Price			
	Includes:	\$ 63.00			
	<table border="1"> <thead> <tr> <th>Part No.</th> <th>Description</th> <th>Qty.</th> </tr> </thead> </table>	Part No.	Description	Qty.	
	Part No.	Description	Qty.		
	a HDWT-T101 Top Hinge w/Bushing	1			
	b HDWT-T103 Pin, Top Hinge	1			
	c HDWT-T112 Bottom Hinge	1			
	d HDWT-T113 Pin, Bottom Hinge	1			
	e HDWT-T211 Cam, Bottom Hinge	1			
	f HDWT-T118 3/8"-16 Lock Nut, Bottom Hinge	1			
	g HDWT-T290 Hardware Kit, Concealed Latch	1			
	h HDWT-Z0119 Wrap Around Strike Keeper	1			
	i HDWT-Z285 Coat Hook w/Bumper ZP	1			
	j FAST-Z003 Screw #10-24 x 3/4" Barrel-Female Torx-T27 w/Pin ZP	5			
k FAST-Z004A Screw #10-24 x 1" Step-Male Torx-T27 w/Pin ZP	5				
l FAST-Z0019 Screw #10 x 5/8" Sheet Metal Torx-T27 w/Pin ZP	2				
Also available in Stainless Steel - HDWT-SD1 NOTE: Torx bits are not included but can be ordered separately.		\$ 75.00			

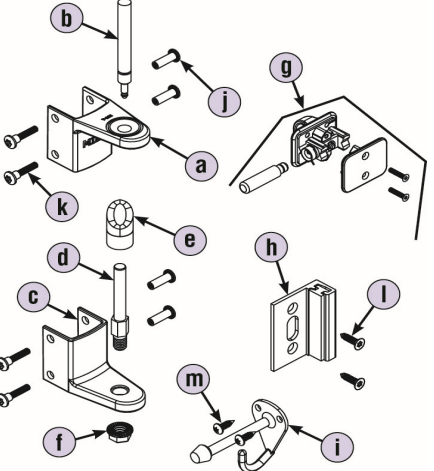
5 Inswing Door Kit with Flat Strike/Keeper	HDWT-ZD1-FS	List Price			
	Includes:	\$ 80.00			
	<table border="1"> <thead> <tr> <th>Part No.</th> <th>Description</th> <th>Qty.</th> </tr> </thead> </table>	Part No.	Description	Qty.	
	Part No.	Description	Qty.		
	a HDWT-T101 Top Hinge w/Bushing	1			
	b HDWT-T103 Pin, Top Hinge	1			
	c HDWT-T112 Bottom Hinge	1			
	d HDWT-T113 Pin, Bottom Hinge	1			
	e HDWT-T211 Cam, Bottom Hinge	1			
	f HDWT-T118 3/8"-16 Lock Nut, Bottom Hinge	1			
	g HDWT-T290 Hardware Kit, Concealed Latch	1			
	h HDWT-Z0022 Flat Strike/Keeper Inswing & Outswing	1			
	i HDWT-Z285 Coat Hook with Bumper	1			
	j FAST-Z003 Screw #10-24 x 3/4" Barrel-Female Torx-T27 w/Pin ZP	4			
k FAST-Z004A Screw #10-24 x 1" Step-Male Torx-T27 w/Pin ZP	4				
l FAST-Z0006 Screw #10 x 3/4" FL Sheet Metal Torx-T25 w/Pin ZP	2				
m FAST-Z0019 Screw #10 x 5/8" Sheet Metal Torx-T27 w/Pin ZP	2				
Also available in Stainless Steel - HDWT-SD1-FS NOTE: Torx bits are not included but can be ordered separately.		\$ 118.00			

Effective Date April 1, 2018

Inswing Door Kits

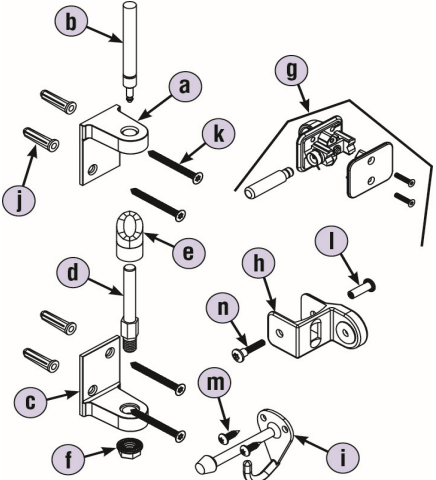
5 Inswing Door Kit with Flat Hinge	HDWT-ZD1-FH	List Price			
	Includes:	\$ 110.00			
	<table border="1"> <thead> <tr> <th>Part No.</th> <th>Description</th> <th>Qty.</th> </tr> </thead> </table>	Part No.	Description	Qty.	
	Part No.	Description	Qty.		
	a HDWT-S0149 Top Hinge Flat w/Bushing SS	1			
	b HDWT-T103 Pin, Top Hinge	1			
	c HDWT-S0150 Bottom Hinge Flat SS	1			
	d HDWT-T113 Pin, Bottom Hinge	1			
	e HDWT-T211 Cam, Bottom Hinge	1			
	f HDWT-T118 3/8"-16 Lock Nut, Bottom Hinge	1			
	g HDWT-T290 Hardware Kit, Concealed Latch	1			
	h HDWT-Z0119 Wrap Around Strike Keeper	1			
	i HDWT-Z285 Coat Hook with Bumper	1			
	j FAST-T381 Anchor - Plastic #10-12 x 1" Lg.	4			
	k FAST-S0023 Screw #10 x 2" FL Sheet Metal Torx-T25 w/Pin SS	4			
l FAST-Z003 Screw #10-24 x 3/4" Barrel-Female Torx-T27 w/Pin ZP	1				
m FAST-Z0019 Screw #10 x 5/8" Sheet Metal Torx-T27 w/Pin ZP	2				
n FAST-Z004A Screw #10-24 x 1" Step-Male Torx-T27 w/Pin ZP	1				
Also available in Stainless Steel - HDWT-SD1-FH	\$ 129.00				

NOTE: Torx bits are not included but can be ordered separately.

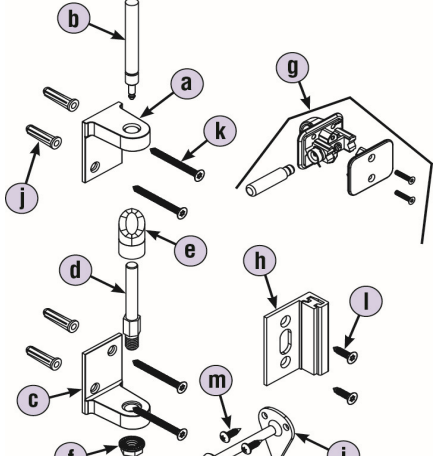
5 Inswing Door Kit with Flat Hinge & Strike/Keeper	HDWT-ZD1-FSH	List Price			
	Includes:	\$ 126.00			
	<table border="1"> <thead> <tr> <th>Part No.</th> <th>Description</th> <th>Qty.</th> </tr> </thead> </table>	Part No.	Description	Qty.	
	Part No.	Description	Qty.		
	a HDWT-S0149 Top Hinge Flat w/Bushing SS	1			
	b HDWT-T103 Pin, Top Hinge	1			
	c HDWT-S0150 Bottom Hinge Flat SS	1			
	d HDWT-T113 Pin, Bottom Hinge	1			
	e HDWT-T211 Cam, Bottom Hinge	1			
	f HDWT-T118 3/8"-16 Lock Nut, Bottom Hinge	1			
	g HDWT-T290 Hardware Kit, Concealed Latch	1			
	h HDWT-Z0022 Flat Strike/Keeper I/S & O/S	1			
	i HDWT-Z285 Coat Hook with Bumper	1			
	j FAST-T381 Anchor - Plastic #10-12 x 1" Lg.	4			
	k FAST-S0023 Screw #10 x 2" FL Sheet Metal Torx-T25 w/Pin SS	4			
l FAST-Z0006 Screw #10 x 3/4" FL Sheet Metal Torx-T25 w/Pin ZP	2				
m FAST-Z0019 Screw #10 x 5/8" Sheet Metal Torx-T27 w/Pin ZP	2				
Also available in Stainless Steel - HDWT-SD1-FSH	\$ 142.00				

NOTE: Torx bits are not included but can be ordered separately.

Effective Date April 1, 2018

Inswing Door Kits

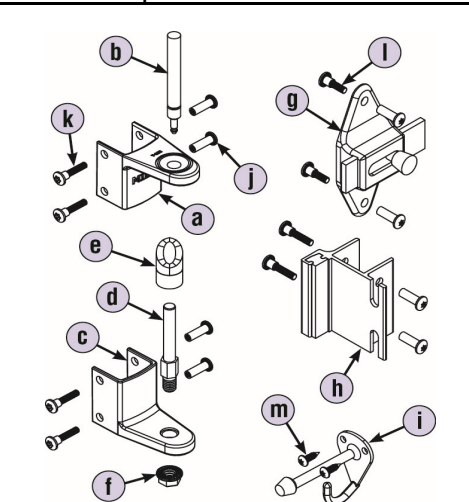
	HDWT-ZD1-SLWS			List Price
	Includes:			\$ 68.00
		Part No.	Description	Qty.
	a	HDWT-T101	Top Hinge w/Bushing	1
	b	HDWT-T103	Pin, Top Hinge	1
	c	HDWT-T112	Bottom Hinge	1
	d	HDWT-T113	Pin, Bottom Hinge	1
	e	HDWT-T211	Cam, Bottom Hinge	1
	f	HDWT-T118	3/8"-16 Lock Nut, Bottom Hinge	1
	g	HDWT-Z0124	Latch, Slide Surface Mount ZP	1
	h	HDWT-Z0125	Strike/Keeper Inswing ZP	1
i	HDWT-Z285	Coat Hook w/Bumper ZP	1	
j	FAST-Z003	Screw #10-24 x 3/4" Barrel-Female Torx-T27 w/Pin ZP	8	
k	FAST-Z004A	Screw #10-24 x 1" Step-Male Torx-T27 w/Pin ZP	6	
l	FAST-Z004	Screw #10-24 x 3/4" Step-Male Torx-T27 ZP	2	
m	FAST-Z0019	Screw #10 x 5/8" Sheet Metal Torx-T27 w/Pin ZP	2	
Also available in Stainless Steel - HDWT-SD1-SLWS				\$ 122.00
NOTE: Torx bits are not included but can be ordered separately.				

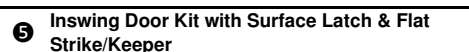
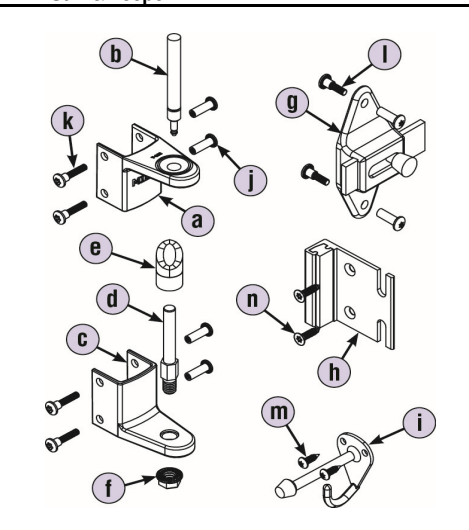
	HDWT-ZD1-SLFS			List Price
	Includes:			\$ 58.00
		Part No.	Description	Qty.
	a	HDWT-T101	Top Hinge w/Bushing	1
	b	HDWT-T103	Pin, Top Hinge	1
	c	HDWT-T112	Bottom Hinge	1
	d	HDWT-T113	Pin, Bottom Hinge	1
	e	HDWT-T211	Cam, Bottom Hinge	1
	f	HDWT-T118	3/8"-16 Lock Nut, Bottom Hinge	1
	g	HDWT-Z0124	Latch, Slide Surface Mount ZP	1
	h	HDWT-Z0127	Flat Strike/Keeper Inswing ZP	1
i	HDWT-Z285	Coat Hook with Bumper	1	
j	FAST-Z003	Screw #10-24 x 3/4" Barrel-Female Torx-T27 w/Pin ZP	6	
k	FAST-Z004A	Screw #10-24 x 1" Step-Male Torx-T27 w/Pin ZP	4	
l	FAST-Z004	Screw #10-24 x 3/4" Step-Male Torx-T27 ZP	2	
m	FAST-Z0019	Screw #10 x 5/8" Sheet Metal Torx-T27 w/Pin ZP	2	
n	FAST-Z0006	Screw #10 x 3/4" FL Sheet Metal Torx-T25 w/Pin ZP	2	
Also available in Stainless Steel - HDWT-SD1-SLFS				\$ 120.00
NOTE: Torx bits are not included but can be ordered separately.				

Effective Date April 1, 2018

Inswing Door Kits

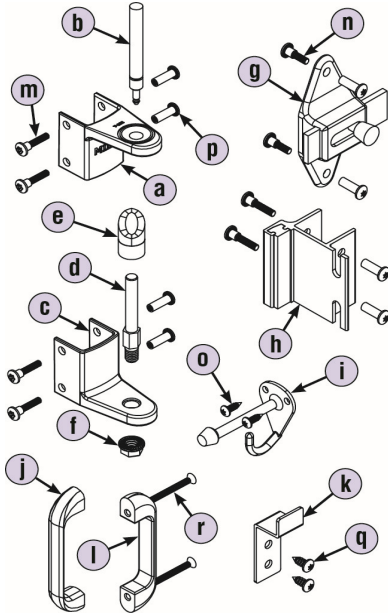
**5 Inswing ADA Door Kit with Surface Latch
W/A Strike/Keeper & Door Pull**

HDWT-ZD1-SLWSHC			List Price
Includes:			\$ 77.00
Part No.	Description	Qty.	
a	HDWT-T101 Top Hinge w/Bushing	1	
b	HDWT-T103 Pin, Top Hinge	1	
c	HDWT-T112 Bottom Hinge	1	
d	HDWT-T113 Pin, Bottom Hinge	1	
e	HDWT-T211 Cam, Bottom Hinge	1	
f	HDWT-T118 3/8"-16 Lock Nut, Bottom Hinge	1	
g	HDWT-Z0124 Latch, Slide Surface Mount ZP	1	
h	HDWT-Z0125 Strike/Keeper Inswing ZP	1	
i	HDWT-Z285 Coat Hook w/Bumper ZP	1	
j	HDWT-Z282 Door Pull ZP	1	
k	HDWT-S275 Coat Hook Outswing Stainless Steel	1	
l	HDW0-Z0167 Door Pull with Countersink	1	
m	FAST-Z004A Screw #10-24 x 1" Step-Male Torx-T27 w/Pin ZP	6	
n	FAST-Z004 Screw #10-24 x 3/4" Step-Male Torx-T27 ZP	2	
o	FAST-Z0019 Screw #10 x 5/8" Sheet Metal Torx-T27 w/Pin ZP	2	
p	FAST-Z003 Screw #10-24 x 3/4" Barrel-Female Torx-T27 w/Pin ZP	8	
q	FAST-Z0016 Screw #14 x 5/8" Sheet Metal Torx-T27 w/Pin ZP	2	
r	FAST-Z0027 Screw #10-24 x 2" Flat Machine Torx ZP	2	
Also available in Stainless Steel - HDWT-SD1-SLWSHC			\$ 162.00

NOTE: Torx bits are not included but can be ordered separately.

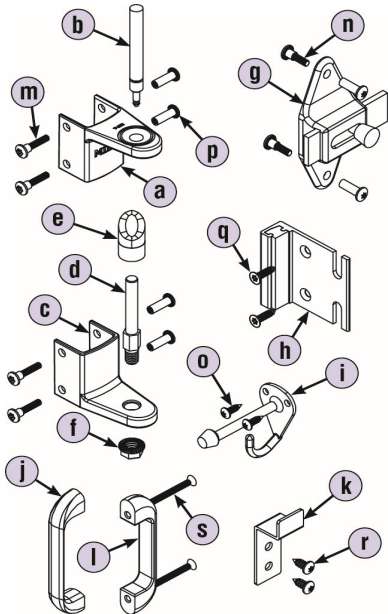
**5 Inswing ADA Door Kit with Surface Latch,
Flat Strike/Keeper & Door Pull**

HDWT-ZD1-SLFSHC			List Price
Includes:			\$ 65.00
Part No.	Description	Qty.	
a	HDWT-T101 Top Hinge w/Bushing	1	
b	HDWT-T103 Pin, Top Hinge	1	
c	HDWT-T112 Bottom Hinge	1	
d	HDWT-T113 Pin, Bottom Hinge	1	
e	HDWT-T211 Cam, Bottom Hinge	1	
f	HDWT-T118 3/8"-16 Lock Nut, Bottom Hinge	1	
g	HDWT-Z0124 Latch, Slide Surface Mount ZP	1	
h	HDWT-Z0127 Flat Strike/Keeper Inswing ZP	1	
i	HDWT-Z285 Coat Hook with Bumper	1	
j	HDWT-Z282 Door Pull ZP	1	
k	HDWT-S275 Coat Hook Outswing Stainless Steel	1	
l	HDW0-Z0167 Door Pull with Countersink	1	
m	FAST-Z004A Screw #10-24 x 1" Step-Male Torx-T27 w/Pin ZP	4	
n	FAST-Z004 Screw #10-24 x 3/4" Step-Male Torx-T27 ZP	2	
o	FAST-Z0019 Screw #10 x 5/8" Sheet Metal Torx-T27 w/Pin ZP	2	
p	FAST-Z003 Screw #10-24 x 3/4" Barrel-Female Torx-T27 w/Pin ZP	6	
q	FAST-Z0006 Screw #10 x 3/4" FL Sheet Metal Torx-T25 w/Pin ZP	2	
r	FAST-Z0016 Screw #14 x 5/8" Sheet Metal Torx-T27 w/Pin ZP	2	
s	FAST-Z0027 Screw #10-24 x 2" Flat Machine Torx ZP	2	
Also available in Stainless Steel - HDWT-SD1-SLFSHC			\$ 160.00

NOTE: Torx bits are not included but can be ordered separately.

Effective Date April 1, 2018

Inswing Door Kits

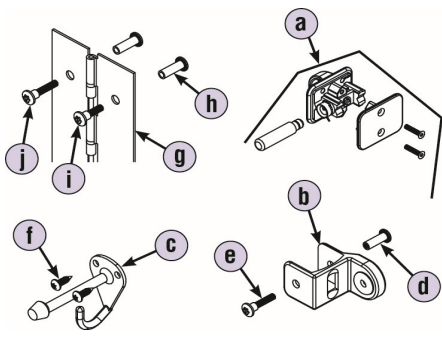
	5 Inswing Door Kit with Piano Hinge (RHI/LHO) HDWT-Z0234			List Price
	Includes:			\$ 180.00
	Part No.	Description	Qty.	
	a	HDWT-T290 Hardware Kit, Concealed Latch	1	
	b	HDWT-Z0119 Wrap Around Strike Keeper	1	
	c	HDWT-Z285 Coat Hook w/Bumper ZP	1	
	d	FAST-Z003 Screw #10-24 x 3/4" Barrel-Female Torx-T27 w/Pin ZP	1	
	e	FAST-Z004A Screw #10-24 x 1" Step-Male Torx-T27 w/Pin ZP	1	
	f	FAST-Z0019 Screw #10 x 5/8" Sheet Metal Torx-T27 w/Pin ZP	2	
	g	HDWT-S0208 Piano Hinge, Continuous Stainless Steel (RHI-LHO)	1	
	h	FAST-P003 Screw #10-24 x 3/4" BTN Barrel-Female Torx-T27 w/Pin SS	14	
	i	FAST-P004 Screw #10-24 x 3/4" BTN Step-Male Torx-T27 SS	7	
	j	FAST-P004A Screw #10-24 x 1" Shoulder Torx-T27 SS	7	
Also available in Stainless Steel - HDWT-S0234				\$ 203.00

NOTE: Torx bits are not included but can be ordered separately.

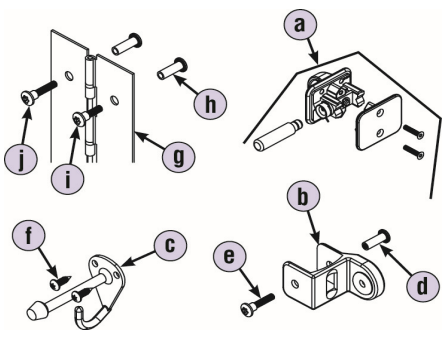
	5 Inswing Door Kit with Piano Hinge (LHI/RHO) HDWT-Z0236			List Price
	Includes:			\$ 180.00
	Part No.	Description	Qty.	
	a	HDWT-T290 Hardware Kit, Concealed Latch	1	
	b	HDWT-Z0119 Wrap Around Strike Keeper	1	
	c	HDWT-Z285 Coat Hook w/Bumper ZP	1	
	d	FAST-Z003 Screw #10-24 x 3/4" Barrel-Female Torx-T27 w/Pin ZP	1	
	e	FAST-Z004A Screw #10-24 x 1" Step-Male Torx-T27 w/Pin ZP	1	
	f	FAST-Z0019 Screw #10 x 5/8" Sheet Metal Torx-T27 w/Pin ZP	2	
	g	HDWT-S0209 Piano Hinge, Continuous Stainless Steel (LHI-RHO)	1	
	h	FAST-P003 Screw #10-24 x 3/4" BTN Barrel-Female Torx-T27 w/Pin SS	14	
	i	FAST-P004 Screw #10-24 x 3/4" BTN Step-Male Torx-T27 SS	7	
	j	FAST-P004A Screw #10-24 x 1" Shoulder Torx-T27 SS	7	
Also available in Stainless Steel - HDWT-S0236				\$ 203.00

NOTE: Torx bits are not included but can be ordered separately.

Effective Date April 1, 2018

Inswing Door Kits

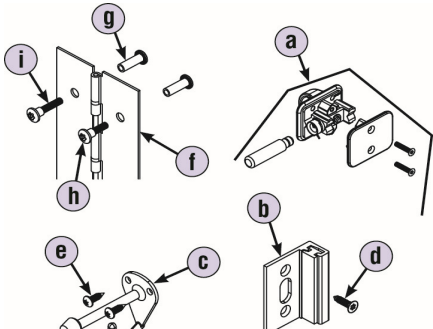
5 Inswing Flat Strike Door Kit with Piano Hinge (RHI/LHO)	HDWT-Z0238	List Price																																							
	Includes:	\$ 180.00																																							
	<table border="1"> <thead> <tr> <th>Part No.</th> <th>Description</th> <th>Qty.</th> </tr> </thead> <tbody> <tr> <td>a</td> <td>HDWT-T290</td> <td>Hardware Kit, Concealed Latch</td> <td>1</td> </tr> <tr> <td>b</td> <td>HDWT-Z0022</td> <td>Flat Strike Keeper</td> <td>1</td> </tr> <tr> <td>c</td> <td>HDWT-Z285</td> <td>Coat Hook w/Bumper ZP</td> <td>1</td> </tr> <tr> <td>d</td> <td>FAST-Z0006</td> <td>Screw #10 x 3/4" FL Sheet Metal Torx-T25 w/Pin ZP</td> <td>2</td> </tr> <tr> <td>e</td> <td>FAST-Z0019</td> <td>Screw #10 x 5/8" Sheet Metal Torx-T27 w/Pin ZP</td> <td>2</td> </tr> <tr> <td>f</td> <td>HDWT-S0208</td> <td>Piano Hinge, Continuous Stainless Steel (RHI-LHO)</td> <td>1</td> </tr> <tr> <td>g</td> <td>FAST-P003</td> <td>Screw #10-24 x 3/4" BTN Barrel-Female Torx-T27 w/Pin SS</td> <td>14</td> </tr> <tr> <td>h</td> <td>FAST-P004</td> <td>Screw #10-24 x 3/4" BTN Step-Male Torx-T27 SS</td> <td>7</td> </tr> <tr> <td>i</td> <td>FAST-P004A</td> <td>Screw #10-24 x 1" Shoulder Torx-T27 SS</td> <td>7</td> </tr> </tbody> </table>	Part No.	Description	Qty.	a	HDWT-T290	Hardware Kit, Concealed Latch	1	b	HDWT-Z0022	Flat Strike Keeper	1	c	HDWT-Z285	Coat Hook w/Bumper ZP	1	d	FAST-Z0006	Screw #10 x 3/4" FL Sheet Metal Torx-T25 w/Pin ZP	2	e	FAST-Z0019	Screw #10 x 5/8" Sheet Metal Torx-T27 w/Pin ZP	2	f	HDWT-S0208	Piano Hinge, Continuous Stainless Steel (RHI-LHO)	1	g	FAST-P003	Screw #10-24 x 3/4" BTN Barrel-Female Torx-T27 w/Pin SS	14	h	FAST-P004	Screw #10-24 x 3/4" BTN Step-Male Torx-T27 SS	7	i	FAST-P004A	Screw #10-24 x 1" Shoulder Torx-T27 SS	7	
	Part No.	Description	Qty.																																						
	a	HDWT-T290	Hardware Kit, Concealed Latch	1																																					
	b	HDWT-Z0022	Flat Strike Keeper	1																																					
	c	HDWT-Z285	Coat Hook w/Bumper ZP	1																																					
	d	FAST-Z0006	Screw #10 x 3/4" FL Sheet Metal Torx-T25 w/Pin ZP	2																																					
	e	FAST-Z0019	Screw #10 x 5/8" Sheet Metal Torx-T27 w/Pin ZP	2																																					
	f	HDWT-S0208	Piano Hinge, Continuous Stainless Steel (RHI-LHO)	1																																					
	g	FAST-P003	Screw #10-24 x 3/4" BTN Barrel-Female Torx-T27 w/Pin SS	14																																					
h	FAST-P004	Screw #10-24 x 3/4" BTN Step-Male Torx-T27 SS	7																																						
i	FAST-P004A	Screw #10-24 x 1" Shoulder Torx-T27 SS	7																																						
Also available in Stainless Steel - HDWT-S0238	\$ 203.00																																								

NOTE: Torx bits are not included but can be ordered separately.

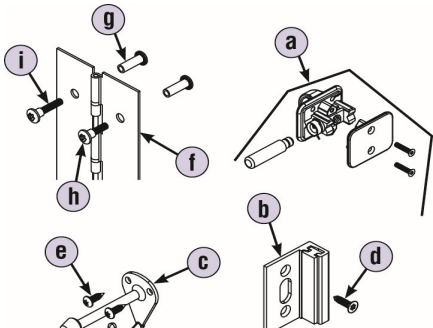
5 Inswing Flat Strike Door Kit with Piano Hinge (LHI/RHO)	HDWT-Z0240	List Price																																							
	Includes:	\$ 180.00																																							
	<table border="1"> <thead> <tr> <th>Part No.</th> <th>Description</th> <th>Qty.</th> </tr> </thead> <tbody> <tr> <td>a</td> <td>HDWT-T290</td> <td>Hardware Kit, Concealed Latch</td> <td>1</td> </tr> <tr> <td>b</td> <td>HDWT-Z0022</td> <td>Flat Strike Keeper</td> <td>1</td> </tr> <tr> <td>c</td> <td>HDWT-Z285</td> <td>Coat Hook w/Bumper ZP</td> <td>1</td> </tr> <tr> <td>d</td> <td>FAST-Z0006</td> <td>Screw #10 x 3/4" FL Sheet Metal Torx-T25 w/Pin ZP</td> <td>2</td> </tr> <tr> <td>e</td> <td>FAST-Z0019</td> <td>Screw #10 x 5/8" Sheet Metal Torx-T27 w/Pin ZP</td> <td>2</td> </tr> <tr> <td>f</td> <td>HDWT-S0209</td> <td>Piano Hinge, Continuous Stainless Steel (LHI-RHO)</td> <td>1</td> </tr> <tr> <td>g</td> <td>FAST-P003</td> <td>Screw #10-24 x 3/4" BTN Barrel-Female Torx-T27 w/Pin SS</td> <td>14</td> </tr> <tr> <td>h</td> <td>FAST-P004</td> <td>Screw #10-24 x 3/4" BTN Step-Male Torx-T27 SS</td> <td>7</td> </tr> <tr> <td>i</td> <td>FAST-P004A</td> <td>Screw #10-24 x 1" Shoulder Torx-T27 SS</td> <td>7</td> </tr> </tbody> </table>	Part No.	Description	Qty.	a	HDWT-T290	Hardware Kit, Concealed Latch	1	b	HDWT-Z0022	Flat Strike Keeper	1	c	HDWT-Z285	Coat Hook w/Bumper ZP	1	d	FAST-Z0006	Screw #10 x 3/4" FL Sheet Metal Torx-T25 w/Pin ZP	2	e	FAST-Z0019	Screw #10 x 5/8" Sheet Metal Torx-T27 w/Pin ZP	2	f	HDWT-S0209	Piano Hinge, Continuous Stainless Steel (LHI-RHO)	1	g	FAST-P003	Screw #10-24 x 3/4" BTN Barrel-Female Torx-T27 w/Pin SS	14	h	FAST-P004	Screw #10-24 x 3/4" BTN Step-Male Torx-T27 SS	7	i	FAST-P004A	Screw #10-24 x 1" Shoulder Torx-T27 SS	7	
	Part No.	Description	Qty.																																						
	a	HDWT-T290	Hardware Kit, Concealed Latch	1																																					
	b	HDWT-Z0022	Flat Strike Keeper	1																																					
	c	HDWT-Z285	Coat Hook w/Bumper ZP	1																																					
	d	FAST-Z0006	Screw #10 x 3/4" FL Sheet Metal Torx-T25 w/Pin ZP	2																																					
	e	FAST-Z0019	Screw #10 x 5/8" Sheet Metal Torx-T27 w/Pin ZP	2																																					
	f	HDWT-S0209	Piano Hinge, Continuous Stainless Steel (LHI-RHO)	1																																					
	g	FAST-P003	Screw #10-24 x 3/4" BTN Barrel-Female Torx-T27 w/Pin SS	14																																					
h	FAST-P004	Screw #10-24 x 3/4" BTN Step-Male Torx-T27 SS	7																																						
i	FAST-P004A	Screw #10-24 x 1" Shoulder Torx-T27 SS	7																																						
Also available in Stainless Steel - HDWT-S0240	\$ 203.00																																								

NOTE: Torx bits are not included but can be ordered separately.

Effective Date April 1, 2018

Outswing Door Kits

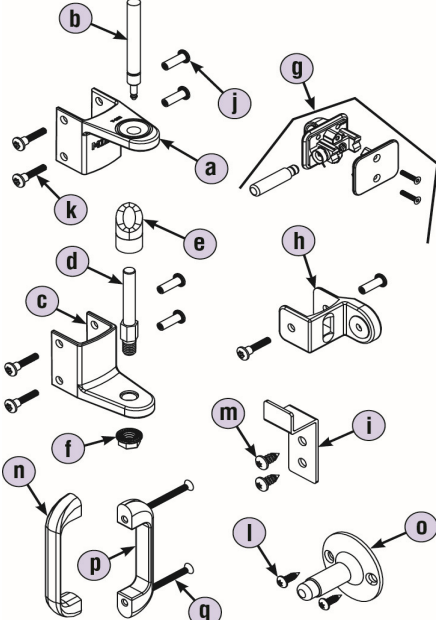
6 Outswing Door Kit	HDWT-ZD2	List Price			
	Includes:	\$ 80.00			
	<table border="1"> <thead> <tr> <th>Part No.</th> <th>Description</th> <th>Qty.</th> </tr> </thead> </table>	Part No.	Description	Qty.	
	Part No.	Description	Qty.		
	a HDWT-T101 Top Hinge w/Bushing	1			
	b HDWT-T103 Pin, Top Hinge	1			
	c HDWT-T112 Bottom Hinge	1			
	d HDWT-T113 Pin, Bottom Hinge	1			
	e HDWT-T211 Cam, Bottom Hinge	1			
	f HDWT-T118 3/8"-16 Lock Nut, Bottom Hinge	1			
	g HDWT-T290 Hardware Kit, Concealed Latch	1			
	h HDWT-Z0119 Wrap Around Strike Keeper	1			
	i HDWT-S275 Coat Hook Outswing Stainless Steel	1			
	j FAST-Z003 Screw #10-24 x 3/4" Barrel-Female Torx-T27 w/Pin ZP	5			
	k FAST-Z004A Screw #10-24 x 1" Step-Male Torx-T27 w/Pin ZP	5			
	l FAST-Z0019 Screw #10 x 5/8" Sheet Metal Torx-T27 w/Pin ZP	2			
m FAST-Z0016 Screw #14 x 5/8" Sheet Metal Torx-T27 w/Pin ZP	2				
n HDWT-Z282 Door Pull ZP	1				
o HDWT-Z177 Wall Bumper	1				
p HDW0-Z0167 Door Pull with Countersink	1				
q FAST-Z0027 Screw #10-24 x 2" Flat Machine Torx ZP	2				
Also available in Stainless Steel - HDWT-SD2		\$ 101.00			
NOTE: Torx bits are not included but can be ordered separately.					

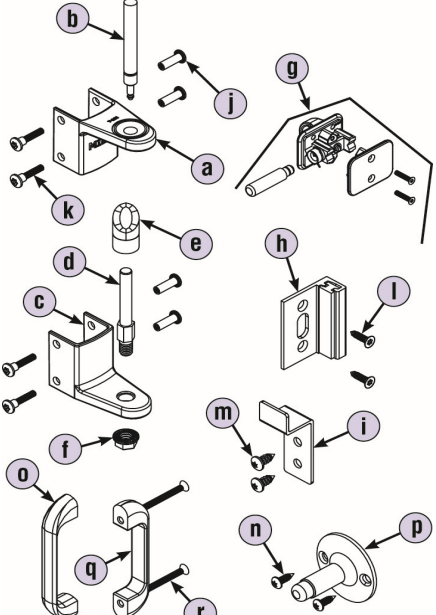
6 Outswing Door Kit with Flat Strike/Keeper	HDWT-ZD2-FS	List Price			
	Includes:	\$ 98.00			
	<table border="1"> <thead> <tr> <th>Part No.</th> <th>Description</th> <th>Qty.</th> </tr> </thead> </table>	Part No.	Description	Qty.	
	Part No.	Description	Qty.		
	a HDWT-T101 Top Hinge w/Bushing	1			
	b HDWT-T103 Pin, Top Hinge	1			
	c HDWT-T112 Bottom Hinge	1			
	d HDWT-T113 Pin, Bottom Hinge	1			
	e HDWT-T211 Cam, Bottom Hinge	1			
	f HDWT-T118 3/8"-16 Lock Nut, Bottom Hinge	1			
	g HDWT-T290 Hardware Kit, Concealed Latch	1			
	h HDWT-Z0022 Flat Strike Keeper	1			
	i HDWT-S275 Coat Hook Outswing Stainless Steel	1			
	j FAST-Z003 Screw #10-24 x 3/4" Barrel-Female Torx-T27 w/Pin ZP	4			
	k FAST-Z004A Screw #10-24 x 1" Step-Male Torx-T27 w/Pin ZP	4			
	l FAST-Z0006 Screw #10 x 3/4" FL Sheet Metal Torx-T25 w/Pin ZP	2			
m FAST-Z0016 Screw #14 x 5/8" Sheet Metal Torx-T27 w/Pin ZP	2				
n FAST-Z0019 Screw #10 x 5/8" Sheet Metal Torx-T27 w/Pin ZP	2				
o HDWT-Z282 Door Pull ZP	1				
p HDWT-Z177 Wall Bumper	1				
q HDW0-Z0167 Door Pull with Countersink	1				
r FAST-Z0027 Screw #10-24 x 2" Flat Machine Torx ZP	2				
Also available in Stainless Steel - HDWT-SD2-FS		\$ 176.00			
NOTE: Torx bits are not included but can be ordered separately.					

Prices subject to change without notice.
Items may be changed or discontinued
without notice and without incurring obligation.

Effective Date April 1, 2018

Outswing Door Kits

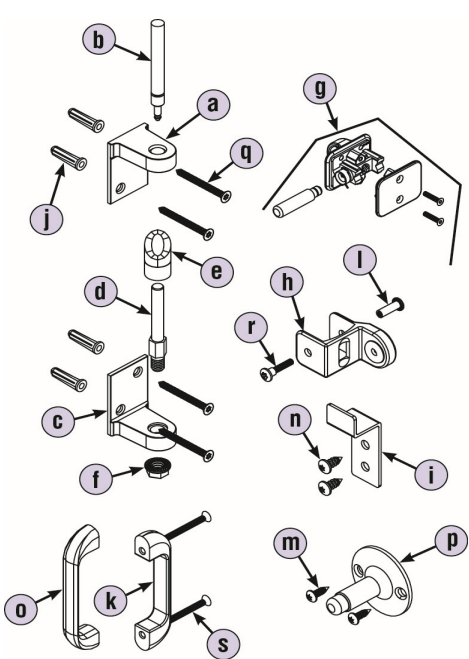
6 Outswing Door Kit with Flat Hinge	HDWT-ZD2-FH	List Price																																																												
	Includes:	\$ 132.00																																																												
	<table border="1"> <thead> <tr> <th>Part No.</th> <th>Description</th> <th>Qty.</th> </tr> </thead> <tbody> <tr> <td>a</td> <td>HDWT-S0149 Top Hinge Flat w/Bushing SS</td> <td>1</td> </tr> <tr> <td>b</td> <td>HDWT-T103 Pin, Top Hinge</td> <td>1</td> </tr> <tr> <td>c</td> <td>HDWT-S0150 Bottom Hinge Flat SS</td> <td>1</td> </tr> <tr> <td>d</td> <td>HDWT-T113 Pin, Bottom Hinge</td> <td>1</td> </tr> <tr> <td>e</td> <td>HDWT-T211 Cam, Bottom Hinge</td> <td>1</td> </tr> <tr> <td>f</td> <td>HDWT-T118 3/8"-16 Lock Nut, Bottom Hinge</td> <td>1</td> </tr> <tr> <td>g</td> <td>HDWT-T290 Hardware Kit, Concealed Latch</td> <td>1</td> </tr> <tr> <td>h</td> <td>HDWT-Z0119 Wrap Around Strike Keeper</td> <td>1</td> </tr> <tr> <td>i</td> <td>HDWT-S275 Coat Hook Outswing Stainless Steel</td> <td>1</td> </tr> <tr> <td>j</td> <td>FAST-T381 Anchor - Plastic #10-12 x 1" Lg.</td> <td>4</td> </tr> <tr> <td>k</td> <td>HDW0-Z0167 Door Pull with Countersink</td> <td>1</td> </tr> <tr> <td>l</td> <td>FAST-Z003 Screw #10-24 x 3/4" Barrel-Female Torx-T27 w/Pin ZP</td> <td>1</td> </tr> <tr> <td>m</td> <td>FAST-Z0019 Screw #10 x 5/8" Sheet Metal Torx-T27 w/Pin ZP</td> <td>2</td> </tr> <tr> <td>n</td> <td>FAST-Z0016 Screw #14 x 5/8" Sheet Metal Torx-T27 w/Pin ZP</td> <td>2</td> </tr> <tr> <td>o</td> <td>HDWT-Z282 Door Pull ZP</td> <td>1</td> </tr> <tr> <td>p</td> <td>HDWT-Z177 Wall Bumper</td> <td>1</td> </tr> <tr> <td>q</td> <td>FAST-S0023 Screw #10 x 2" FL Sheet Metal Torx-T25 w/Pin SS</td> <td>4</td> </tr> <tr> <td>r</td> <td>FAST-Z004A Screw #10-24 x 1" Step-Male Torx-T27 w/Pin ZP</td> <td>1</td> </tr> <tr> <td>s</td> <td>FAST-Z0027 Screw #10-24 x 2" Flat Machine Torx ZP</td> <td>2</td> </tr> </tbody> </table>	Part No.	Description	Qty.	a	HDWT-S0149 Top Hinge Flat w/Bushing SS	1	b	HDWT-T103 Pin, Top Hinge	1	c	HDWT-S0150 Bottom Hinge Flat SS	1	d	HDWT-T113 Pin, Bottom Hinge	1	e	HDWT-T211 Cam, Bottom Hinge	1	f	HDWT-T118 3/8"-16 Lock Nut, Bottom Hinge	1	g	HDWT-T290 Hardware Kit, Concealed Latch	1	h	HDWT-Z0119 Wrap Around Strike Keeper	1	i	HDWT-S275 Coat Hook Outswing Stainless Steel	1	j	FAST-T381 Anchor - Plastic #10-12 x 1" Lg.	4	k	HDW0-Z0167 Door Pull with Countersink	1	l	FAST-Z003 Screw #10-24 x 3/4" Barrel-Female Torx-T27 w/Pin ZP	1	m	FAST-Z0019 Screw #10 x 5/8" Sheet Metal Torx-T27 w/Pin ZP	2	n	FAST-Z0016 Screw #14 x 5/8" Sheet Metal Torx-T27 w/Pin ZP	2	o	HDWT-Z282 Door Pull ZP	1	p	HDWT-Z177 Wall Bumper	1	q	FAST-S0023 Screw #10 x 2" FL Sheet Metal Torx-T25 w/Pin SS	4	r	FAST-Z004A Screw #10-24 x 1" Step-Male Torx-T27 w/Pin ZP	1	s	FAST-Z0027 Screw #10-24 x 2" Flat Machine Torx ZP	2	
	Part No.	Description	Qty.																																																											
	a	HDWT-S0149 Top Hinge Flat w/Bushing SS	1																																																											
	b	HDWT-T103 Pin, Top Hinge	1																																																											
	c	HDWT-S0150 Bottom Hinge Flat SS	1																																																											
	d	HDWT-T113 Pin, Bottom Hinge	1																																																											
	e	HDWT-T211 Cam, Bottom Hinge	1																																																											
	f	HDWT-T118 3/8"-16 Lock Nut, Bottom Hinge	1																																																											
	g	HDWT-T290 Hardware Kit, Concealed Latch	1																																																											
	h	HDWT-Z0119 Wrap Around Strike Keeper	1																																																											
	i	HDWT-S275 Coat Hook Outswing Stainless Steel	1																																																											
	j	FAST-T381 Anchor - Plastic #10-12 x 1" Lg.	4																																																											
	k	HDW0-Z0167 Door Pull with Countersink	1																																																											
	l	FAST-Z003 Screw #10-24 x 3/4" Barrel-Female Torx-T27 w/Pin ZP	1																																																											
	m	FAST-Z0019 Screw #10 x 5/8" Sheet Metal Torx-T27 w/Pin ZP	2																																																											
	n	FAST-Z0016 Screw #14 x 5/8" Sheet Metal Torx-T27 w/Pin ZP	2																																																											
o	HDWT-Z282 Door Pull ZP	1																																																												
p	HDWT-Z177 Wall Bumper	1																																																												
q	FAST-S0023 Screw #10 x 2" FL Sheet Metal Torx-T25 w/Pin SS	4																																																												
r	FAST-Z004A Screw #10-24 x 1" Step-Male Torx-T27 w/Pin ZP	1																																																												
s	FAST-Z0027 Screw #10-24 x 2" Flat Machine Torx ZP	2																																																												
Also available in Stainless Steel - HDWT-SD2-FH	\$ 189.00																																																													
NOTE: Torx bits are not included but can be ordered separately.																																																														

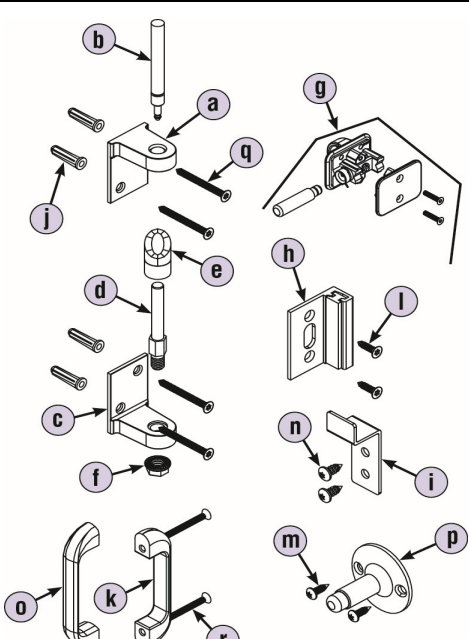
6 Outswing Door Kit with Flat Hinge & Strike/Keeper	HDWT-ZD2-FSH	List Price																																																									
	Includes:	\$ 150.00																																																									
	<table border="1"> <thead> <tr> <th>Part No.</th> <th>Description</th> <th>Qty.</th> </tr> </thead> <tbody> <tr> <td>a</td> <td>HDWT-S0149 Top Hinge Flat w/Bushing SS</td> <td>1</td> </tr> <tr> <td>b</td> <td>HDWT-T103 Pin, Top Hinge</td> <td>1</td> </tr> <tr> <td>c</td> <td>HDWT-S0150 Bottom Hinge Flat SS</td> <td>1</td> </tr> <tr> <td>d</td> <td>HDWT-T113 Pin, Bottom Hinge</td> <td>1</td> </tr> <tr> <td>e</td> <td>HDWT-T211 Cam, Bottom Hinge</td> <td>1</td> </tr> <tr> <td>f</td> <td>HDWT-T118 3/8"-16 Lock Nut, Bottom Hinge</td> <td>1</td> </tr> <tr> <td>g</td> <td>HDWT-T290 Hardware Kit, Concealed Latch</td> <td>1</td> </tr> <tr> <td>h</td> <td>HDWT-Z0022 Flat Strike/Keeper I/S & O/S</td> <td>1</td> </tr> <tr> <td>i</td> <td>HDWT-S275 Coat Hook Outswing Stainless Steel</td> <td>1</td> </tr> <tr> <td>j</td> <td>FAST-T381 Anchor - Plastic #10-12 x 1" Lg.</td> <td>4</td> </tr> <tr> <td>k</td> <td>HDW0-Z0167 Door Pull with Countersink</td> <td>1</td> </tr> <tr> <td>l</td> <td>FAST-Z0006 Screw #10 x 3/4" FL Sheet Metal Torx-T25 w/Pin ZP</td> <td>2</td> </tr> <tr> <td>m</td> <td>FAST-Z0019 Screw #10 x 5/8" Sheet Metal Torx-T27 w/Pin ZP</td> <td>2</td> </tr> <tr> <td>n</td> <td>FAST-Z0016 Screw #14 x 5/8" Sheet Metal Torx-T27 w/Pin ZP</td> <td>2</td> </tr> <tr> <td>o</td> <td>HDWT-Z282 Door Pull ZP</td> <td>1</td> </tr> <tr> <td>p</td> <td>HDWT-Z177 Wall Bumper</td> <td>1</td> </tr> <tr> <td>q</td> <td>FAST-S0023 Screw #10 x 2" FL Sheet Metal Torx-T25 w/Pin SS</td> <td>4</td> </tr> <tr> <td>r</td> <td>FAST-Z0027 Screw #10-24 x 2" Flat Machine Torx ZP</td> <td>2</td> </tr> </tbody> </table>	Part No.	Description	Qty.	a	HDWT-S0149 Top Hinge Flat w/Bushing SS	1	b	HDWT-T103 Pin, Top Hinge	1	c	HDWT-S0150 Bottom Hinge Flat SS	1	d	HDWT-T113 Pin, Bottom Hinge	1	e	HDWT-T211 Cam, Bottom Hinge	1	f	HDWT-T118 3/8"-16 Lock Nut, Bottom Hinge	1	g	HDWT-T290 Hardware Kit, Concealed Latch	1	h	HDWT-Z0022 Flat Strike/Keeper I/S & O/S	1	i	HDWT-S275 Coat Hook Outswing Stainless Steel	1	j	FAST-T381 Anchor - Plastic #10-12 x 1" Lg.	4	k	HDW0-Z0167 Door Pull with Countersink	1	l	FAST-Z0006 Screw #10 x 3/4" FL Sheet Metal Torx-T25 w/Pin ZP	2	m	FAST-Z0019 Screw #10 x 5/8" Sheet Metal Torx-T27 w/Pin ZP	2	n	FAST-Z0016 Screw #14 x 5/8" Sheet Metal Torx-T27 w/Pin ZP	2	o	HDWT-Z282 Door Pull ZP	1	p	HDWT-Z177 Wall Bumper	1	q	FAST-S0023 Screw #10 x 2" FL Sheet Metal Torx-T25 w/Pin SS	4	r	FAST-Z0027 Screw #10-24 x 2" Flat Machine Torx ZP	2	
	Part No.	Description	Qty.																																																								
	a	HDWT-S0149 Top Hinge Flat w/Bushing SS	1																																																								
	b	HDWT-T103 Pin, Top Hinge	1																																																								
	c	HDWT-S0150 Bottom Hinge Flat SS	1																																																								
	d	HDWT-T113 Pin, Bottom Hinge	1																																																								
	e	HDWT-T211 Cam, Bottom Hinge	1																																																								
	f	HDWT-T118 3/8"-16 Lock Nut, Bottom Hinge	1																																																								
	g	HDWT-T290 Hardware Kit, Concealed Latch	1																																																								
	h	HDWT-Z0022 Flat Strike/Keeper I/S & O/S	1																																																								
	i	HDWT-S275 Coat Hook Outswing Stainless Steel	1																																																								
	j	FAST-T381 Anchor - Plastic #10-12 x 1" Lg.	4																																																								
	k	HDW0-Z0167 Door Pull with Countersink	1																																																								
	l	FAST-Z0006 Screw #10 x 3/4" FL Sheet Metal Torx-T25 w/Pin ZP	2																																																								
	m	FAST-Z0019 Screw #10 x 5/8" Sheet Metal Torx-T27 w/Pin ZP	2																																																								
	n	FAST-Z0016 Screw #14 x 5/8" Sheet Metal Torx-T27 w/Pin ZP	2																																																								
o	HDWT-Z282 Door Pull ZP	1																																																									
p	HDWT-Z177 Wall Bumper	1																																																									
q	FAST-S0023 Screw #10 x 2" FL Sheet Metal Torx-T25 w/Pin SS	4																																																									
r	FAST-Z0027 Screw #10-24 x 2" Flat Machine Torx ZP	2																																																									
Also available in Stainless Steel - HDWT-SD2-FSH	\$ 204.00																																																										
NOTE: Torx bits are not included but can be ordered separately.																																																											

Prices subject to change without notice.
Items may be changed or discontinued
without notice and without incurring obligation.

Effective Date April 1, 2018

Outswing Door Kits

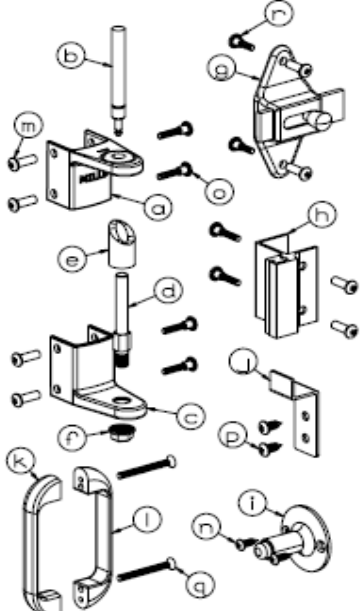
6 Outswing Door Kit with Surface Latch & W/A Strike/Keeper	HDWT-ZD2-SLWS	List Price																																																									
	Includes:	\$ 83.00																																																									
	<table border="1"> <thead> <tr> <th>Part No.</th> <th>Description</th> <th>Qty.</th> </tr> </thead> <tbody> <tr><td>a</td><td>HDWT-T101 Top Hinge w/Bushing</td><td>1</td></tr> <tr><td>b</td><td>HDWT-T103 Pin, Top Hinge</td><td>1</td></tr> <tr><td>c</td><td>HDWT-T112 Bottom Hinge</td><td>1</td></tr> <tr><td>d</td><td>HDWT-T113 Pin, Bottom Hinge</td><td>1</td></tr> <tr><td>e</td><td>HDWT-T211 Cam, Bottom Hinge</td><td>1</td></tr> <tr><td>f</td><td>HDWT-T118 3/8"-16 Lock Nut, Bottom Hinge</td><td>1</td></tr> <tr><td>g</td><td>HDWT-Z0124 Latch, Slide Surface Mount ZP</td><td>1</td></tr> <tr><td>h</td><td>HDWT-Z0126 Strike/Keeper Outswing ZP</td><td>1</td></tr> <tr><td>i</td><td>HDWT-Z177 Wall Bumper</td><td>1</td></tr> <tr><td>j</td><td>HDWT-S275 Coat Hook Outswing Stainless Steel</td><td>1</td></tr> <tr><td>k</td><td>HDWT-Z282 Door Pull ZP</td><td>1</td></tr> <tr><td>l</td><td>HDW0-Z0167 Door Pull with Countersink</td><td>1</td></tr> <tr><td>m</td><td>FAST-Z004A Screw #10-24 x 1" Step-Male Torx-T27 w/Pin ZP</td><td>6</td></tr> <tr><td>n</td><td>FAST-Z0019 Screw #10 x 5/8" Sheet Metal Torx-T27 w/Pin ZP</td><td>2</td></tr> <tr><td>o</td><td>FAST-Z003 Screw #10-24 x 3/4" Barrel-Female Torx-T27 w/Pin ZP</td><td>8</td></tr> <tr><td>p</td><td>FAST-Z0016 Screw #14 x 5/8" Sheet Metal Torx-T27 w/Pin ZP</td><td>2</td></tr> <tr><td>q</td><td>FAST-Z0027 Screw #10-24 x 2" Flat Machine Torx ZP</td><td>2</td></tr> <tr><td>r</td><td>FAST-Z004 Screw #10-24 x 3/4" Step-Male Torx-T27 ZP</td><td>2</td></tr> </tbody> </table>	Part No.	Description	Qty.	a	HDWT-T101 Top Hinge w/Bushing	1	b	HDWT-T103 Pin, Top Hinge	1	c	HDWT-T112 Bottom Hinge	1	d	HDWT-T113 Pin, Bottom Hinge	1	e	HDWT-T211 Cam, Bottom Hinge	1	f	HDWT-T118 3/8"-16 Lock Nut, Bottom Hinge	1	g	HDWT-Z0124 Latch, Slide Surface Mount ZP	1	h	HDWT-Z0126 Strike/Keeper Outswing ZP	1	i	HDWT-Z177 Wall Bumper	1	j	HDWT-S275 Coat Hook Outswing Stainless Steel	1	k	HDWT-Z282 Door Pull ZP	1	l	HDW0-Z0167 Door Pull with Countersink	1	m	FAST-Z004A Screw #10-24 x 1" Step-Male Torx-T27 w/Pin ZP	6	n	FAST-Z0019 Screw #10 x 5/8" Sheet Metal Torx-T27 w/Pin ZP	2	o	FAST-Z003 Screw #10-24 x 3/4" Barrel-Female Torx-T27 w/Pin ZP	8	p	FAST-Z0016 Screw #14 x 5/8" Sheet Metal Torx-T27 w/Pin ZP	2	q	FAST-Z0027 Screw #10-24 x 2" Flat Machine Torx ZP	2	r	FAST-Z004 Screw #10-24 x 3/4" Step-Male Torx-T27 ZP	2	
	Part No.	Description	Qty.																																																								
	a	HDWT-T101 Top Hinge w/Bushing	1																																																								
	b	HDWT-T103 Pin, Top Hinge	1																																																								
	c	HDWT-T112 Bottom Hinge	1																																																								
	d	HDWT-T113 Pin, Bottom Hinge	1																																																								
	e	HDWT-T211 Cam, Bottom Hinge	1																																																								
	f	HDWT-T118 3/8"-16 Lock Nut, Bottom Hinge	1																																																								
	g	HDWT-Z0124 Latch, Slide Surface Mount ZP	1																																																								
	h	HDWT-Z0126 Strike/Keeper Outswing ZP	1																																																								
	i	HDWT-Z177 Wall Bumper	1																																																								
	j	HDWT-S275 Coat Hook Outswing Stainless Steel	1																																																								
	k	HDWT-Z282 Door Pull ZP	1																																																								
	l	HDW0-Z0167 Door Pull with Countersink	1																																																								
	m	FAST-Z004A Screw #10-24 x 1" Step-Male Torx-T27 w/Pin ZP	6																																																								
	n	FAST-Z0019 Screw #10 x 5/8" Sheet Metal Torx-T27 w/Pin ZP	2																																																								
	o	FAST-Z003 Screw #10-24 x 3/4" Barrel-Female Torx-T27 w/Pin ZP	8																																																								
	p	FAST-Z0016 Screw #14 x 5/8" Sheet Metal Torx-T27 w/Pin ZP	2																																																								
	q	FAST-Z0027 Screw #10-24 x 2" Flat Machine Torx ZP	2																																																								
r	FAST-Z004 Screw #10-24 x 3/4" Step-Male Torx-T27 ZP	2																																																									
Also available in Stainless Steel - HDWT-SD2-SLWS	\$ 171.00																																																										
NOTE: Torx bits are not included but can be ordered separately.																																																											

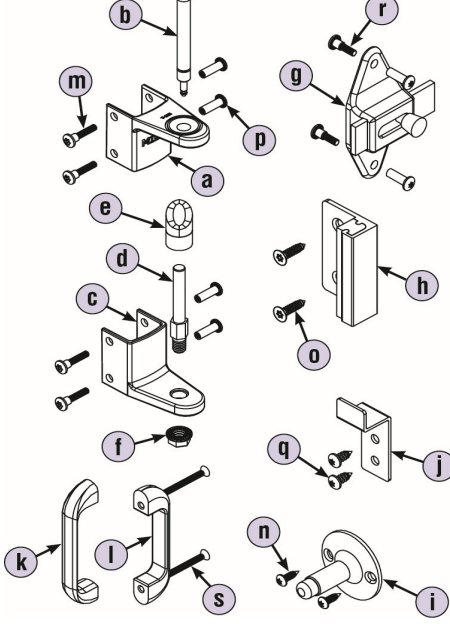
6 Outswing Door Kit with Surface Latch & Flat Strike/Keeper	HDWT-ZD2-SLFS	List Price																																																												
	Includes:	\$ 70.00																																																												
	<table border="1"> <thead> <tr> <th>Part No.</th> <th>Description</th> <th>Qty.</th> </tr> </thead> <tbody> <tr><td>a</td><td>HDWT-T101 Top Hinge w/Bushing</td><td>1</td></tr> <tr><td>b</td><td>HDWT-T103 Pin, Top Hinge</td><td>1</td></tr> <tr><td>c</td><td>HDWT-T112 Bottom Hinge</td><td>1</td></tr> <tr><td>d</td><td>HDWT-T113 Pin, Bottom Hinge</td><td>1</td></tr> <tr><td>e</td><td>HDWT-T211 Cam, Bottom Hinge</td><td>1</td></tr> <tr><td>f</td><td>HDWT-T118 3/8"-16 Lock Nut, Bottom Hinge</td><td>1</td></tr> <tr><td>g</td><td>HDWT-Z0124 Latch, Slide Surface Mount ZP</td><td>1</td></tr> <tr><td>h</td><td>HDWT-Z0128 Flat Strike/Keeper Outswing ZP</td><td>1</td></tr> <tr><td>i</td><td>HDWT-Z177 Wall Bumper</td><td>1</td></tr> <tr><td>j</td><td>HDWT-S275 Coat Hook Outswing Stainless Steel</td><td>1</td></tr> <tr><td>k</td><td>HDWT-Z282 Door Pull ZP</td><td>1</td></tr> <tr><td>l</td><td>HDW0-Z0167 Door Pull with Countersink</td><td>1</td></tr> <tr><td>m</td><td>FAST-Z004A Screw #10-24 x 1" Step-Male Torx-T27 w/Pin ZP</td><td>4</td></tr> <tr><td>n</td><td>FAST-Z0019 Screw #10 x 5/8" Sheet Metal Torx-T27 w/Pin ZP</td><td>2</td></tr> <tr><td>o</td><td>FAST-Z0006 Screw #10 x 3/4" FL Sheet Metal Torx-T25 w/Pin ZP</td><td>2</td></tr> <tr><td>p</td><td>FAST-Z003 Screw #10-24 x 3/4" Barrel-Female Torx-T27 w/Pin ZP</td><td>6</td></tr> <tr><td>q</td><td>FAST-Z0016 Screw #14 x 5/8" Sheet Metal Torx-T27 w/Pin ZP</td><td>2</td></tr> <tr><td>r</td><td>FAST-Z004 Screw #10-24 x 3/4" Step-Male Torx-T27 ZP</td><td>2</td></tr> <tr><td>s</td><td>FAST-Z0027 Screw #10-24 x 2" Flat Machine Torx ZP</td><td>2</td></tr> </tbody> </table>	Part No.	Description	Qty.	a	HDWT-T101 Top Hinge w/Bushing	1	b	HDWT-T103 Pin, Top Hinge	1	c	HDWT-T112 Bottom Hinge	1	d	HDWT-T113 Pin, Bottom Hinge	1	e	HDWT-T211 Cam, Bottom Hinge	1	f	HDWT-T118 3/8"-16 Lock Nut, Bottom Hinge	1	g	HDWT-Z0124 Latch, Slide Surface Mount ZP	1	h	HDWT-Z0128 Flat Strike/Keeper Outswing ZP	1	i	HDWT-Z177 Wall Bumper	1	j	HDWT-S275 Coat Hook Outswing Stainless Steel	1	k	HDWT-Z282 Door Pull ZP	1	l	HDW0-Z0167 Door Pull with Countersink	1	m	FAST-Z004A Screw #10-24 x 1" Step-Male Torx-T27 w/Pin ZP	4	n	FAST-Z0019 Screw #10 x 5/8" Sheet Metal Torx-T27 w/Pin ZP	2	o	FAST-Z0006 Screw #10 x 3/4" FL Sheet Metal Torx-T25 w/Pin ZP	2	p	FAST-Z003 Screw #10-24 x 3/4" Barrel-Female Torx-T27 w/Pin ZP	6	q	FAST-Z0016 Screw #14 x 5/8" Sheet Metal Torx-T27 w/Pin ZP	2	r	FAST-Z004 Screw #10-24 x 3/4" Step-Male Torx-T27 ZP	2	s	FAST-Z0027 Screw #10-24 x 2" Flat Machine Torx ZP	2	
	Part No.	Description	Qty.																																																											
	a	HDWT-T101 Top Hinge w/Bushing	1																																																											
	b	HDWT-T103 Pin, Top Hinge	1																																																											
	c	HDWT-T112 Bottom Hinge	1																																																											
	d	HDWT-T113 Pin, Bottom Hinge	1																																																											
	e	HDWT-T211 Cam, Bottom Hinge	1																																																											
	f	HDWT-T118 3/8"-16 Lock Nut, Bottom Hinge	1																																																											
	g	HDWT-Z0124 Latch, Slide Surface Mount ZP	1																																																											
	h	HDWT-Z0128 Flat Strike/Keeper Outswing ZP	1																																																											
	i	HDWT-Z177 Wall Bumper	1																																																											
	j	HDWT-S275 Coat Hook Outswing Stainless Steel	1																																																											
	k	HDWT-Z282 Door Pull ZP	1																																																											
	l	HDW0-Z0167 Door Pull with Countersink	1																																																											
	m	FAST-Z004A Screw #10-24 x 1" Step-Male Torx-T27 w/Pin ZP	4																																																											
	n	FAST-Z0019 Screw #10 x 5/8" Sheet Metal Torx-T27 w/Pin ZP	2																																																											
	o	FAST-Z0006 Screw #10 x 3/4" FL Sheet Metal Torx-T25 w/Pin ZP	2																																																											
	p	FAST-Z003 Screw #10-24 x 3/4" Barrel-Female Torx-T27 w/Pin ZP	6																																																											
	q	FAST-Z0016 Screw #14 x 5/8" Sheet Metal Torx-T27 w/Pin ZP	2																																																											
r	FAST-Z004 Screw #10-24 x 3/4" Step-Male Torx-T27 ZP	2																																																												
s	FAST-Z0027 Screw #10-24 x 2" Flat Machine Torx ZP	2																																																												
Also available in Stainless Steel - HDWT-SD2-SLFS	\$ 170.00																																																													
NOTE: Torx bits are not included but can be ordered separately.																																																														

Prices subject to change without notice.
Items may be changed or discontinued
without notice and without incurring obligation.

Effective Date April 1, 2018

Outswing Door Kits

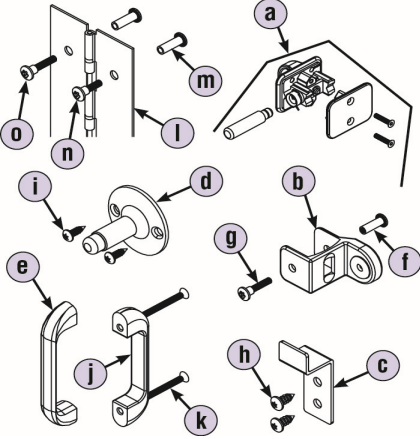
6 Outswing Door Kit with Piano Hinge (RHI/LHO)	HDWT-Z0235	List Price																																																
	Includes:	\$ 192.00																																																
	<table border="1"> <thead> <tr> <th>Part No.</th> <th>Description</th> <th>Qty.</th> </tr> </thead> <tbody> <tr> <td>a</td> <td>HDWT-T290 Hardware Kit, Concealed Latch</td> <td>1</td> </tr> <tr> <td>b</td> <td>HDWT-Z0119 Wrap Around Strike Keeper</td> <td>1</td> </tr> <tr> <td>c</td> <td>HDWT-S275 Coat Hook Outswing Stainless Steel</td> <td>1</td> </tr> <tr> <td>d</td> <td>HDWT-Z177 Wall Bumper</td> <td>1</td> </tr> <tr> <td>e</td> <td>HDWT-Z282 Door Pull</td> <td>1</td> </tr> <tr> <td>f</td> <td>FAST-Z003 Screw #10-24 x 3/4" Barrel-Female Torx-T27 w/Pin ZP</td> <td>1</td> </tr> <tr> <td>g</td> <td>FAST-Z004A Screw #10-24 x 1" Step-Male Torx-T27 w/Pin ZP</td> <td>1</td> </tr> <tr> <td>h</td> <td>FAST-Z0016 Screw #14 x 5/8" Sheet Metal Torx-T27 w/Pin ZP</td> <td>2</td> </tr> <tr> <td>i</td> <td>FAST-Z0019 Screw #10 x 5/8" Sheet Metal Torx-T27 w/Pin ZP</td> <td>2</td> </tr> <tr> <td>j</td> <td>HDW0-Z0167 Door Pull with Countersink</td> <td>1</td> </tr> <tr> <td>k</td> <td>FAST-Z0027 Screw #10-24 x 2" Flat Machine Torx ZP</td> <td>2</td> </tr> <tr> <td>l</td> <td>HDWT-S0208 Piano Hinge, Continuous Stainless Steel (RHI-LHO)</td> <td>1</td> </tr> <tr> <td>m</td> <td>FAST-P003 Screw #10-24 x 3/4" BTN Barrel-Female Torx-T27 w/Pin SS</td> <td>14</td> </tr> <tr> <td>n</td> <td>FAST-P004 Screw #10-24 x 3/4" BTN Step-Male Torx-T27 SS</td> <td>7</td> </tr> <tr> <td>o</td> <td>FAST-P004A Screw #10-24 x 1" Shoulder Torx-T27 SS</td> <td>7</td> </tr> </tbody> </table>	Part No.	Description	Qty.	a	HDWT-T290 Hardware Kit, Concealed Latch	1	b	HDWT-Z0119 Wrap Around Strike Keeper	1	c	HDWT-S275 Coat Hook Outswing Stainless Steel	1	d	HDWT-Z177 Wall Bumper	1	e	HDWT-Z282 Door Pull	1	f	FAST-Z003 Screw #10-24 x 3/4" Barrel-Female Torx-T27 w/Pin ZP	1	g	FAST-Z004A Screw #10-24 x 1" Step-Male Torx-T27 w/Pin ZP	1	h	FAST-Z0016 Screw #14 x 5/8" Sheet Metal Torx-T27 w/Pin ZP	2	i	FAST-Z0019 Screw #10 x 5/8" Sheet Metal Torx-T27 w/Pin ZP	2	j	HDW0-Z0167 Door Pull with Countersink	1	k	FAST-Z0027 Screw #10-24 x 2" Flat Machine Torx ZP	2	l	HDWT-S0208 Piano Hinge, Continuous Stainless Steel (RHI-LHO)	1	m	FAST-P003 Screw #10-24 x 3/4" BTN Barrel-Female Torx-T27 w/Pin SS	14	n	FAST-P004 Screw #10-24 x 3/4" BTN Step-Male Torx-T27 SS	7	o	FAST-P004A Screw #10-24 x 1" Shoulder Torx-T27 SS	7	
	Part No.	Description	Qty.																																															
	a	HDWT-T290 Hardware Kit, Concealed Latch	1																																															
	b	HDWT-Z0119 Wrap Around Strike Keeper	1																																															
	c	HDWT-S275 Coat Hook Outswing Stainless Steel	1																																															
	d	HDWT-Z177 Wall Bumper	1																																															
	e	HDWT-Z282 Door Pull	1																																															
	f	FAST-Z003 Screw #10-24 x 3/4" Barrel-Female Torx-T27 w/Pin ZP	1																																															
	g	FAST-Z004A Screw #10-24 x 1" Step-Male Torx-T27 w/Pin ZP	1																																															
	h	FAST-Z0016 Screw #14 x 5/8" Sheet Metal Torx-T27 w/Pin ZP	2																																															
	i	FAST-Z0019 Screw #10 x 5/8" Sheet Metal Torx-T27 w/Pin ZP	2																																															
	j	HDW0-Z0167 Door Pull with Countersink	1																																															
	k	FAST-Z0027 Screw #10-24 x 2" Flat Machine Torx ZP	2																																															
	l	HDWT-S0208 Piano Hinge, Continuous Stainless Steel (RHI-LHO)	1																																															
m	FAST-P003 Screw #10-24 x 3/4" BTN Barrel-Female Torx-T27 w/Pin SS	14																																																
n	FAST-P004 Screw #10-24 x 3/4" BTN Step-Male Torx-T27 SS	7																																																
o	FAST-P004A Screw #10-24 x 1" Shoulder Torx-T27 SS	7																																																
Also available in Stainless Steel - HDWT-S0235	\$ 237.00																																																	

NOTE: Torx bits are not included but can be ordered separately.

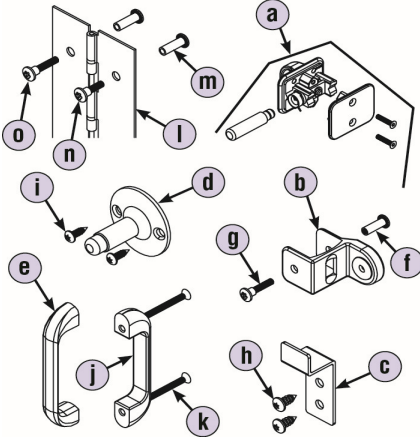
6 Outswing Door Kit with Piano Hinge (LHI/RHO)	HDWT-Z0237	List Price																																																
	Includes:	\$ 192.00																																																
	<table border="1"> <thead> <tr> <th>Part No.</th> <th>Description</th> <th>Qty.</th> </tr> </thead> <tbody> <tr> <td>a</td> <td>HDWT-T290 Hardware Kit, Concealed Latch</td> <td>1</td> </tr> <tr> <td>b</td> <td>HDWT-Z0119 Wrap Around Strike Keeper</td> <td>1</td> </tr> <tr> <td>c</td> <td>HDWT-S275 Coat Hook Outswing Stainless Steel</td> <td>1</td> </tr> <tr> <td>d</td> <td>HDWT-Z177 Wall Bumper</td> <td>1</td> </tr> <tr> <td>e</td> <td>HDWT-Z282 Door Pull</td> <td>1</td> </tr> <tr> <td>f</td> <td>FAST-Z003 Screw #10-24 x 3/4" Barrel-Female Torx-T27 w/Pin ZP</td> <td>1</td> </tr> <tr> <td>g</td> <td>FAST-Z004A Screw #10-24 x 1" Step-Male Torx-T27 w/Pin ZP</td> <td>1</td> </tr> <tr> <td>h</td> <td>FAST-Z0016 Screw #14 x 5/8" Sheet Metal Torx-T27 w/Pin ZP</td> <td>2</td> </tr> <tr> <td>i</td> <td>FAST-Z0019 Screw #10 x 5/8" Sheet Metal Torx-T27 w/Pin ZP</td> <td>2</td> </tr> <tr> <td>j</td> <td>HDW0-Z0167 Door Pull with Countersink</td> <td>1</td> </tr> <tr> <td>k</td> <td>FAST-Z0027 Screw #10-24 x 2" Flat Machine Torx ZP</td> <td>2</td> </tr> <tr> <td>l</td> <td>HDWT-S0209 Piano Hinge, Continuous Stainless Steel (LHI-RHO)</td> <td>1</td> </tr> <tr> <td>m</td> <td>FAST-P003 Screw #10-24 x 3/4" BTN Barrel-Female Torx-T27 w/Pin SS</td> <td>14</td> </tr> <tr> <td>n</td> <td>FAST-P004 Screw #10-24 x 3/4" BTN Step-Male Torx-T27 SS</td> <td>7</td> </tr> <tr> <td>o</td> <td>FAST-P004A Screw #10-24 x 1" Shoulder Torx-T27 SS</td> <td>7</td> </tr> </tbody> </table>	Part No.	Description	Qty.	a	HDWT-T290 Hardware Kit, Concealed Latch	1	b	HDWT-Z0119 Wrap Around Strike Keeper	1	c	HDWT-S275 Coat Hook Outswing Stainless Steel	1	d	HDWT-Z177 Wall Bumper	1	e	HDWT-Z282 Door Pull	1	f	FAST-Z003 Screw #10-24 x 3/4" Barrel-Female Torx-T27 w/Pin ZP	1	g	FAST-Z004A Screw #10-24 x 1" Step-Male Torx-T27 w/Pin ZP	1	h	FAST-Z0016 Screw #14 x 5/8" Sheet Metal Torx-T27 w/Pin ZP	2	i	FAST-Z0019 Screw #10 x 5/8" Sheet Metal Torx-T27 w/Pin ZP	2	j	HDW0-Z0167 Door Pull with Countersink	1	k	FAST-Z0027 Screw #10-24 x 2" Flat Machine Torx ZP	2	l	HDWT-S0209 Piano Hinge, Continuous Stainless Steel (LHI-RHO)	1	m	FAST-P003 Screw #10-24 x 3/4" BTN Barrel-Female Torx-T27 w/Pin SS	14	n	FAST-P004 Screw #10-24 x 3/4" BTN Step-Male Torx-T27 SS	7	o	FAST-P004A Screw #10-24 x 1" Shoulder Torx-T27 SS	7	
	Part No.	Description	Qty.																																															
	a	HDWT-T290 Hardware Kit, Concealed Latch	1																																															
	b	HDWT-Z0119 Wrap Around Strike Keeper	1																																															
	c	HDWT-S275 Coat Hook Outswing Stainless Steel	1																																															
	d	HDWT-Z177 Wall Bumper	1																																															
	e	HDWT-Z282 Door Pull	1																																															
	f	FAST-Z003 Screw #10-24 x 3/4" Barrel-Female Torx-T27 w/Pin ZP	1																																															
	g	FAST-Z004A Screw #10-24 x 1" Step-Male Torx-T27 w/Pin ZP	1																																															
	h	FAST-Z0016 Screw #14 x 5/8" Sheet Metal Torx-T27 w/Pin ZP	2																																															
	i	FAST-Z0019 Screw #10 x 5/8" Sheet Metal Torx-T27 w/Pin ZP	2																																															
	j	HDW0-Z0167 Door Pull with Countersink	1																																															
	k	FAST-Z0027 Screw #10-24 x 2" Flat Machine Torx ZP	2																																															
	l	HDWT-S0209 Piano Hinge, Continuous Stainless Steel (LHI-RHO)	1																																															
m	FAST-P003 Screw #10-24 x 3/4" BTN Barrel-Female Torx-T27 w/Pin SS	14																																																
n	FAST-P004 Screw #10-24 x 3/4" BTN Step-Male Torx-T27 SS	7																																																
o	FAST-P004A Screw #10-24 x 1" Shoulder Torx-T27 SS	7																																																
Also available in Stainless Steel - HDWT-S0237	\$ 237.00																																																	

NOTE: Torx bits are not included but can be ordered separately.

Effective Date April 1, 2018

Outswing Door Kits

6 Outswing Flat Strike Door Kit with Piano Hinge (RHI/LHO)	HDWT-Z0239	List Price																																													
	Includes:	\$ 192.00																																													
	<table border="1"> <thead> <tr> <th>Part No.</th> <th>Description</th> <th>Qty.</th> </tr> </thead> <tbody> <tr> <td>a</td> <td>HDWT-T290 Hardware Kit, Concealed Latch</td> <td>1</td> </tr> <tr> <td>b</td> <td>HDWT-Z0022 Flat Strike Keeper</td> <td>1</td> </tr> <tr> <td>c</td> <td>HDWT-S275 Coat Hook Outswing Stainless Steel</td> <td>1</td> </tr> <tr> <td>d</td> <td>HDWT-Z177 Wall Bumper</td> <td>1</td> </tr> <tr> <td>e</td> <td>HDWT-Z282 Door Pull</td> <td>1</td> </tr> <tr> <td>f</td> <td>FAST-Z0006 Screw #10 x 3/4" FL Sheet Metal Torx-T25 w/Pin ZP</td> <td>2</td> </tr> <tr> <td>g</td> <td>FAST-Z0019 Screw #10 x 5/8" Sheet Metal Torx-T27 w/Pin ZP</td> <td>2</td> </tr> <tr> <td>h</td> <td>FAST-Z0016 Screw #14 x 5/8" Sheet Metal Torx-T27 w/Pin ZP</td> <td>2</td> </tr> <tr> <td>i</td> <td>HDW0-Z0167 Door Pull with Countersink</td> <td>1</td> </tr> <tr> <td>j</td> <td>FAST-Z0027 Screw #10-24 x 2" Flat Machine Torx ZP</td> <td>2</td> </tr> <tr> <td>k</td> <td>HDWT-S0208 Piano Hinge, Continuous Stainless Steel (RHI-LHO)</td> <td>1</td> </tr> <tr> <td>l</td> <td>FAST-P003 Screw #10-24 x 3/4" BTN Barrel-Female Torx-T27 w/Pin SS</td> <td>14</td> </tr> <tr> <td>m</td> <td>FAST-P004 Screw #10-24 x 3/4" BTN Step-Male Torx-T27 SS</td> <td>7</td> </tr> <tr> <td>n</td> <td>FAST-P004A Screw #10-24 x 1" Shoulder Torx-T27 SS</td> <td>7</td> </tr> </tbody> </table>	Part No.	Description	Qty.	a	HDWT-T290 Hardware Kit, Concealed Latch	1	b	HDWT-Z0022 Flat Strike Keeper	1	c	HDWT-S275 Coat Hook Outswing Stainless Steel	1	d	HDWT-Z177 Wall Bumper	1	e	HDWT-Z282 Door Pull	1	f	FAST-Z0006 Screw #10 x 3/4" FL Sheet Metal Torx-T25 w/Pin ZP	2	g	FAST-Z0019 Screw #10 x 5/8" Sheet Metal Torx-T27 w/Pin ZP	2	h	FAST-Z0016 Screw #14 x 5/8" Sheet Metal Torx-T27 w/Pin ZP	2	i	HDW0-Z0167 Door Pull with Countersink	1	j	FAST-Z0027 Screw #10-24 x 2" Flat Machine Torx ZP	2	k	HDWT-S0208 Piano Hinge, Continuous Stainless Steel (RHI-LHO)	1	l	FAST-P003 Screw #10-24 x 3/4" BTN Barrel-Female Torx-T27 w/Pin SS	14	m	FAST-P004 Screw #10-24 x 3/4" BTN Step-Male Torx-T27 SS	7	n	FAST-P004A Screw #10-24 x 1" Shoulder Torx-T27 SS	7	
	Part No.	Description	Qty.																																												
	a	HDWT-T290 Hardware Kit, Concealed Latch	1																																												
	b	HDWT-Z0022 Flat Strike Keeper	1																																												
	c	HDWT-S275 Coat Hook Outswing Stainless Steel	1																																												
	d	HDWT-Z177 Wall Bumper	1																																												
	e	HDWT-Z282 Door Pull	1																																												
	f	FAST-Z0006 Screw #10 x 3/4" FL Sheet Metal Torx-T25 w/Pin ZP	2																																												
	g	FAST-Z0019 Screw #10 x 5/8" Sheet Metal Torx-T27 w/Pin ZP	2																																												
	h	FAST-Z0016 Screw #14 x 5/8" Sheet Metal Torx-T27 w/Pin ZP	2																																												
	i	HDW0-Z0167 Door Pull with Countersink	1																																												
	j	FAST-Z0027 Screw #10-24 x 2" Flat Machine Torx ZP	2																																												
	k	HDWT-S0208 Piano Hinge, Continuous Stainless Steel (RHI-LHO)	1																																												
	l	FAST-P003 Screw #10-24 x 3/4" BTN Barrel-Female Torx-T27 w/Pin SS	14																																												
m	FAST-P004 Screw #10-24 x 3/4" BTN Step-Male Torx-T27 SS	7																																													
n	FAST-P004A Screw #10-24 x 1" Shoulder Torx-T27 SS	7																																													
Also available in Stainless Steel - HDWT-S0239	\$ 237.00																																														

NOTE: Torx bits are not included but can be ordered separately.

6 Outswing Flat Strike Door Kit with Piano Hinge (LHI/RHO)	HDWT-Z0241	List Price																																													
	Includes:	\$ 192.00																																													
	<table border="1"> <thead> <tr> <th>Part No.</th> <th>Description</th> <th>Qty.</th> </tr> </thead> <tbody> <tr> <td>a</td> <td>HDWT-T290 Hardware Kit, Concealed Latch</td> <td>1</td> </tr> <tr> <td>b</td> <td>HDWT-Z0022 Flat Strike Keeper</td> <td>1</td> </tr> <tr> <td>c</td> <td>HDWT-S275 Coat Hook Outswing Stainless Steel</td> <td>1</td> </tr> <tr> <td>d</td> <td>HDWT-Z177 Wall Bumper</td> <td>1</td> </tr> <tr> <td>e</td> <td>HDWT-Z282 Door Pull</td> <td>1</td> </tr> <tr> <td>f</td> <td>FAST-Z0006 Screw #10 x 3/4" FL Sheet Metal Torx-T25 w/Pin ZP</td> <td>2</td> </tr> <tr> <td>g</td> <td>FAST-Z0019 Screw #10 x 5/8" Sheet Metal Torx-T27 w/Pin ZP</td> <td>2</td> </tr> <tr> <td>h</td> <td>FAST-Z0016 Screw #14 x 5/8" Sheet Metal Torx-T27 w/Pin ZP</td> <td>2</td> </tr> <tr> <td>i</td> <td>HDW0-Z0167 Door Pull with Countersink</td> <td>1</td> </tr> <tr> <td>j</td> <td>FAST-Z0027 Screw #10-24 x 2" Flat Machine Torx ZP</td> <td>2</td> </tr> <tr> <td>k</td> <td>HDWT-S0209 Piano Hinge, Continuous Stainless Steel (LHI-RHO)</td> <td>1</td> </tr> <tr> <td>l</td> <td>FAST-P003 Screw #10-24 x 3/4" BTN Barrel-Female Torx-T27 w/Pin SS</td> <td>14</td> </tr> <tr> <td>m</td> <td>FAST-P004 Screw #10-24 x 3/4" BTN Step-Male Torx-T27 SS</td> <td>7</td> </tr> <tr> <td>n</td> <td>FAST-P004A Screw #10-24 x 1" Shoulder Torx-T27 SS</td> <td>7</td> </tr> </tbody> </table>	Part No.	Description	Qty.	a	HDWT-T290 Hardware Kit, Concealed Latch	1	b	HDWT-Z0022 Flat Strike Keeper	1	c	HDWT-S275 Coat Hook Outswing Stainless Steel	1	d	HDWT-Z177 Wall Bumper	1	e	HDWT-Z282 Door Pull	1	f	FAST-Z0006 Screw #10 x 3/4" FL Sheet Metal Torx-T25 w/Pin ZP	2	g	FAST-Z0019 Screw #10 x 5/8" Sheet Metal Torx-T27 w/Pin ZP	2	h	FAST-Z0016 Screw #14 x 5/8" Sheet Metal Torx-T27 w/Pin ZP	2	i	HDW0-Z0167 Door Pull with Countersink	1	j	FAST-Z0027 Screw #10-24 x 2" Flat Machine Torx ZP	2	k	HDWT-S0209 Piano Hinge, Continuous Stainless Steel (LHI-RHO)	1	l	FAST-P003 Screw #10-24 x 3/4" BTN Barrel-Female Torx-T27 w/Pin SS	14	m	FAST-P004 Screw #10-24 x 3/4" BTN Step-Male Torx-T27 SS	7	n	FAST-P004A Screw #10-24 x 1" Shoulder Torx-T27 SS	7	
	Part No.	Description	Qty.																																												
	a	HDWT-T290 Hardware Kit, Concealed Latch	1																																												
	b	HDWT-Z0022 Flat Strike Keeper	1																																												
	c	HDWT-S275 Coat Hook Outswing Stainless Steel	1																																												
	d	HDWT-Z177 Wall Bumper	1																																												
	e	HDWT-Z282 Door Pull	1																																												
	f	FAST-Z0006 Screw #10 x 3/4" FL Sheet Metal Torx-T25 w/Pin ZP	2																																												
	g	FAST-Z0019 Screw #10 x 5/8" Sheet Metal Torx-T27 w/Pin ZP	2																																												
	h	FAST-Z0016 Screw #14 x 5/8" Sheet Metal Torx-T27 w/Pin ZP	2																																												
	i	HDW0-Z0167 Door Pull with Countersink	1																																												
	j	FAST-Z0027 Screw #10-24 x 2" Flat Machine Torx ZP	2																																												
	k	HDWT-S0209 Piano Hinge, Continuous Stainless Steel (LHI-RHO)	1																																												
	l	FAST-P003 Screw #10-24 x 3/4" BTN Barrel-Female Torx-T27 w/Pin SS	14																																												
m	FAST-P004 Screw #10-24 x 3/4" BTN Step-Male Torx-T27 SS	7																																													
n	FAST-P004A Screw #10-24 x 1" Shoulder Torx-T27 SS	7																																													
Also available in Stainless Steel - HDWT-S0241	\$ 237.00																																														

NOTE: Torx bits are not included but can be ordered separately.

Effective Date April 1, 2018

Pilaster-Panel Kits

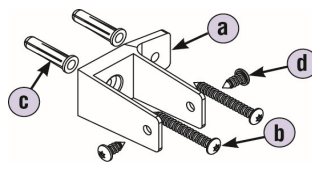
7 Pilaster at Wall "F" Bracket 	HDWT-Z3FF		List Price
	Includes:		\$ 32.00
	Part No.	Description	Qty.
a	HDWT-T337	Bracket, Single-Ear 1 1/4" x 2 1/2"	2
b	FAST-Z002	Screw #14 x 2" Sheet Metal Torx-T27 w/Pin ZP	4
c	FAST-T373	Anchor - Plastic #14-16 x 1 3/8" Lg.	4
d	FAST-Z0016	Screw #14 x 5/8" Sheet Metal Torx-T27 w/Pin ZP	4
Also available in Stainless Steel - HDWT-S3FF			\$ 57.00

NOTE: Torx bits are not included but can be ordered separately.

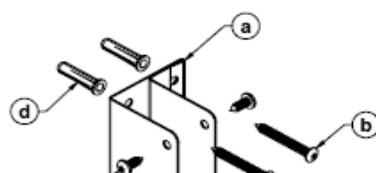
7 Pilaster at Wall "F" Bracket (Stainless Continuous) 	HDWT-S0480-57		List Price
	Includes:		\$ 79.00
	Part No.	DESCRIPTION	Qty.
a	HDWT-S184-57	Bracket "1-Ear" Continuous 1-1/4" X 57" Stainless	1
b	FAST-P002	Screw #14 X 2" BTN Sheet Metal Torx-T27 w/Pin SS	10
c	FAST-S355A	Screw 1/4-14 X 5/8" Sheet Metal Torx-T27 w/Pin SS	10
d	FAST-T373	Anchor - Plastic #14-16 X 1-3/8" Lg.	10

NOTE: Torx bits are not included but can be ordered separately.

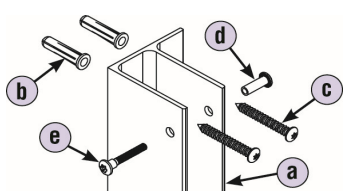
7 Pilaster at Wall "F" Bracket (Aluminum Continuous) 	HDWT-A0040		List Price
	Includes:		\$ 74.00
	Part No.	Description	Qty.
a	HDWT-A184	Bracket, Continuous, 1 1/4" Single-Ear Aluminum	1
b	FAST-T373	Anchor - Plastic #14-16 x 1 3/8" Lg.	10
c	FAST-P002	Screw #14 x 2" BTN Sheet Metal Torx-T27 w/Pin SS	10
d	FAST-P003	Screw #10-24 x 3/4" BTN Barrel-Female Torx-T27 w/Pin SS	5
e	FAST-P004A	Screw #10-24 x 1" Shoulder Torx-T27 SS	5

NOTE: Torx bits are not included but can be ordered separately.

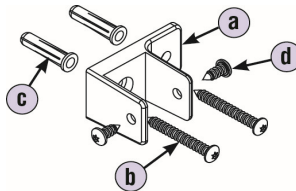
7 Pilaster at Wall Mini "F" Bracket 	HDWT-Z0068		List Price
	Includes:		\$ 21.00
	Part No.	Description	Qty.
a	HDWT-Z0037	Bracket, Mini "F" Single-Ear 1 1/4" x 1 3/4"	2
b	FAST-Z002	Screw #14 x 2" Sheet Metal Torx-T27 w/Pin ZP	4
c	FAST-T373	Anchor - Plastic #14-16 x 1 3/8" Lg.	4
d	FAST-Z0016	Screw #14 x 5/8" Sheet Metal Torx-T27 w/Pin ZP	4
Also available in Stainless Steel - HDWT-S0068			\$ 74.00

NOTE: Torx bits are not included but can be ordered separately.

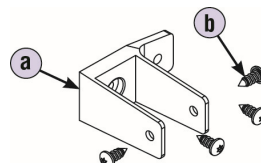
7 Pilaster at Pilaster/Panel "F" Bracket 	HDWT-Z0016		List Price
	Includes:		\$ 30.00
	Part No.	Description	Qty.
a	HDWT-T337	Bracket, Single-Ear 1 1/4" x 2 1/2"	2
b	FAST-Z0016	Screw #14 x 5/8" Sheet Metal Torx-T27 w/Pin ZP	8
Also available in Stainless Steel - HDWT-S0016			\$ 53.00

NOTE: Torx bits are not included but can be ordered separately.

Effective Date April 1, 2018

Pilaster-Panel Kits

7 Pilaster at Pilaster/Panel "F" Bracket (Stainless Continuous)	HDWT-S0481-57	List Price
--	----------------------	-------------------

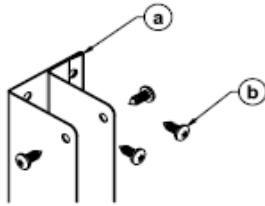

Includes:			\$ 75.00	
	Part No.	Description		Qty.
a	HDWT-S184-57	Bracket "1-ear" Continuous 1-1/4" X 57" Stainless		1
b	FAST-S355A	Screw 1/4-14 X 5/8" Sheet Metal Torx-T27 w/Pin SS	20	

NOTE: Torx bits are not included but can be ordered separately.

7 Pilaster at Pilaster/Panel "F" Bracket (Aluminum Continuous)	HDWT-A0041	List Price
---	-------------------	-------------------

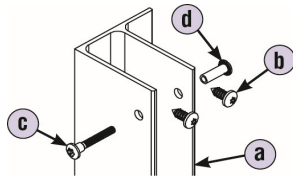

Includes:			\$ 71.00	
	Part No.	Description		Qty.
a	HDWT-A184	Bracket, Continuous, 1 1/4" Single-Ear Aluminum		1
b	FAST-S355A	Screw 1/4-14 x 5/8" Sheet Metal Torx-T27 w/Pin SS		10
c	FAST-P004A	Screw #10-24 x 1" Shoulder Torx-T27 SS		5
d	FAST-P003	Screw #10-24 x 3/4" BTN Barrel-Female Torx-T27 w/Pin SS	5	

NOTE: Torx bits are not included but can be ordered separately.

Effective Date April 1, 2018

Dividing Panel and Ending Panel Kits

8 Dividing Panel Kit 	HDWT-Z1PD		List Price
	Includes:		\$ 20.00
	Part No.	Description	Qty.
a	HDWT-T334	Bracket, Double-Ear 1" x 2½"	2
b	HDWT-T336	Bracket, No-Ear 1" x 1½"	2
c	FAST-Z002	Screw #14 x 2" Sheet Metal Torx-T27 w/Pin ZP	4
d	FAST-T373	Anchor - Plastic #14-16 x 1½" Lg.	4
e	FAST-Z0016	Screw #14 x ¾" Sheet Metal Torx-T27 w/Pin ZP	12
Also available in Stainless Steel - HDWT-S1PD			\$ 63.00

NOTE: Torx bits are not included but can be ordered separately.

8 Dividing Panel Kit (Aluminum Continuous) 	HDWT-A0055		List Price
	Includes:		\$ 108.00
	Part No.	Description	Qty.
a	HDWT-A186	Bracket, Continuous, Double-Ear Aluminum	1
b	HDWT-A185	Bracket, Continuous, "U"	1
c	FAST-T373	Anchor - Plastic #14-16 x 1½" Lg.	10
d	FAST-P002	Screw #14 x 2" BTN Sheet Metal Torx-T27 w/Pin SS	10
e	FAST-P003	Screw #10-24 x ¾" BTN Barrel-Female Torx-T27 w/Pin SS	10
f	FAST-P004	Screw #10-24 x ¾" BTN Step-Male Torx-T27 SS	10
g	FAST-S355A	Screw ¼-14 x ¾" Sheet Metal Torx-T27 w/Pin SS	5

NOTE: Torx bits are not included but can be ordered separately.

9 Ending Panel Kit 	HDWT-Z2PE		List Price
	Includes:		\$ 20.00
	Part No.	Description	Qty.
a	HDWT-T332	Bracket, Single-Ear 1" x 2½"	2
b	HDWT-T336	Bracket, No-Ear 1" x 1½"	2
c	FAST-Z002	Screw #14 x 2" Sheet Metal Torx-T27 w/Pin ZP	4
d	FAST-T373	Anchor - Plastic #14-16 x 1½" Lg.	4
e	FAST-Z0016	Screw #14 x ¾" Sheet Metal Torx-T27 w/Pin ZP	12
Also available in Stainless Steel - HDWT-S2PE			\$ 59.00

NOTE: Torx bits are not included but can be ordered separately.

9 Ending Panel Kit (Aluminum Continuous) 	HDWT-A0056		List Price
	Includes:		\$ 102.00
	Part No.	Description	Qty.
a	HDWT-A183	Bracket, Continuous, 1" Single-Ear Aluminum	1
b	HDWT-A185	Bracket, Continuous, "U"	1
c	FAST-T373	Anchor - Plastic #14-16 x 1½" Lg.	10
d	FAST-P002	Screw #14 x 2" BTN Sheet Metal Torx-T27 w/Pin SS	10
e	FAST-P003	Screw #10-24 x ¾" BTN Barrel-Female Torx-T27 w/Pin SS	10
f	FAST-P004	Screw #10-24 x ¾" BTN Step-Male Torx-T27 SS	10
g	FAST-S355A	Screw ¼-14 x ¾" Sheet Metal Torx-T27 w/Pin SS	5

NOTE: Torx bits are not included but can be ordered separately.

Effective Date April 1, 2018

Dividing Panel and Ending Panel Kits

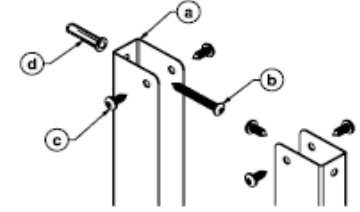
⑧	Dividing/Ending Panel @Wall Kit (Stainless Continuous)	HDWT-S0475-57	List Price															
⑨		Includes: <table border="1"> <thead> <tr> <th>Part No.</th> <th>Description</th> <th>Qty.</th> </tr> </thead> <tbody> <tr> <td>a</td> <td>S190-02-57 Bracket "U" Continuous 2" X 57"</td> <td>2</td> </tr> <tr> <td>b</td> <td>FAST-P002 Screw #14 X 2" BTN Sheet Metal Torx-T27 w/Pin SS</td> <td>5</td> </tr> <tr> <td>c</td> <td>FAST-S355A Screw 1/4-14 X 5/8" Sheet Metal Torx-T27 w/Pin SS</td> <td>25</td> </tr> <tr> <td>d</td> <td>FAST-T373 Anchor - Plastic #14-16 X 1-3/8" Lg.</td> <td>5</td> </tr> </tbody> </table>	Part No.	Description	Qty.	a	S190-02-57 Bracket "U" Continuous 2" X 57"	2	b	FAST-P002 Screw #14 X 2" BTN Sheet Metal Torx-T27 w/Pin SS	5	c	FAST-S355A Screw 1/4-14 X 5/8" Sheet Metal Torx-T27 w/Pin SS	25	d	FAST-T373 Anchor - Plastic #14-16 X 1-3/8" Lg.	5	\$ 135.00
Part No.	Description	Qty.																
a	S190-02-57 Bracket "U" Continuous 2" X 57"	2																
b	FAST-P002 Screw #14 X 2" BTN Sheet Metal Torx-T27 w/Pin SS	5																
c	FAST-S355A Screw 1/4-14 X 5/8" Sheet Metal Torx-T27 w/Pin SS	25																
d	FAST-T373 Anchor - Plastic #14-16 X 1-3/8" Lg.	5																

NOTE: Torx bits are not included but can be ordered separately.

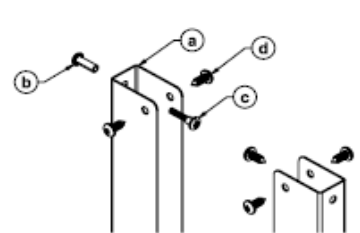
⑧	Dividing/Ending Panel @Pilaster Kit (Stainless Continuous)	HDWT-S0476-57	List Price															
⑨		Includes: <table border="1"> <thead> <tr> <th>Part No.</th> <th>Description</th> <th>Qty.</th> </tr> </thead> <tbody> <tr> <td>a</td> <td>S190-02-57 Bracket "U" Continuous 2" X 57"</td> <td>2</td> </tr> <tr> <td>b</td> <td>FAST-P003 Screw #10-24 X 3/4" BTN Barrel-Female Torx-T27 w/Pin SS</td> <td>5</td> </tr> <tr> <td>c</td> <td>FAST-P004A Screw #10-24 X 1" BTN Step-Male Torx-T27 w/Pin SS</td> <td>5</td> </tr> <tr> <td>d</td> <td>FAST-S355A Screw 1/4-14 X 5/8" Sheet Metal Torx-T27 w/Pin SS</td> <td>25</td> </tr> </tbody> </table>	Part No.	Description	Qty.	a	S190-02-57 Bracket "U" Continuous 2" X 57"	2	b	FAST-P003 Screw #10-24 X 3/4" BTN Barrel-Female Torx-T27 w/Pin SS	5	c	FAST-P004A Screw #10-24 X 1" BTN Step-Male Torx-T27 w/Pin SS	5	d	FAST-S355A Screw 1/4-14 X 5/8" Sheet Metal Torx-T27 w/Pin SS	25	\$ 135.00
Part No.	Description	Qty.																
a	S190-02-57 Bracket "U" Continuous 2" X 57"	2																
b	FAST-P003 Screw #10-24 X 3/4" BTN Barrel-Female Torx-T27 w/Pin SS	5																
c	FAST-P004A Screw #10-24 X 1" BTN Step-Male Torx-T27 w/Pin SS	5																
d	FAST-S355A Screw 1/4-14 X 5/8" Sheet Metal Torx-T27 w/Pin SS	25																

NOTE: Torx bits are not included but can be ordered separately.

Effective Date April 1, 2018

Additional Kits

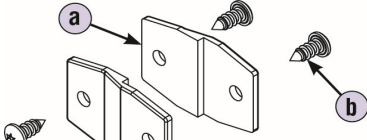
	HDWT-Z4AL			List Price
	Includes:			\$ 23.00
		Part No.	Description	Qty.
a	HDWT-T341	Bracket, Alcove Offset	4	
b	FAST-Z0016	Screw #14 x 3/8" Sheet Metal Torx-T27 w/Pin ZP	8	
Also available in Stainless Steel - HDWT-S4AL				\$ 55.00

NOTE: Torx bits are not included but can be ordered separately.

	HDWT-S0479-57			List Price
	Includes:			\$ 127.00
		PART NO.	DESCRIPTION	Qty.
a	HDWT-S0290-57	Bracket Continuous Alcove Offset	4	
b	FAST-S355A	Screw 1/4-14 X 5/8" Sheet Metal Torx-T27 w/Pin SS	40	

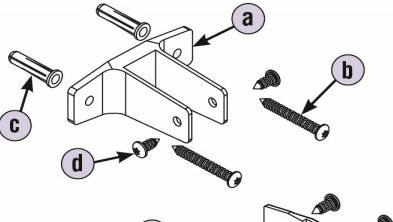
	HDWT-Z0286			List Price	
	Includes:			\$ 27.00	
		Part No.	Description	Qty.	
	a	HDWT-T334	Bracket, Double-Ear 1" x 2 1/2"	2	
	b	FAST-Z002	Screw #14 x 2" Sheet Metal Torx-T27 w/Pin ZP	4	
	c	FAST-T373	Anchor - Plastic #14-16 x 1 3/8" Lg.	4	
d	FAST-Z0016	Screw #14 x 3/8" Sheet Metal Torx-T27 w/Pin ZP	12		
e	HDWT-T341	Bracket, Alcove Offset	4		
Also available in Stainless Steel - HDWT-S0286				\$ 72.00	

NOTE: Torx bits are not included but can be ordered separately.

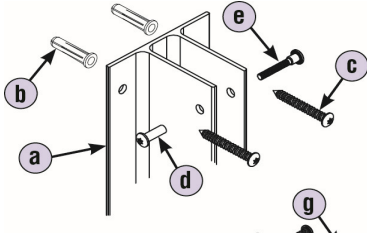
	HDWT-A0288			List Price	
	Includes:			\$ 88.00	
		Part No.	Description	Qty.	
	a	HDWT-A186	Bracket, Continuous 1" Double-Ear	1	
	b	FAST-T373	Anchor - Plastic #14-16 x 1 3/8" Lg.	10	
	c	FAST-P002	Screw #14 x 2" BTN Sheet Metal Torx-T27 w/Pin SS	10	
	d	FAST-P003	Screw #10-24 x 3/4" BTN Barrel-Female Torx-T27 w/Pin SS	5	
	e	FAST-P004	Screw #10-24 x 3/4" BTN Step-Male Torx-T27 SS	5	
f	HDWT-T341	Bracket, Alcove Offset	4		
g	FAST-Z0016	Screw #14 x 3/8" Sheet Metal Torx-T27 w/Pin ZP	8		

NOTE: Torx bits are not included but can be ordered separately.

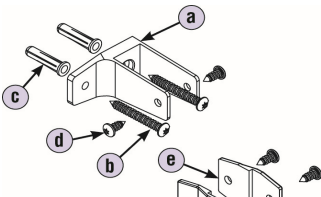
	HDWT-Z0287			List Price	
	Includes:			\$ 27.00	
		Part No.	Description	Qty.	
	a	HDWT-T332	Bracket, Single-Ear 1" x 2 1/2"	2	
	b	FAST-Z002	Screw #14 x 2" Sheet Metal Torx-T27 w/Pin ZP	4	
	c	FAST-T373	Anchor - Plastic #14-16 x 1 3/8" Lg.	4	
d	FAST-Z0016	Screw #14 x 3/8" Sheet Metal Torx-T27 w/Pin ZP	12		
e	HDWT-T341	Bracket, Alcove Offset	4		
Also available in Stainless Steel - HDWT-S0287				\$ 72.00	

NOTE: Torx bits are not included but can be ordered separately.

Prices subject to change without notice.
Items may be changed or discontinued
without notice and without incurring obligation.

Effective Date April 1, 2018

Additional Kits

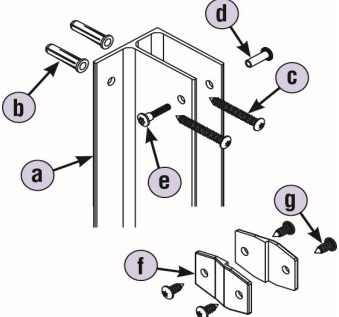
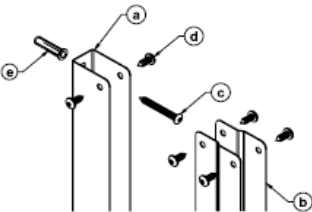
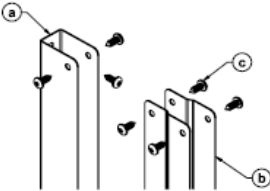
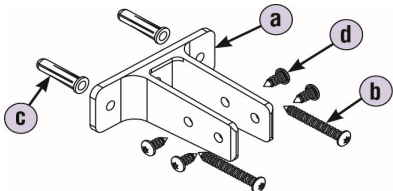
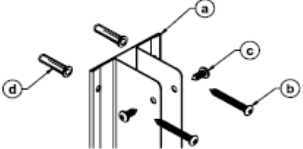
Ending Alcove Panel Kit (Aluminum Continuous)	HDWT-A0289	List Price																							
	Includes:	\$ 82.00																							
	<table border="1"> <thead> <tr> <th>Part No.</th> <th>Description</th> <th>Qty.</th> </tr> </thead> <tbody> <tr> <td>a</td> <td>HDWT-A183 Bracket, Continuous, 1" Single-Ear Aluminum</td> <td>1</td> </tr> <tr> <td>b</td> <td>FAST-T373 Anchor - Plastic #14-16 x 1 3/8" Lg.</td> <td>10</td> </tr> <tr> <td>c</td> <td>FAST-P002 Screw #14 x 2" BTN Sheet Metal Torx-T27 w/Pin SS</td> <td>10</td> </tr> <tr> <td>d</td> <td>FAST-P003 Screw #10-24 x 3/4" BTN Barrel-Female Torx-T27 w/Pin SS</td> <td>5</td> </tr> <tr> <td>e</td> <td>FAST-P004 Screw #10-24 x 3/4" BTN Step-Male Torx-T27 SS</td> <td>5</td> </tr> <tr> <td>f</td> <td>HDWT-T341 Bracket, Alcove Offset</td> <td>4</td> </tr> <tr> <td>g</td> <td>FAST-Z0016 Screw #14 x 5/8" Sheet Metal Torx-T27 w/Pin ZP</td> <td>8</td> </tr> </tbody> </table>	Part No.	Description	Qty.	a	HDWT-A183 Bracket, Continuous, 1" Single-Ear Aluminum	1	b	FAST-T373 Anchor - Plastic #14-16 x 1 3/8" Lg.	10	c	FAST-P002 Screw #14 x 2" BTN Sheet Metal Torx-T27 w/Pin SS	10	d	FAST-P003 Screw #10-24 x 3/4" BTN Barrel-Female Torx-T27 w/Pin SS	5	e	FAST-P004 Screw #10-24 x 3/4" BTN Step-Male Torx-T27 SS	5	f	HDWT-T341 Bracket, Alcove Offset	4	g	FAST-Z0016 Screw #14 x 5/8" Sheet Metal Torx-T27 w/Pin ZP	8
Part No.	Description	Qty.																							
a	HDWT-A183 Bracket, Continuous, 1" Single-Ear Aluminum	1																							
b	FAST-T373 Anchor - Plastic #14-16 x 1 3/8" Lg.	10																							
c	FAST-P002 Screw #14 x 2" BTN Sheet Metal Torx-T27 w/Pin SS	10																							
d	FAST-P003 Screw #10-24 x 3/4" BTN Barrel-Female Torx-T27 w/Pin SS	5																							
e	FAST-P004 Screw #10-24 x 3/4" BTN Step-Male Torx-T27 SS	5																							
f	HDWT-T341 Bracket, Alcove Offset	4																							
g	FAST-Z0016 Screw #14 x 5/8" Sheet Metal Torx-T27 w/Pin ZP	8																							
NOTE: Torx bits are not included but can be ordered separately.																									
Dividing/Ending Alcove Panel @Wall Kit (Stainless Continuous)	HDWT-S0477-57	List Price																							
	Includes:	\$ 131.00																							
	<table border="1"> <thead> <tr> <th>Part No.</th> <th>Description</th> <th>Qty.</th> </tr> </thead> <tbody> <tr> <td>a</td> <td>S190-02-57 Bracket "U" Continuous 2" X 57"</td> <td>1</td> </tr> <tr> <td>b</td> <td>HDWT-S0290-57 Bracket Continuous Alcove Offset</td> <td>2</td> </tr> <tr> <td>c</td> <td>FAST-P002 Screw #14 X 2" BTN Sheet Metal Torx-T27 w/Pin SS</td> <td>5</td> </tr> <tr> <td>d</td> <td>FAST-S355A Screw 1/4-14 X 5/8" Sheet Metal Torx-T27 w/Pin SS</td> <td>30</td> </tr> <tr> <td>e</td> <td>FAST-T373 Anchor - Plastic #14-16 X 1-3/8" Lg.</td> <td>5</td> </tr> </tbody> </table>	Part No.	Description	Qty.	a	S190-02-57 Bracket "U" Continuous 2" X 57"	1	b	HDWT-S0290-57 Bracket Continuous Alcove Offset	2	c	FAST-P002 Screw #14 X 2" BTN Sheet Metal Torx-T27 w/Pin SS	5	d	FAST-S355A Screw 1/4-14 X 5/8" Sheet Metal Torx-T27 w/Pin SS	30	e	FAST-T373 Anchor - Plastic #14-16 X 1-3/8" Lg.	5						
Part No.	Description	Qty.																							
a	S190-02-57 Bracket "U" Continuous 2" X 57"	1																							
b	HDWT-S0290-57 Bracket Continuous Alcove Offset	2																							
c	FAST-P002 Screw #14 X 2" BTN Sheet Metal Torx-T27 w/Pin SS	5																							
d	FAST-S355A Screw 1/4-14 X 5/8" Sheet Metal Torx-T27 w/Pin SS	30																							
e	FAST-T373 Anchor - Plastic #14-16 X 1-3/8" Lg.	5																							
Dividing/Ending Alcove Panel @Panel Kit (Stainless Continuous)	HDWT-S0478-57	List Price																							
	Includes:	\$ 131.00																							
	<table border="1"> <thead> <tr> <th>Part No.</th> <th>Description</th> <th>Qty.</th> </tr> </thead> <tbody> <tr> <td>a</td> <td>S190-02-57 Bracket "U" Continuous 2" X 57"</td> <td>1</td> </tr> <tr> <td>b</td> <td>HDWT-S0290-57 Bracket Continuous Alcove Offset</td> <td>2</td> </tr> <tr> <td>c</td> <td>FAST-S355A Screw 1/4-14 X 5/8" Sheet Metal Torx-T27 w/Pin SS</td> <td>35</td> </tr> </tbody> </table>	Part No.	Description	Qty.	a	S190-02-57 Bracket "U" Continuous 2" X 57"	1	b	HDWT-S0290-57 Bracket Continuous Alcove Offset	2	c	FAST-S355A Screw 1/4-14 X 5/8" Sheet Metal Torx-T27 w/Pin SS	35												
Part No.	Description	Qty.																							
a	S190-02-57 Bracket "U" Continuous 2" X 57"	1																							
b	HDWT-S0290-57 Bracket Continuous Alcove Offset	2																							
c	FAST-S355A Screw 1/4-14 X 5/8" Sheet Metal Torx-T27 w/Pin SS	35																							
Urinal Screen Bracket Kit	HDWT-Z5US	List Price																							
	Includes:	\$ 29.00																							
	<table border="1"> <thead> <tr> <th>Part No.</th> <th>Description</th> <th>Qty.</th> </tr> </thead> <tbody> <tr> <td>a</td> <td>HDWT-T335 Bracket, Double-Ear x 1" x 3 1/2"</td> <td>2</td> </tr> <tr> <td>b</td> <td>FAST-Z002 Screw #14 x 2" Sheet Metal Torx-T27 w/Pin ZP</td> <td>4</td> </tr> <tr> <td>c</td> <td>FAST-T373 Anchor - Plastic #14-16 x 1 3/8" Lg.</td> <td>4</td> </tr> <tr> <td>d</td> <td>FAST-Z0016 Screw #14 x 5/8" Sheet Metal Torx-T27 w/Pin ZP</td> <td>8</td> </tr> </tbody> </table>	Part No.	Description	Qty.	a	HDWT-T335 Bracket, Double-Ear x 1" x 3 1/2"	2	b	FAST-Z002 Screw #14 x 2" Sheet Metal Torx-T27 w/Pin ZP	4	c	FAST-T373 Anchor - Plastic #14-16 x 1 3/8" Lg.	4	d	FAST-Z0016 Screw #14 x 5/8" Sheet Metal Torx-T27 w/Pin ZP	8									
Part No.	Description	Qty.																							
a	HDWT-T335 Bracket, Double-Ear x 1" x 3 1/2"	2																							
b	FAST-Z002 Screw #14 x 2" Sheet Metal Torx-T27 w/Pin ZP	4																							
c	FAST-T373 Anchor - Plastic #14-16 x 1 3/8" Lg.	4																							
d	FAST-Z0016 Screw #14 x 5/8" Sheet Metal Torx-T27 w/Pin ZP	8																							
Also available in Stainless Steel - HDWT-S5US		\$ 53.00																							
NOTE: Torx bits are not included but can be ordered separately.																									
Urinal Screen Bracket Kit (Stainless Continuous)	HDWT-S0482-47	List Price																							
	Includes:	\$ 84.00																							
	<table border="1"> <thead> <tr> <th>Part No.</th> <th>Description</th> <th>Qty.</th> </tr> </thead> <tbody> <tr> <td>a</td> <td>HDWT-S186-47 Bracket "2 Ear" Continuous 1" X 47"</td> <td>1</td> </tr> <tr> <td>b</td> <td>FAST-P002 Screw #14 X 2" BTN Sheet Metal Torx-T27 w/Pin SS</td> <td>8</td> </tr> <tr> <td>c</td> <td>FAST-S355A Screw 1/4-14 X 5/8" Sheet Metal Torx-T27 w/Pin SS</td> <td>8</td> </tr> <tr> <td>d</td> <td>FAST-T373 Anchor - Plastic #14-16 X 1-3/8" Lg.</td> <td>8</td> </tr> </tbody> </table>	Part No.	Description	Qty.	a	HDWT-S186-47 Bracket "2 Ear" Continuous 1" X 47"	1	b	FAST-P002 Screw #14 X 2" BTN Sheet Metal Torx-T27 w/Pin SS	8	c	FAST-S355A Screw 1/4-14 X 5/8" Sheet Metal Torx-T27 w/Pin SS	8	d	FAST-T373 Anchor - Plastic #14-16 X 1-3/8" Lg.	8									
Part No.	Description	Qty.																							
a	HDWT-S186-47 Bracket "2 Ear" Continuous 1" X 47"	1																							
b	FAST-P002 Screw #14 X 2" BTN Sheet Metal Torx-T27 w/Pin SS	8																							
c	FAST-S355A Screw 1/4-14 X 5/8" Sheet Metal Torx-T27 w/Pin SS	8																							
d	FAST-T373 Anchor - Plastic #14-16 X 1-3/8" Lg.	8																							
Also Available in 41" Height - HDWT-S0482-41		\$ 74.00																							

Prices subject to change without notice.
Items may be changed or discontinued
without notice and without incurring obligation.

Effective Date April 1, 2018

Additional Kits

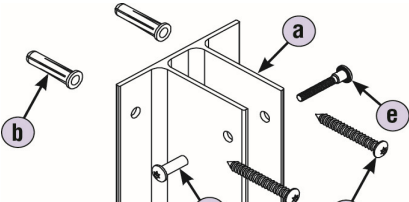
	HDWT-A0057			List Price
	Includes:			\$ 83.00
	Part No.	Description	Qty.	
a	HDWT-A186-42	Bracket, Continuous Double-Ear Aluminum	1	
b	FAST-T373	Anchor - Plastic #14-16 x 1 3/8" Lg.	10	
c	FAST-P002	Screw #14 x 2" BTN Sheet Metal Torx-T27 w/Pin SS	10	
d	FAST-P003	Screw #10-24 x 3/4" BTN Barrel-Female Torx-T27 w/Pin SS	5	
e	FAST-P004	Screw #10-24 x 3/4" BTN Step-Male Torx-T27 SS	5	

NOTE: Torx bits are not included but can be ordered separately.

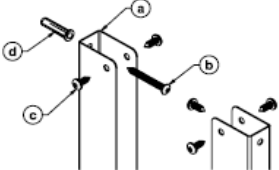
	HDWT-S0475-47			List Price
	Includes:			\$ 137.00
	Part No.	Description	Qty.	
a	S190-02-47	Bracket "U" Continuous 2" X 47"	2	
b	FAST-P002	Screw #14 X 2" BTN Sheet Metal Torx-T27 w/Pin SS	4	
c	FAST-S355A	Screw 1/4-14 X 5/8" Sheet Metal Torx-T27 w/Pin SS	20	
d	FAST-T373	Anchor - Plastic #14-16 X 1-3/8" Lg.	4	
Also Available in 41" Height - HDWT-S0475-41				\$ 120.00

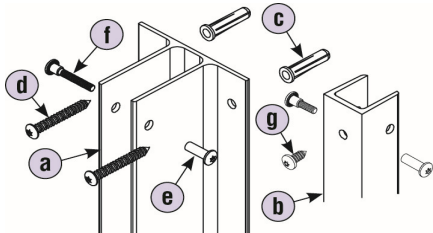
	HDWT-A0142			List Price
	Includes:			\$ 165.00
	Part No.	Description	Qty.	
a	HDWT-A186-42	Bracket, Continuous Double-Ear Aluminum	1	
b	HDWT-A185-42	Bracket, Continuous "U" Aluminum	1	
c	FAST-T373	Anchor - Plastic #14-16 x 1 3/8" Lg.	10	
d	FAST-P002	Screw #14 x 2" BTN Sheet Metal Torx-T27 w/Pin SS	10	
e	FAST-P003	Screw #10-24 x 3/4" BTN Barrel-Female Torx-T27 w/Pin SS	5	
f	FAST-P004	Screw #10-24 x 3/4" BTN Step-Male Torx-T27 SS	5	
g	FAST-S355A	Screw 1/4-14 x 5/8" Sheet Metal Torx-T27 w/Pin SS	5	

NOTE: Torx bits are not included but can be ordered separately.

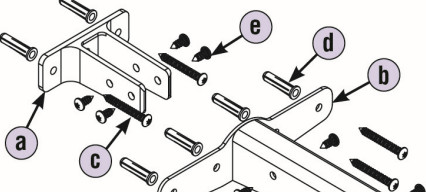
	HDWT-Z6US			List Price
	Includes:			\$ 32.00
	Part No.	Description	Qty.	
a	HDWT-T335	Bracket, Double-Ear x 1" x 3 1/2"	1	
b	HDWT-Z270	Wing Bracket	1	
c	FAST-Z002	Screw #14 x 2" Sheet Metal Torx-T27 w/Pin ZP	6	
d	FAST-T373	Anchor - Plastic #14-16 x 1 3/8" Lg.	6	
e	FAST-Z0016	Screw #14 x 5/8" Sheet Metal Torx-T27 w/Pin ZP	8	

NOTE: Torx bits are not included but can be ordered separately.

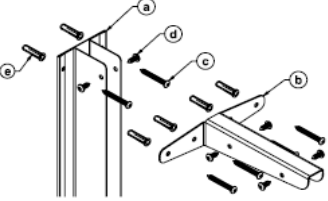
	HDWT-S0486-47			List Price
	Includes:			\$ 121.00
	Part No.	Description	Qty.	
a	HDWT-S186-46	Bracket "2 Ear" Continuous 1" X 46"	1	
b	HDWT-S0487	"Wing" Bracket 1" X 8"	1	
c	FAST-P002	Screw #14 X 2" BTN Sheet Metal Torx-T27 w/Pin SS	12	
d	FAST-S355A	Screw 1/4-14 X 5/8" Sheet Metal Torx-T27 w/Pin SS	12	
e	FAST-T373	Anchor - Plastic #14-16 X 1-3/8" Lg.	12	
Also Available in 41" Height - HDWT-S0486-41				\$ 108.00

Prices subject to change without notice.
Items may be changed or discontinued
without notice and without incurring obligation.

Effective Date April 1, 2018

Additional Kits

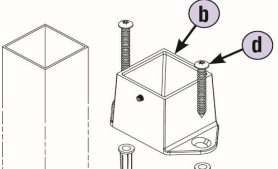
Floor-To-Ceiling 1 1/4" Aluminum Post with Shoes		HDWT-Z0194	List Price	
		Includes:		
			\$ 103.00	
		Part No.	Description	Qty.
		a	T462-120 Aluminum Post 120"	1
		b	HDWT-T284 Shoe for 1 1/4" Aluminum Post	2
c	FAST-T373 Anchor - Plastic #14-16 x 1 3/8" Lg.	4		
d	FAST-Z002 Screw #14 x 2" Sheet Metal Torx-T27 w/Pin ZP	4		

NOTE: Torx bits are not included but can be ordered separately.

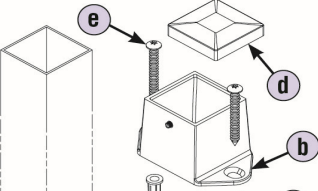
Floor-Braced 1 1/4" Aluminum Post w/Shoes and Cap		HDWT-Z0195	List Price	
		Includes:		
		\$ 72.00		
		Part No.	Description	Qty.
		a	T462-060 Aluminum Post 60"	1
		b	HDWT-T284 Shoe for 1 1/4" Aluminum Post	1
		c	FAST-T373 Anchor - Plastic #14-16 x 1 3/8" Lg.	2
d	HDWT-T181 Cap for 1 1/4" Aluminum Post	1		
e	FAST-Z002 Screw #14 x 2" Sheet Metal Torx-T27 w/Pin ZP	2		

NOTE: Torx bits are not included but can be ordered separately.

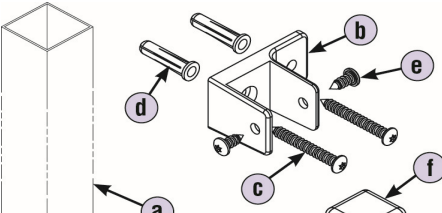
Wall Front Post 1 1/4" Sq. x 58"		HDWT-Z0388-XXXX	List Price	
		Includes:		
		\$ 53.00		
		Part No.	Description	Qty.
		a	T463-058-XXXX Post 1 1/4" Sq. x 58"	1
		b	HDWT-Z0037 Bracket, Mini-Ear 1 1/4" x 1 1/4"	3
		c	FAST-Z002 Screw #14 x 2" Sheet Metal Torx-T27 w/Pin ZP	6
		d	FAST-T373 Anchor - Plastic #14-16 x 1 3/8" Lg.	6
		e	FAST-Z0016 Screw #14 x 5/8" Sheet Metal Torx-T27 w/Pin ZP	6
f	HDWT-P0386 Cap Plug 1 1/4" Sq.	2		

NOTE: Torx bits are not included but can be ordered separately.

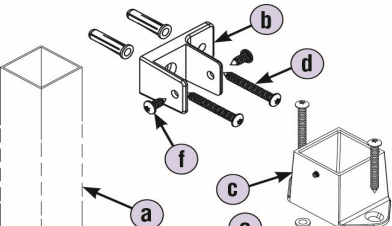
Wall Front Post Kit 1/4" Sq. x 82"		HDWT-Z0396-XXXX	List Price	
		Includes:		
		\$ 78.00		
		Part No.	Description	Qty.
		a	T463-082-XXXX Post 1 1/4" Sq. x 82"	1
		b	HDWT-Z0037 Bracket, Mini-Ear 1 1/4" x 1 1/4"	3
		c	HDWT-Z0394 Post Shoe 1 1/4" Sq.	1
		d	FAST-Z002 Screw #14 x 2" Sheet Metal Torx-T27 w/Pin ZP	8
e	FAST-T373 Anchor - Plastic #14-16 x 1 3/8" Lg.	8		
f	FAST-Z0016 Screw #14 x 5/8" Sheet Metal Torx-T27 w/Pin ZP	6		

NOTE: Torx bits are not included but can be ordered separately.

Effective Date April 1, 2018

Additional Kits

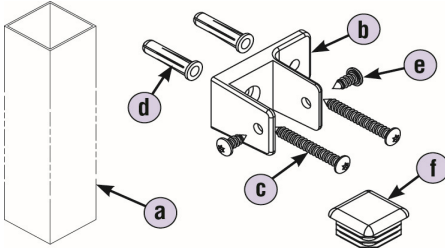
Wall Front Post 1 1/4" Sq. x 58" (Stn. Steel)	HDWT-Z0388-0177	List Price																											
	Includes:																												
	<table border="1"> <thead> <tr> <th></th> <th>Part No.</th> <th>Description</th> <th>Qty.</th> </tr> </thead> <tbody> <tr> <td>a</td> <td>T463-058-0177</td> <td>Post 1 1/4" Sq. x 58" Dusk Gray</td> <td>1</td> </tr> <tr> <td>b</td> <td>HDWT-Z0037</td> <td>Bracket, Mini-Ear 1 1/4" x 1 1/4"</td> <td>3</td> </tr> <tr> <td>c</td> <td>FAST-Z002</td> <td>Screw #14 x 2" Sheet Metal Torx-T27 w/Pin ZP</td> <td>6</td> </tr> <tr> <td>d</td> <td>FAST-T373</td> <td>Anchor - Plastic #14-16 x 1 3/8" Lg.</td> <td>6</td> </tr> <tr> <td>e</td> <td>FAST-Z0016</td> <td>Screw #14 x 5/8" Sheet Metal Torx-T27 w/Pin ZP</td> <td>6</td> </tr> <tr> <td>f</td> <td>HDWT-P0386</td> <td>Cap Plug 1 1/4" Sq.</td> <td>2</td> </tr> </tbody> </table>		Part No.	Description	Qty.	a	T463-058-0177	Post 1 1/4" Sq. x 58" Dusk Gray	1	b	HDWT-Z0037	Bracket, Mini-Ear 1 1/4" x 1 1/4"	3	c	FAST-Z002	Screw #14 x 2" Sheet Metal Torx-T27 w/Pin ZP	6	d	FAST-T373	Anchor - Plastic #14-16 x 1 3/8" Lg.	6	e	FAST-Z0016	Screw #14 x 5/8" Sheet Metal Torx-T27 w/Pin ZP	6	f	HDWT-P0386	Cap Plug 1 1/4" Sq.	2
	Part No.	Description	Qty.																										
a	T463-058-0177	Post 1 1/4" Sq. x 58" Dusk Gray	1																										
b	HDWT-Z0037	Bracket, Mini-Ear 1 1/4" x 1 1/4"	3																										
c	FAST-Z002	Screw #14 x 2" Sheet Metal Torx-T27 w/Pin ZP	6																										
d	FAST-T373	Anchor - Plastic #14-16 x 1 3/8" Lg.	6																										
e	FAST-Z0016	Screw #14 x 5/8" Sheet Metal Torx-T27 w/Pin ZP	6																										
f	HDWT-P0386	Cap Plug 1 1/4" Sq.	2																										
NOTE: Torx bits are not included but can be ordered separately.																													

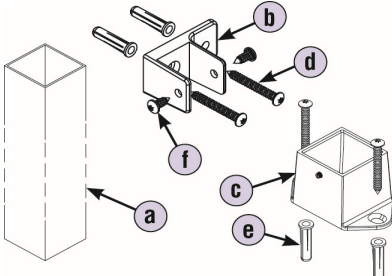
Wall Front Post Kit 1 1/4" Sq. x 82" (Stn. Steel)	HDWT-Z0396-0177	List Price																											
	Includes:																												
	<table border="1"> <thead> <tr> <th></th> <th>Part No.</th> <th>Description</th> <th>Qty.</th> </tr> </thead> <tbody> <tr> <td>a</td> <td>T463-082-0177</td> <td>Post 1 1/4" Sq. x 82" Dusk Gray</td> <td>1</td> </tr> <tr> <td>b</td> <td>HDWT-Z0037</td> <td>Bracket, Mini-Ear 1 1/4" x 1 1/4"</td> <td>3</td> </tr> <tr> <td>c</td> <td>HDWT-Z0394</td> <td>Post Shoe 1 1/4" Sq.</td> <td>1</td> </tr> <tr> <td>d</td> <td>FAST-Z002</td> <td>Screw #14 x 2" Sheet Metal Torx-T27 w/Pin ZP</td> <td>8</td> </tr> <tr> <td>e</td> <td>FAST-T373</td> <td>Anchor - Plastic #14-16 x 1 3/8" Lg.</td> <td>8</td> </tr> <tr> <td>f</td> <td>FAST-Z0016</td> <td>Screw #14 x 5/8" Sheet Metal Torx-T27 w/Pin ZP</td> <td>6</td> </tr> </tbody> </table>		Part No.	Description	Qty.	a	T463-082-0177	Post 1 1/4" Sq. x 82" Dusk Gray	1	b	HDWT-Z0037	Bracket, Mini-Ear 1 1/4" x 1 1/4"	3	c	HDWT-Z0394	Post Shoe 1 1/4" Sq.	1	d	FAST-Z002	Screw #14 x 2" Sheet Metal Torx-T27 w/Pin ZP	8	e	FAST-T373	Anchor - Plastic #14-16 x 1 3/8" Lg.	8	f	FAST-Z0016	Screw #14 x 5/8" Sheet Metal Torx-T27 w/Pin ZP	6
	Part No.	Description	Qty.																										
a	T463-082-0177	Post 1 1/4" Sq. x 82" Dusk Gray	1																										
b	HDWT-Z0037	Bracket, Mini-Ear 1 1/4" x 1 1/4"	3																										
c	HDWT-Z0394	Post Shoe 1 1/4" Sq.	1																										
d	FAST-Z002	Screw #14 x 2" Sheet Metal Torx-T27 w/Pin ZP	8																										
e	FAST-T373	Anchor - Plastic #14-16 x 1 3/8" Lg.	8																										
f	FAST-Z0016	Screw #14 x 5/8" Sheet Metal Torx-T27 w/Pin ZP	6																										
NOTE: Torx bits are not included but can be ordered separately.																													

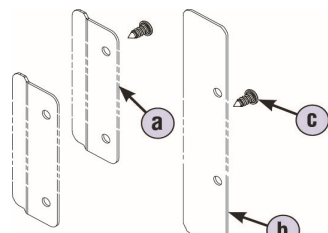
No-Site Strips, Latch and Hinge Sides (NST1)	HDWT-S0421	List Price															
	Includes:																
	<table border="1"> <thead> <tr> <th></th> <th>Part No.</th> <th>Description</th> <th>Qty.</th> </tr> </thead> <tbody> <tr> <td>a</td> <td>HDWT-S0419</td> <td>No-Site Strip, Latch Side 1-3/4"W x 26-1/2"H</td> <td>2</td> </tr> <tr> <td>b</td> <td>HDWT-S0420</td> <td>No-Site Strip, Hinge Side 1-3/8"W x 50"H</td> <td>1</td> </tr> <tr> <td>c</td> <td>FAST-S355A</td> <td>Screw 1/4-14 x 5/8" Sheet Metal Torx-T27 w/Pin SS</td> <td>12</td> </tr> </tbody> </table>		Part No.	Description	Qty.	a	HDWT-S0419	No-Site Strip, Latch Side 1-3/4"W x 26-1/2"H	2	b	HDWT-S0420	No-Site Strip, Hinge Side 1-3/8"W x 50"H	1	c	FAST-S355A	Screw 1/4-14 x 5/8" Sheet Metal Torx-T27 w/Pin SS	12
	Part No.	Description	Qty.														
a	HDWT-S0419	No-Site Strip, Latch Side 1-3/4"W x 26-1/2"H	2														
b	HDWT-S0420	No-Site Strip, Hinge Side 1-3/8"W x 50"H	1														
c	FAST-S355A	Screw 1/4-14 x 5/8" Sheet Metal Torx-T27 w/Pin SS	12														
NOTE: Torx bits are not included but can be ordered separately.																	

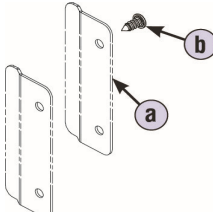
No-Site Strips, Latch Side (NST2)	HDWT-S0422	List Price											
	Includes:												
	<table border="1"> <thead> <tr> <th></th> <th>Part No.</th> <th>Description</th> <th>Qty.</th> </tr> </thead> <tbody> <tr> <td>a</td> <td>HDWT-S0419</td> <td>No-Site Strip, Latch Side 1-3/4"W x 26-1/2"H</td> <td>2</td> </tr> <tr> <td>b</td> <td>FAST-S355A</td> <td>Screw 1/4-14 x 5/8" Sheet Metal Torx-T27 w/Pin SS</td> <td>8</td> </tr> </tbody> </table>		Part No.	Description	Qty.	a	HDWT-S0419	No-Site Strip, Latch Side 1-3/4"W x 26-1/2"H	2	b	FAST-S355A	Screw 1/4-14 x 5/8" Sheet Metal Torx-T27 w/Pin SS	8
	Part No.	Description	Qty.										
a	HDWT-S0419	No-Site Strip, Latch Side 1-3/4"W x 26-1/2"H	2										
b	FAST-S355A	Screw 1/4-14 x 5/8" Sheet Metal Torx-T27 w/Pin SS	8										
NOTE: Torx bits are not included but can be ordered separately.													

Effective Date April 1, 2018

Additional Kits

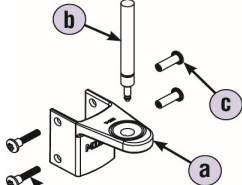
Top Hinge Kit 	HDWT-T100			List Price
	Includes:			\$ 18.00
	Part No.	Description	Qty.	
	a	HDWT-T101 Top Hinge with Bushing	1	
	b	HDWT-T103 Pin, Top Hinge	1	
	c	FAST-Z003 Screw #10-24 x 3/4" Barrel-Female Torx-T27 w/Pin ZP	2	
	d	FAST-Z004A Screw #10-24 x 1" Step-Male Torx-T27 w/Pin ZP	2	
	Also available in Stainless Steel - HDWT-S100			\$ 26.00

NOTE: Torx bits are not included but can be ordered separately.

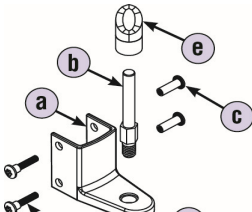
Bottom Hinge Kit 	HDWT-T110			List Price
	Includes:			\$ 18.00
	Part No.	Description	Qty.	
	a	HDWT-T112 Bottom Hinge	1	
	b	HDWT-T113 Pin, Bottom Hinge	1	
	c	FAST-Z003 Screw #10-24 x 3/4" Barrel-Female Torx-T27 w/Pin ZP	2	
	d	FAST-Z004A Screw #10-24 x 1" Step-Male Torx-T27 w/Pin ZP	2	
	e	HDWT-T211 Cam, Bottom Hinge	1	
	f	HDWT-T118 3/8"-16 Locknut, Bottom Hinge	1	
	Also available in Stainless Steel - HDWT-S110			\$ 26.00

NOTE: Torx bits are not included but can be ordered separately.

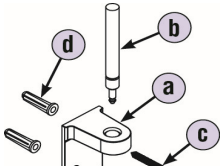
Flat Top Hinge Kit 	HDWT-S0185			List Price
	Includes:			\$ 40.00
	Part No.	Description	Qty.	
	a	HDWT-S0149 Top Hinge Flat with Bushing SS	1	
	b	HDWT-T103 Pin, Top Hinge	1	
	c	FAST-S0023 Screw #10 x 2" FL Sheet Metal Torx-T25 w/Pin SS	2	
	d	FAST-T381 Anchor - Plastic #10-12 x 1" Lg.	2	

NOTE: Torx bits are not included but can be ordered separately.

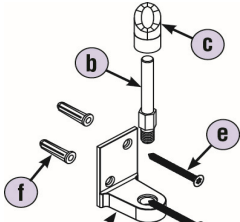
Flat Bottom Hinge Kit 	HDWT-S0186			List Price
	Includes:			\$ 40.00
	Part No.	Description	Qty.	
	a	HDWT-S0150 Bottom Hinge Flat SS	1	
	b	HDWT-T113 Pin, Bottom Hinge	1	
	c	HDWT-T211 Cam, Bottom Hinge	1	
	d	HDWT-T118 3/8"-16 Locknut, Bottom Hinge	1	
	e	FAST-S0023 Screw #10 x 2" FL Sheet Metal Torx-T25 w/Pin SS	2	
	f	FAST-T381 Anchor - Plastic #10-12 x 1" Lg.	2	

NOTE: Torx bits are not included but can be ordered separately.

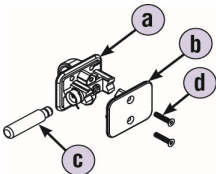
Door Latch 	HDWT-T290			List Price
	Includes:			\$ 11.00
	Part No.	Description	Qty.	
	a	HDWT-T291 Hardware Kit - Latch Assembly	1	
	b	HDWT-T299 Front Plate (chrome-plated)	1	
	c	HDWT-T301 Latch Bolt	1	
	d	FAST-T300 Screw 5-40 x 3/8" Flat Head Sheet Metal Torx-T10 ZP	2	
	Also available in Stainless Steel - HDWT-S290			\$ 21.00

NOTE: Torx bits are not included but can be ordered separately.

Prices subject to change without notice.
Items may be changed or discontinued without notice and without incurring obligation.

Effective Date April 1, 2018

Additional Kits

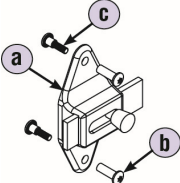
	Surface-Mounted Door Latch		HDWT-Z0189	List Price
	Includes:			\$ 20.00
		Part No.	Description	Qty.
	a	HDWT-Z0124	Latch, Slide Surface-Mount ZP	1
	b	FAST-Z003	Screw #10-24 x 3/4" Barrel-Female Torx-T27 w/Pin ZP	2
	c	FAST-Z004	Screw #10-24 x 3/4" Step-Male Torx-T27 ZP	2
Also available in Stainless Steel - HDWT-S0189				\$ 34.00
NOTE: Torx bits are not included but can be ordered separately.				

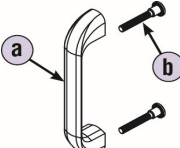
	Door Pull Kit		HDWT-Z0138	List Price
	Includes:			\$ 17.00
		Part No.	Description	Qty.
	a	HDWT-Z282	Door Pull ZP	1
	b	FAST-Z0003	Screw #10-24 x 1 1/2" Step-Male Torx-T27 w/Pin ZP	2
Also available in Stainless Steel - HDWT-S0138				\$ 30.00
NOTE: Torx bits are not included but can be ordered separately.				

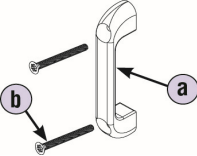
	Door Pull with Countersink Kit		HDW0-Z0168	List Price
	Includes:			\$ 20.00
		Part No.	Description	Qty.
	a	HDW0-Z0167	Door Pull with Countersink ZP	1
	b	FAST-Z0027	Screw #10-24 x 2" Flat Machine Torx ZP	2
Also available in Stainless Steel - HDW0-S0168				\$ 24.00
NOTE: Torx bits are not included but can be ordered separately.				

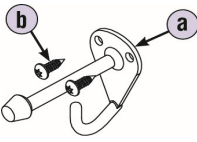
	Coat Hook Inswing Kit		HDWT-Z0011	List Price
	Includes:			\$ 17.00
		Part No.	Description	Qty.
	a	HDWT-Z285	Coat Hook with Bumper ZP	1
	b	FAST-Z0019	Screw #10 x 5/8" Sheet Metal Torx-T27 w/Pin ZP	2
Also available in Stainless Steel - HDWT-S0011				\$ 18.00
NOTE: Torx bits are not included but can be ordered separately.				

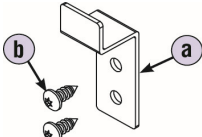
	Coat Hook Outswing Kit		HDWT-S0013	List Price
	Includes:			\$ 17.00
		Part No.	Description	Qty.
	a	HDWT-S275	Coat Hook, Outswing	1
	b	FAST-S355A	Screw 1/4-14 x 5/8" Sheet Metal Torx-T27 w/Pin SS	2
NOTE: Torx bits are not included but can be ordered separately.				

	Wall Bumper Kit		HDWT-Z283	List Price
	Includes:			\$ 13.00
		Part No.	Description	Qty.
	a	HDWT-Z177	Wall Bumper ZP	1
	b	FAST-Z0019	Screw #10 x 5/8" Sheet Metal Torx-T27 w/Pin ZP	2
Also available in Stainless Steel - HDWT-S283				\$ 23.00
NOTE: Torx bits are not included but can be ordered separately.				

Prices subject to change without notice.
Items may be changed or discontinued
without notice and without incurring obligation.

Effective Date April 1, 2018

Additional Kits

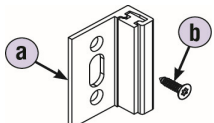
	HDWT-Z319		List Price	
	Includes:		\$ 40.00	
		Part No.	Description	Qty.
	a	HDWT-Z0022	Flat Strike/Keeper Inswing & Outswing	1
	b	FAST-Z0006	Screw #10 x 3/4" FL Sheet Metal Torx-T25 w/Pin ZP	2
Also available in Stainless Steel - HDWT-S319			\$ 42.00	

NOTE: Torx bits are not included but can be ordered separately.

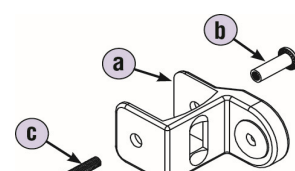
	HDWT-T318		List Price	
	Includes:		\$ 16.00	
		Part No.	Description	Qty.
	a	HDWT-Z0119	Wrap Around Strike/Keeper	1
	b	FAST-Z003	Screw #10-24 x 3/4" Barrel-Female Torx-T27 w/Pin ZP	1
	c	FAST-Z004A	Screw #10-24 x 1" Step-Male Torx-T27 w/Pin ZP	1
Also available in Stainless Steel - HDWT-S318			\$ 37.00	

NOTE: Torx bits are not included but can be ordered separately.

	HDWT-Z0190		List Price	
	Includes:		\$ 22.00	
		Part No.	Description	Qty.
	a	HDWT-Z0125	Strike/Keeper Inswing ZP	1
	b	FAST-Z003	Screw #10-24 x 3/4" Barrel-Female Torx-T27 w/Pin ZP	2
	c	FAST-Z004A	Screw #10-24 x 1" Step-Male Torx-T27 w/Pin ZP	2
Also available in Stainless Steel - HDWT-S0190			\$ 32.00	

NOTE: Torx bits are not included but can be ordered separately.

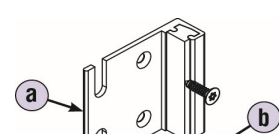
	HDWT-Z0191		List Price	
	Includes:		\$ 21.00	
		Part No.	Description	Qty.
	a	HDWT-Z0127	Flat Strike/Keeper Inswing ZP	1
	b	FAST-Z0006	Screw #10 x 3/4" FL Sheet Metal Torx-T25 w/Pin ZP	2
Also available in Stainless Steel - HDWT-S0191			\$ 29.00	

NOTE: Torx bits are not included but can be ordered separately.

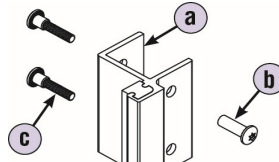
	HDWT-Z0192		List Price	
	Includes:		\$ 19.00	
		Part No.	Description	Qty.
	a	HDWT-Z0126	Strike/Keeper Outswing ZP	1
	b	FAST-Z003	Screw #10-24 x 3/4" Barrel-Female Torx-T27 w/Pin ZP	2
	c	FAST-Z004A	Screw #10-24 x 1" Step-Male Torx-T27 w/Pin ZP	2
Also available in Stainless Steel - HDWT-S0192			\$ 27.00	

NOTE: Torx bits are not included but can be ordered separately.

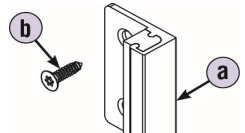
	HDWT-Z0193		List Price	
	Includes:		\$ 16.00	
		Part No.	Description	Qty.
	a	HDWT-Z0128	Flat Strike/Keeper Inswing ZP	1
	b	FAST-Z0006	Screw #10 x 3/4" FL Sheet Metal Torx-T25 w/Pin ZP	2
Also available in Stainless Steel - HDWT-S0193			\$ 26.00	

NOTE: Torx bits are not included but can be ordered separately.

Prices subject to change without notice.
Items may be changed or discontinued
without notice and without incurring obligation.

Effective Date April 1, 2018

Additional Kits

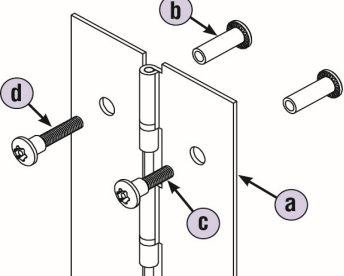
Continuous Stainless Steel Piano Hinge (spring-loaded)			List Price																
			HDWT-S0136 (RHI/LHO) Includes: <table border="1"> <thead> <tr> <th>Part No.</th> <th>Description</th> <th>Qty.</th> </tr> </thead> <tbody> <tr> <td>a</td> <td>HDWT-S0208 Piano Hinge, Continuous Stainless Steel</td> <td>1</td> </tr> <tr> <td>b</td> <td>FAST-P003 Screw #10-24 x 3/4" BTN Barrel-Female Torx-T27 w/Pin SS</td> <td>12</td> </tr> <tr> <td>c</td> <td>FAST-P004 Screw #10-24 x 3/4" BTN Step-Male Torx-T27 SS</td> <td>6</td> </tr> <tr> <td>d</td> <td>FAST-P004A Screw #10-24 x 1" Shoulder Torx-T27 SS</td> <td>6</td> </tr> </tbody> </table>	Part No.	Description	Qty.	a	HDWT-S0208 Piano Hinge, Continuous Stainless Steel	1	b	FAST-P003 Screw #10-24 x 3/4" BTN Barrel-Female Torx-T27 w/Pin SS	12	c	FAST-P004 Screw #10-24 x 3/4" BTN Step-Male Torx-T27 SS	6	d	FAST-P004A Screw #10-24 x 1" Shoulder Torx-T27 SS	6	\$ 122.00
			Part No.	Description	Qty.														
a	HDWT-S0208 Piano Hinge, Continuous Stainless Steel	1																	
b	FAST-P003 Screw #10-24 x 3/4" BTN Barrel-Female Torx-T27 w/Pin SS	12																	
c	FAST-P004 Screw #10-24 x 3/4" BTN Step-Male Torx-T27 SS	6																	
d	FAST-P004A Screw #10-24 x 1" Shoulder Torx-T27 SS	6																	
HDWT-S0137 (LHI/RHO) Includes: <table border="1"> <thead> <tr> <th>Part No.</th> <th>Description</th> <th>Qty.</th> </tr> </thead> <tbody> <tr> <td>a</td> <td>HDWT-S0209 Piano Hinge, Continuous Stainless Steel</td> <td>1</td> </tr> <tr> <td>b</td> <td>FAST-P003 Screw #10-24 x 3/4" BTN Barrel-Female Torx-T27 w/Pin SS</td> <td>12</td> </tr> <tr> <td>c</td> <td>FAST-P004 Screw #10-24 x 3/4" BTN Step-Male Torx-T27 SS</td> <td>6</td> </tr> <tr> <td>d</td> <td>FAST-P004A Screw #10-24 x 1" Shoulder Torx-T27 SS</td> <td>6</td> </tr> </tbody> </table>			Part No.	Description	Qty.	a	HDWT-S0209 Piano Hinge, Continuous Stainless Steel	1	b	FAST-P003 Screw #10-24 x 3/4" BTN Barrel-Female Torx-T27 w/Pin SS	12	c	FAST-P004 Screw #10-24 x 3/4" BTN Step-Male Torx-T27 SS	6	d	FAST-P004A Screw #10-24 x 1" Shoulder Torx-T27 SS	6	\$ 122.00	
Part No.	Description	Qty.																	
a	HDWT-S0209 Piano Hinge, Continuous Stainless Steel	1																	
b	FAST-P003 Screw #10-24 x 3/4" BTN Barrel-Female Torx-T27 w/Pin SS	12																	
c	FAST-P004 Screw #10-24 x 3/4" BTN Step-Male Torx-T27 SS	6																	
d	FAST-P004A Screw #10-24 x 1" Shoulder Torx-T27 SS	6																	

NOTE: Torx bits are not included but can be ordered separately.

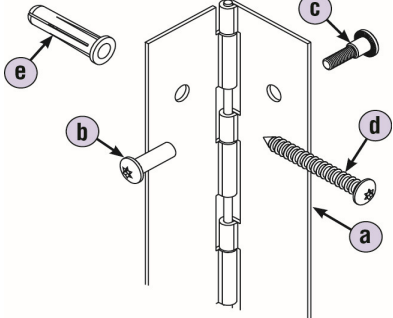
Continuous Stainless Steel Piano Hinge at Wall (spring-loaded)			List Price																			
			HDWT-S0197 (RHI/LHO) Includes: <table border="1"> <thead> <tr> <th>Part No.</th> <th>Description</th> <th>Qty.</th> </tr> </thead> <tbody> <tr> <td>a</td> <td>HDWT-S0208 Piano Hinge, Continuous Stainless Steel</td> <td>1</td> </tr> <tr> <td>b</td> <td>FAST-P003 Screw #10-24 x 3/4" BTN Barrel-Female Torx-T27 w/Pin SS</td> <td>6</td> </tr> <tr> <td>c</td> <td>FAST-P004 Screw #10-24 x 3/4" BTN Step-Male Torx-T27 SS</td> <td>6</td> </tr> <tr> <td>d</td> <td>FAST-P002 Screw #14 x 2" BTN Sheet Metal Torx-T27 w/Pin SS</td> <td>6</td> </tr> <tr> <td>e</td> <td>FAST-T373 Anchor - Plastic #14-16 x 1 1/8" Lg.</td> <td>6</td> </tr> </tbody> </table>	Part No.	Description	Qty.	a	HDWT-S0208 Piano Hinge, Continuous Stainless Steel	1	b	FAST-P003 Screw #10-24 x 3/4" BTN Barrel-Female Torx-T27 w/Pin SS	6	c	FAST-P004 Screw #10-24 x 3/4" BTN Step-Male Torx-T27 SS	6	d	FAST-P002 Screw #14 x 2" BTN Sheet Metal Torx-T27 w/Pin SS	6	e	FAST-T373 Anchor - Plastic #14-16 x 1 1/8" Lg.	6	\$ 120.00
			Part No.	Description	Qty.																	
a	HDWT-S0208 Piano Hinge, Continuous Stainless Steel	1																				
b	FAST-P003 Screw #10-24 x 3/4" BTN Barrel-Female Torx-T27 w/Pin SS	6																				
c	FAST-P004 Screw #10-24 x 3/4" BTN Step-Male Torx-T27 SS	6																				
d	FAST-P002 Screw #14 x 2" BTN Sheet Metal Torx-T27 w/Pin SS	6																				
e	FAST-T373 Anchor - Plastic #14-16 x 1 1/8" Lg.	6																				
HDWT-S0198 (LHI/RHO) Includes: <table border="1"> <thead> <tr> <th>Part No.</th> <th>Description</th> <th>Qty.</th> </tr> </thead> <tbody> <tr> <td>a</td> <td>HDWT-S0209 Piano Hinge, Continuous Stainless Steel</td> <td>1</td> </tr> <tr> <td>b</td> <td>FAST-P003 Screw #10-24 x 3/4" BTN Barrel-Female Torx-T27 w/Pin SS</td> <td>6</td> </tr> <tr> <td>c</td> <td>FAST-P004 Screw #10-24 x 3/4" BTN Step-Male Torx-T27 SS</td> <td>6</td> </tr> <tr> <td>d</td> <td>FAST-P002 Screw #14 x 2" BTN Sheet Metal Torx-T27 w/Pin SS</td> <td>6</td> </tr> <tr> <td>e</td> <td>FAST-T373 Anchor - Plastic #14-16 x 1 1/8" Lg.</td> <td>6</td> </tr> </tbody> </table>			Part No.	Description	Qty.	a	HDWT-S0209 Piano Hinge, Continuous Stainless Steel	1	b	FAST-P003 Screw #10-24 x 3/4" BTN Barrel-Female Torx-T27 w/Pin SS	6	c	FAST-P004 Screw #10-24 x 3/4" BTN Step-Male Torx-T27 SS	6	d	FAST-P002 Screw #14 x 2" BTN Sheet Metal Torx-T27 w/Pin SS	6	e	FAST-T373 Anchor - Plastic #14-16 x 1 1/8" Lg.	6	\$ 120.00	
Part No.	Description	Qty.																				
a	HDWT-S0209 Piano Hinge, Continuous Stainless Steel	1																				
b	FAST-P003 Screw #10-24 x 3/4" BTN Barrel-Female Torx-T27 w/Pin SS	6																				
c	FAST-P004 Screw #10-24 x 3/4" BTN Step-Male Torx-T27 SS	6																				
d	FAST-P002 Screw #14 x 2" BTN Sheet Metal Torx-T27 w/Pin SS	6																				
e	FAST-T373 Anchor - Plastic #14-16 x 1 1/8" Lg.	6																				

NOTE: Torx bits are not included but can be ordered separately.

Effective Date April 1, 2018

Additional Kits

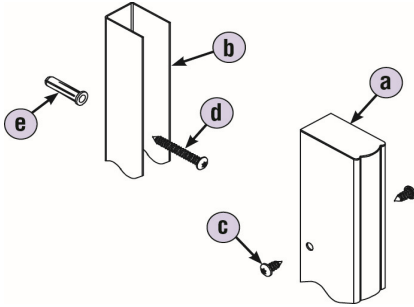
Telescoping Pilaster Kit		List Price	
			
HDWT-T1971-XXXX (adjustable from 1½" to 1⅞")		\$ 112.00	
Includes:			
	Part No.	Description	Qty.
a	T197-01A-XXXX	Telescoping Channel	1
b	T197-01B-XXXX	Mounting Channel	1
c	FAST-Z0016	Screw #14 x ⅝" Sheet Metal Torx-T27 w/Pin ZP	8
d	FAST-Z002	Screw #14 x 2" Sheet Metal Torx-T27 w/Pin ZP	4
e	FAST-T373	Anchor - Plastic #14-16 x 1⅜" Lg.	4
Also available in Stainless Steel - HDWT-S1971		\$ 155.00	
Also available in Textured Stainless Steel - HDWT-S1971-5WL / LTH		\$ 180.00	
HDWT-T1972-XXXX (adjustable from 1⅞" to 2½")		\$ 117.00	
Includes:			
	Part No.	Description	Qty.
a	T197-02A-XXXX	Telescoping Channel	1
b	T197-02B-XXXX	Mounting Channel	1
c	FAST-Z0016	Screw #14 x ⅝" Sheet Metal Torx-T27 w/Pin ZP	8
d	FAST-Z002	Screw #14 x 2" Sheet Metal Torx-T27 w/Pin ZP	4
e	FAST-T373	Anchor - Plastic #14-16 x 1⅜" Lg.	4
Also available in Stainless Steel - HDWT-S1972		\$ 182.00	
Also available in Textured Stainless Steel - HDWT-S1972-5WL / LTH		\$ 201.00	
HDWT-T1973-XXXX (adjustable from 2½" to 3½")		\$ 124.00	
Includes:			
	Part No.	Description	Qty.
a	T197-03A-XXXX	Telescoping Channel	1
b	T197-03B-XXXX	Mounting Channel	1
c	FAST-Z0016	Screw #14 x ⅝" Sheet Metal Torx-T27 w/Pin ZP	8
d	FAST-Z002	Screw #14 x 2" Sheet Metal Torx-T27 w/Pin ZP	4
e	FAST-T373	Anchor - Plastic #14-16 x 1⅜" Lg.	4
Also available in Stainless Steel - HDWT-S1973		\$ 190.00	
Also available in Textured Stainless Steel - HDWT-S1973-5WL / LTH		\$ 231.00	

NOTE: Torx bits are not included but can be ordered separately.

XXXX = Color

Effective Date April 1, 2018

Additional Kits

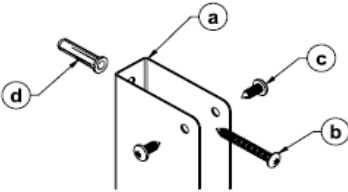
Pilaster Channel Kit		List Price
		
HDWT-T0495-XXXX		
Includes:		\$ 69.00
	Part No.	Description
a	T192-02-57-XXXX	Bracket "U" Continuous 2" X 57"
b	FAST-P002	Screw #14 X 2" BTN Sheet Metal Torx-T27 w/Pin SS
c	FAST-S355A	Screw 1/4-14 X 5/8" Sheet Metal Torx-T27 w/Pin SS
d	FAST-T373	Anchor - Plastic #14-16 X 1-3/8" Lg.
Also Available in Stainless Steel - HDWT-S0495		\$ 78.00
Also Available in Textured Stainless Steel - HDWT-S0495-5WL / LTH		\$ 90.00
HDWT-T0497-XXXX		\$ 73.00
Includes:		
	Part No.	Description
a	T192-03-57-XXXX	Bracket "U" Continuous 3" X 57"
b	FAST-P002	Screw #14 X 2" BTN Sheet Metal Torx-T27 w/Pin SS
c	FAST-S355A	Screw 1/4-14 X 5/8" Sheet Metal Torx-T27 w/Pin SS
d	FAST-T373	Anchor - Plastic #14-16 X 1-3/8" Lg.
Also Available in Stainless Steel - HDWT-S0497		\$ 87.00
Also Available in Textured Stainless Steel - HDWT-S0497-5WL / LTH		\$ 104.00

XXXX = Color

Effective Date April 1, 2018

Additional Kits

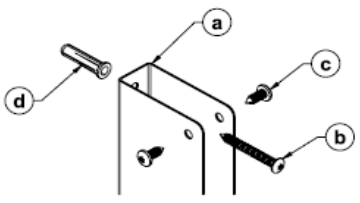
Panel Channel Kit		List Price
		
HDWT-T0489-XXXX		
Includes:		\$ 68.00
	Part No.	Description
a	T190-02-57-XXXX	Bracket "U" Continuous 2" X 57"
b	FAST-P002	Screw #14 X 2" BTN Sheet Metal Torx-T27 w/Pin SS
c	FAST-S355A	Screw 1/4-14 X 5/8" Sheet Metal Torx-T27 w/Pin SS
d	FAST-T373	AnchorR - Plastic #14-16 X 1-3/8" Lg.
Also Available in Stainless Steel - HDWT-S0489		\$ 74.00
Also Available in Textured Stainless Steel - HDWT-S0489-5WL / LTH		\$ 84.00
HDWT-T0491-XXXX		\$ 72.00
Includes:		
	Part No.	Description
a	T190-03-57-XXXX	Bracket "U" Continuous 3" X 57"
b	FAST-P002	Screw #14 X 2" BTN Sheet Metal Torx-T27 w/Pin SS
c	FAST-S355A	Screw 1/4-14 X 5/8" Sheet Metal Torx-T27 w/Pin SS
d	FAST-T373	Anchor - Plastic #14-16 X 1-3/8" Lg.
Also Available in Stainless Steel - HDWT-S0491		\$ 86.00
Also Available in Textured Stainless Steel - HDWT-S0491-5WL / LTH		\$ 98.00

XXXX = Color

Effective Date April 1, 2018

Additional Kits

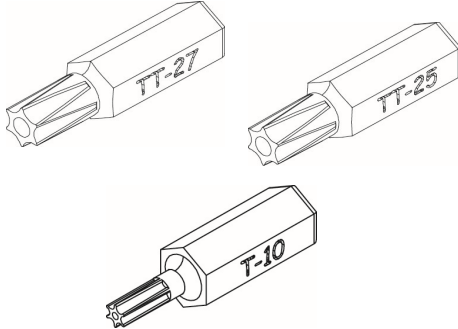
Torx Bits				
	Part No.	Description	Qty.	List Price
	HW101031	Torx Bit T27	1	\$ 5.30
	HW101030	Torx Bit T25	1	\$ 5.30
	HW0037	Torx Bit T10	1	\$ 5.30

Curtain Hook for Headrail	HDWP-COMHK	List Price
		\$ 2.10

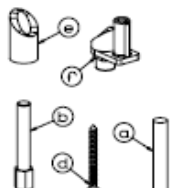

Cam & Hinge Pin Kit	HDWT-Z0079	List Price
	Includes:	
		Part No. Description Qty. \$
	a	HDWT-T103 Pin, Top Hinge 1 14.00
	b	HDWT-T113 Pin, Bottom Hinge 1
	c	HDWT-T118 3/8-16 Lock Nut, Bottom Hinge 1
	d	FAST-T352 Screw #10X2 FL Sheet Metal Phillips Dr ZP 1
	e	HDWT-T211 Cam, Bottom Hinge 1
f	HDWT-P117 Cam, Door 1	

Paint (1-oz. Touch-Up)	HDWT-T342	List Price
	Available In the Following Colors:	\$ 14.00
	Code No. Color	
	7053 Adaptive Shade	
	2103 Almond	
	0250 Black	
	6128 Blonde	
	1029 Buff	
	0410 Burgundy	
	2145 Carnival Red	
	1412 Coffee	
	7076 Cyberspace	
	2125 Dove Gray	
	6479 Drizzle	
	0177 Dusk Gray	
	0180 Fawn	
	0550 Glacier Blue	
	6467 Kendal Green	
	0386 Polo Green	
	0260 Royal Blue	
	6423 Ryegrass	
	8517 Toffee	
	0412 Warm Gray	
	0750 White	

Prices subject to change without notice.
Items may be changed or discontinued
without notice and without incurring obligation.