



TEL: 800.BRADLEY
FAX: 262.251.5817
bradleycorp.com

Washroom Accessories Service Parts List Price Book 0610WSP

Effective Date June 1, 2010

Table of Contents

Hair-Hand Dryers (Models 2870 thru 2874, 2889, 2896, & 2897)	2
Hand Dryers (Models 2875-28 & 2885-28, 2877-28 & 2887-28)	3
Aerix Hand Dryer (Series 2902-28, 2903-28, 2904-28, & 2905-2873)	4
Waste Receptacles, Waste Receptacle Liners ***	5
Napkin-Tampon Vendors (Models 401, 4017, 4018, 403, 407, 426 & 428)	6
Napkin Vendors (Models 402 & 427 manufactured after August 1993)	7
Toilet Tissue Dispensers (Models 5402, 5412 & 5422) ***	8
Back Clamp and Spindles for Toilet Tissue Dispensers ***	8
Soap Dispensers (Models 6542 & 6562; 1993 and later) ***	9
Soap Drawers and Soap Trays	9
Soap Dispensers (Models 6322, 6324 & 6326; 1993 and later) 6334***	10
Automatic Soap Dispenser (Model 6315)	11
Grab Bar Couplings, Retaining Bracket for Shower Seats	12
Post Sets for Towel Bars, Towel Dispenser Accessories	13
Miscellaneous Parts	13
Shower Curtain Flanges, Diaper Changing Stations, Miscellaneous	14
Mirror Glass, Medicine Cabinet Replacement Shelves	15
Lock & Cam Part Number Reference ***	16
Kit Reference Guide ***	17

*** USE KIT NUMBERS TO ORDER PARTS

Effective Date June 1, 2010

Hair/Hand Dryers - Cast Iron

Models 2870 Thru 2874, 2889, 2896, & 2897

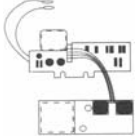
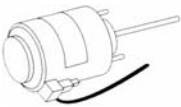
		Part No.	Description	Quantity	List Price
		P15-317	Motor - 115 Volt	1	\$ 334.30
		P15-318	Motor - 208/230 Volt	1	\$ 346.40
		P15-319+	Heating Element - 115 Volt - 20AMP	1	\$ 85.00
		P15-320+	Heating Element - 230 Volt - 10.5AMP	1	\$ 92.80
		P15-346+	Heating Element - 208 Volt - 11 AMP	1	\$ 85.00
		P15-298	Screw - Surface Cover	1	\$ 3.00
		P15-316	Screw - Recessed Cover	1	\$ 5.20
		P15-304	Allen Wrench	1	\$ 10.30
		P15-301**+	Timer - 115 Volt - 30 SEC - 60HZ	1	\$ 187.00
		P15-302**+	Timer - 208/230 Volt - 30 SEC - 60HZ	1	\$ 187.00
		P15-321**+	Timer - 115 Volt - 80 SEC - 60HZ	1	\$ 170.00
		P15-322**+	Timer - 208/230 Volt - 80 SEC - 60HZ	1	\$ 170.00
		P15-335**+	Timer - 230 Volt - 30 SEC - 50HZ	1	\$ 170.00
		P15-336**+	Timer - 230 Volt - 80 SEC - 50HZ	1	\$ 170.00
		P15-300	Fuse Block Assembly	1	\$ 12.90
		P15-299	Fuse - 2AMP Glass	1	\$ 3.00
		P15-323**	Push Button Assembly	1	\$ 63.50
		P15-324**	Push Button Spring Kit	1	\$ 7.70
		P15-325	Brushes - GE w/Black Cartridge	1	\$ 28.90
		P15-326	Brushes - GE w/White Cartridge	1	\$ 37.00
Cover - Model 2870 (Surface-Mounted)					
		P15-342	White	1	\$ 515.00
Cover - Model 2871					
		P15-331A	White	1	\$ 562.50
Cover - Model 2872					
		P15-359A	White	1	\$ 562.50
Cover - Model 2873					
		P15-330A	White	1	\$ 515.00
Cover - Model 2874					
		P15-358A	White	1	\$ 515.00
		P15-347	Switch Only (Open Blade Type)	1	\$ 67.00
		P15-348	Micro Switch Only	1	\$ 67.00
		P15-351	Push Button Adaptor & Bearing Kit	1	\$ 36.10
		P15-353	Inlet Grill, Brackets & Rivets (Surface Vandal Resistant)	1	\$ 52.90
		P15-354	Inlet Grill, Brackets & Rivets (Recessed Standard)	1	\$ 54.10

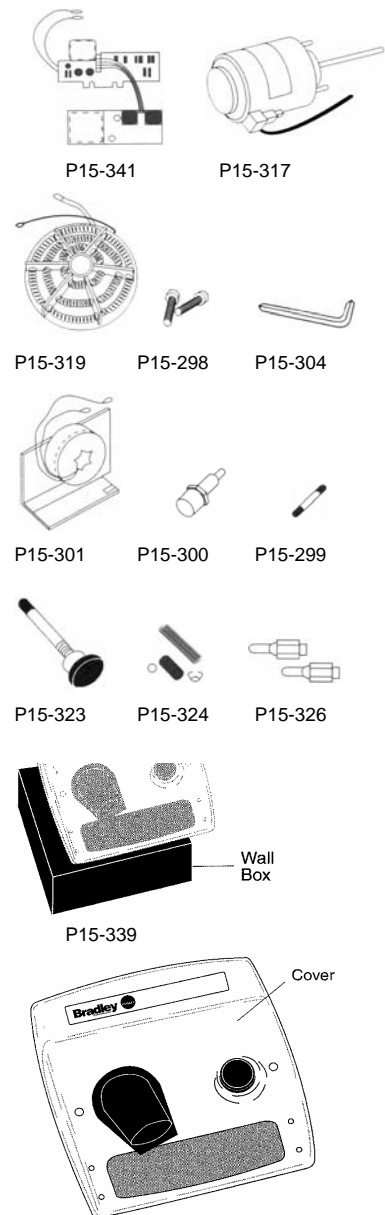

NOTE: Cover includes nozzle and push button.
P15-331A

* Models 2870

** Models 2871 thru 2874









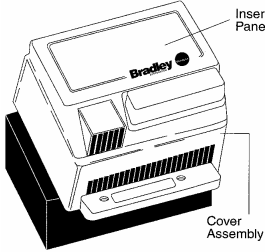
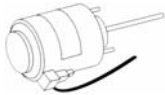

+ Models need Serial Number when ordering replacement parts.

+Please have the serial number located on the outside of the cover at hand when ordering service parts to ensure the correct parts are being ordered.

Effective Date June 1, 2010

Hand Dryers

Models 2875 & 2885, 2877 & 2887

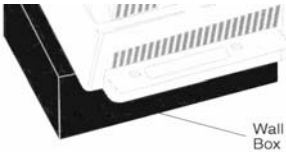
	Part No.	Description	Quantity	List Price
 <p>P15-315A</p>  <p>P15-305</p>  <p>P15-306</p>  <p>P15-310</p>  <p>P15-298</p>  <p>P15-300</p>  <p>P15-299</p>  <p>P15-301</p>  <p>P15-313</p>  <p>P15-337</p>  <p>P15-304</p>  <p>P15-340</p>	P15-315A	Insert Panel - Snow White	1	\$ 69.40
	P15-315D	Insert Panel - Country Beige	1	\$ 69.40
	P15-315M	Insert Panel - Chrome	1	\$ 69.40
	P15-328+	Cover Assembly - Satin Chrome Finish	1	\$ 513.10
	P15-329+	Cover Assembly - White Finish	1	\$ 376.00
	P15-309	Blower Wheel - 4-3/4" Dia.	1	\$ 30.90
	P15-305+	Motor Kit - 120 Volt - 60HZ	1	\$ 212.60
	P15-307+	Motor Kit - 208/240 Volt - 60HZ	1	\$ 212.60
	P15-306+	Capacitor 120 Volt	1	\$ 56.70
	P15-308+	Capacitor 208/240 Volt	1	\$ 56.70
	P15-310+	Heating Element - 120 Volt	1	\$ 73.70
	P15-311+	Heating Element - 208 Volt	1	\$ 67.00
	P15-333+	Heating Element - 220 Volt	1	\$ 67.00
	P15-298	Screw - Cover	1	\$ 3.00
	P15-300	Fuse Holder - Glass Fuse	1	\$ 12.90
	P15-299	Fuse - 2AMP	1	\$ 3.00
	P15-301+	Timer - 120 Volt - 30 SEC - 60HZ	1	\$ 187.00
	P15-302+	Timer - 208/240 Volt - 30 SEC - 60HZ	1	\$ 187.00
	P15-321+	Timer - 120 Volt - 80 SEC - 60HZ	1	\$ 170.00
	P15-322+	Timer - 208/240 Volt - 80 SEC - 60HZ	1	\$ 170.00
P15-335+	Timer - 220/240 Volt - 30 SEC - 50HZ	1	\$ 170.00	
P15-336+	Timer - 220/240 Volt - 80 SEC - 50HZ	1	\$ 170.00	
P15-313	Pushbutton Assembly	1	\$ 48.50	
P15-337	Spring & Bumper Kit	1	\$ 7.70	
P15-304	Allen Wrench	1	\$ 10.30	

+ Models need Serial Number when ordering replacement parts.

+Please have the serial number located on the outside of the cover at hand when ordering service parts to ensure the correct parts are being ordered.

Effective Date June 1, 2010

Hand Dryers

Models 2902-28, 2902-2873, and 2902-2874

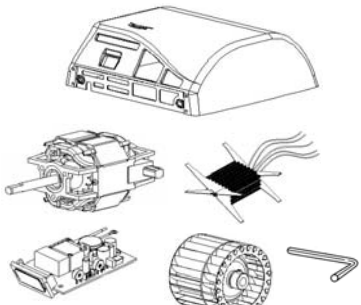
	Part No.	Description	Quantity	List Price
2902-28 Series 	P15-411	Cast Iron Cover - White	1	\$ 425.00
	P15-412	Steel Cover - White	1	\$ 375.00
	P15-413	Stainless Steel Cover - Satin	1	\$ 400.00
	P15-414	Motor	1	\$ 315.00
	P15-415	Heating Element	1	\$ 90.00
	P15-416	Sensor Set	1	\$ 190.00
	P15-417	Motor Brushes	1	\$ 35.00
	P15-418	Turbine	1	\$ 50.00
	P15-419	Wrench	1	\$ 10.00
	P15-444	Rubber Cushions / Silent Blocks	1	\$ 4.00
	P15-445	Sensor Window	1	\$ 15.00
	P15-446	Motor Spring	1	\$ 6.00

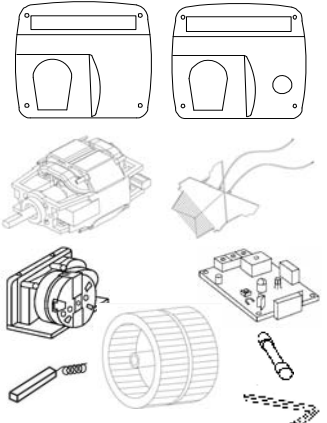
2903-28 and 2904-28 Series 	P15-420	Cast Iron Cover, Sensored - White	1	\$ 500.00
	P15-421	Cast Iron Cover, Push Button - White	1	\$ 500.00
	P15-422	Motor - UL	1	\$ 300.00
	P15-423	Motor - CE	1	\$ 325.00
	P15-424	Heating Element - UL	1	\$ 75.00
	P15-425	Heating Element - CE	1	\$ 80.00
	P15-426	Timer - UL	1	\$ 165.00
	P15-427	Timer - CE	1	\$ 170.00
	P15-428	Sensor Set - UL	1	\$ 175.00
	P15-429	Sensor Set - CE	1	\$ 180.00
	P15-417	Motor Brushes	1	\$ 35.00
	P15-430	Fan Wheel	1	\$ 25.00
	P15-431	Fuse - UL	1	\$ 3.00
	P15-419	Wrench	1	\$ 10.00
	P15-444	Rubber Cushions / Silent Blocks	1	\$ 4.00
	P15-446	Motor Spring	1	\$ 6.00
	P15-447	Sensor Cable	1	\$ 10.00

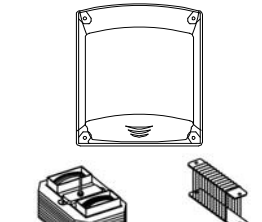
2905-2873 Series 	P15-433	Steel Cover - White	1	\$ 200.00
	P15-434	Motor - UL and Fan Wheel	1	\$ 70.00
	P15-435	Motor - CE and Fan Wheel	1	\$ 75.00
	P15-436	Heating Element - UL	1	\$ 40.00
	P15-437	Heating Element - CE	1	\$ 45.00
	P15-438	Sensor Set - UL	1	\$ 135.00
	P15-439	Sensor Set - CE	1	\$ 140.00
	P15-440	Fan Wheel	1	\$ 20.00
	P15-441	Wrench	1	\$ 10.00

Need Serial Number when ordering replacement parts.

Please have the serial number located on the outside of the cover at hand when ordering service parts to ensure the correct parts are being ordered.

Effective Date June 1, 2010

Waste Receptacles

Molded Plastic & Stainless Steel Waste Receptacles

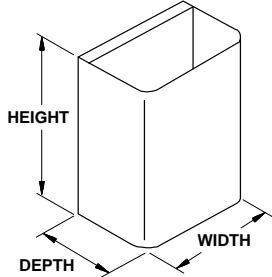

STAINLESS STEEL

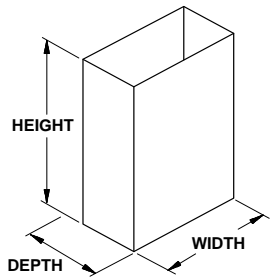

MOLDED PLASTIC

Part No.	* Used On Models	Size (Inches)			Gallons	List Price
		Width	Height	Depth		
P11-028	P 2017, 2018, 2227, 2228, 2252	10-3/4	20	5-1/4	4.9	\$ 58.90
M44-005	P 2027, 2028	10-3/4	20	3-1/2	3.3	\$ 45.80
P11-037	P 2037, 2038	14-1/4	26	7	11.2	\$ 55.10
P11-025	P 225, 2257, 2258, 315, 3157, 3158	10-3/4	38	5-1/4	9.2	\$ 72.10
P11-034	P 2251	10-3/4	38	3	5.3	\$ 32.50
S03-011000000	S 227, 2271, 236-36, 237-36, 334	15	23	12-3/4	18	\$ 219.50
700-505	S 229	11-15/16	6	4	1.25	\$ 71.40
A05-005	S 2291	11-15/16	9-1/16	3-15/16	2	\$ 53.50
P11-035	P 2297, 2298	11-15/16	9-1/16	3-9/16	1.7	\$ 28.00
S03-005000000	S 234-35, 237, 344, 346	15	23	8-3/4	12	\$ 212.20
S03-005650000	S 234-65	15	23	8-3/4	12	\$ 204.00
A05-012000000	S 234, 235 (after 1/02)	15	23	8-3/4	12	\$ 164.70
P11-027	P 235, 2357, 2358	14	23	3-1/2	4.9	\$ 50.30
P11-036	P 238, 238-10, 238-1027, 238-11, 238-27, 238-35	14	23	5-7/8	8.2	\$ 33.00
M44-006	P 3251, 3257, 3258	10-3/4	17	3-1/2	2.8	\$ 45.80
A05-007	S 4721.4722	10-1/2	9-1/16	3-15/16	1.5	\$ 48.40
S01-415	S 4731	10-11/16	9-1/16	4	1.5	\$ 50.30
P11-032	P 591, 5911,	8	10-3/4	3-5/8	0.9	\$ 25.00
P11-031	P 5912, 594, 5942	8	8	3-5/8	1.0	\$ 38.10
M44-048	P 593, 5931, 5932	14	8	3-1/2	1.7	\$ 62.20
P11-038	P 2277	14-1/4	9-3/4	17-3/8	10.5	\$ 33.00
P15-025	S 377 Swing Top Only	13	7	13	n/a	\$ 252.40
P15-098	S 377- 36 Swing Top Only	15	8	15	n/a	\$ 255.00
P15-195	S 377- 38 Swing Top Only	19	10	19	n/a	\$ 287.40

* P = Plastic, S = Stainless Steel

Waste Receptacle Liners

PVC Vinyl Liners and Waxed Paper Liners

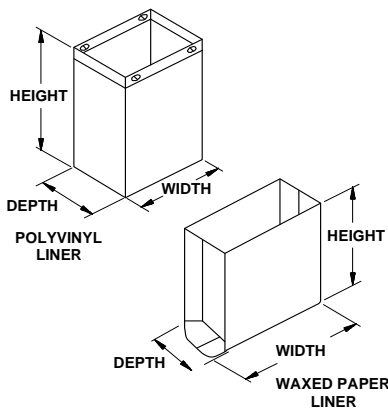

Part No.	Used On Models	Size (Inches)			Kit Part Number	List Price
		Width	Height	Depth		
PVC Vinyl						
P11-001	227, 2271, 234-36, 237-36, 334, 336	14	23	11-3/4		\$ 18.75
P11-004	233, 234, 237, 344, 346	14-3/4	23	7		\$ 18.30
P11-005	355	16	23	12		\$ 18.30
P11-006	356	18	23	9		\$ 18.95
P11-007	357	13-1/2	18	5-1/2		\$ 17.50
P20-134	Instructions					\$ 0.10
Waxed						
P11-030	2258, 359, 403, 428, 4721, 4722, 4727, 4731, 4737, 4738, 4781, 4791, 591, 5911, 5912, 594, 5942	9	11	4	P11-022	\$ 225.00

 Prices subject to change without notice.
 Items may be changed or discontinued
 without notice and without incurring obligation.

Effective Date June 1, 2010

Napkin/Tampon Vendors

Models 401, 4017, 4018, 403, 407, 426 & 428

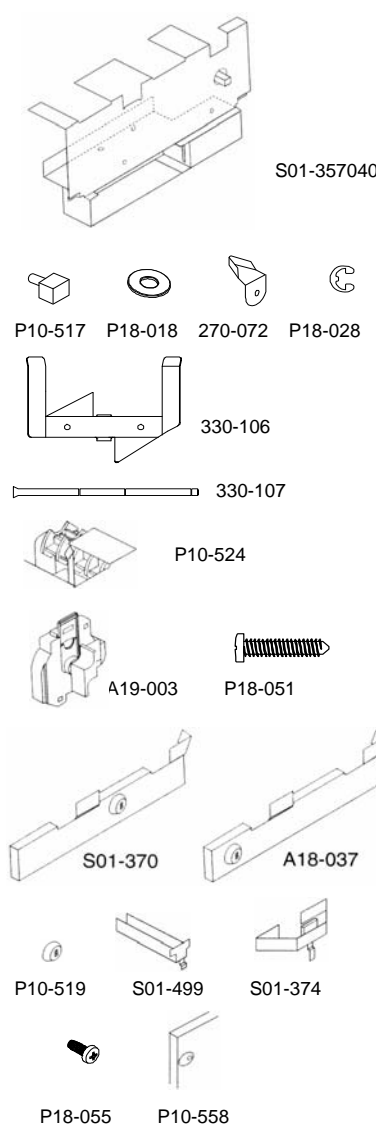
	Part No.	Description	List Price
 <p>S01-357040</p> <p>P10-517 P18-018 270-072 P18-028</p> <p>330-106</p> <p>330-107</p> <p>P10-524</p> <p>A19-003 P18-051</p> <p>S01-370 A18-037</p> <p>P10-519 S01-499 S01-374</p> <p>P18-055 P10-558</p>	S01-357040*	Free Coin Mounting Plate Assembly	\$ 214.40
	S01-357042*	10¢ Coin Mounting Plate Assembly	\$ 214.40
	S01-357043*	50¢ Coin Mounting Plate Assembly	\$ 214.40
	S01-357044*	\$1 Coin Mounting Plate Assembly	\$ 214.40
	S01-357045*	25¢ Coin Mounting Plate Assembly	\$ 214.40
	P10-517	Slave Shaft (Recommend also purchasing P18-028)	\$ 3.80
	P18-018	Flat Washer	\$ 0.50
	270-072	Cam	\$ 4.40
	P18-028	Retaining Ring	\$ 0.70
	330-106	Napkin Paddle	\$ 6.90
	330-107	Coined Shaft (Recommend also purchasing P18-028)	\$ 7.10
	P10-524	Tampon Rotor	\$ 9.70
	A19-003***	Free Coin Mechanism Assembly	\$ 63.95
	A19-005***	10¢ Coin Mechanism Assembly	\$ 63.95
	A19-006***	25¢ Coin Mechanism Assembly	\$ 63.95
	A19-007***	50¢ Coin Mechanism Assembly	\$ 63.95
	A19-013***	\$1 Coin Mechanism Assembly	\$ 55.60
	M44-074	Coin Mechanism Handle	\$ 25.00
	P18-051	Screw	\$ 0.30
	S01-370**	Coin Box Cover & Lock Assembly (for units manufactured before 1993)	\$ 30.15
A18-037**	Coin Box Cover & Lock Assembly (for units manufactured after 1993)	\$ 20.90	
P10-519	Lock for Coin Box	\$ 6.60	
P10-548	Key for Coin Box	\$ 8.65	
S01-499	Tampon Weight Assembly	\$ 13.15	
S01-374	Napkin Weight Assembly	\$ 14.65	
P20-034	Free Label	\$ 0.90	
P20-036	10¢ Label	\$ 0.90	
P20-037	25¢ Label	\$ 1.05	
P20-078	50¢ Label	\$ 0.90	
P20-117	\$1 Label	\$ 0.90	
P18-055	Screw	\$ 0.60	
P10-558****	Lock for Door	P15-399	
P10-526****	Key for Door	P15-398	
P20-039	Maintenance and Loading Instructions	\$ 0.70	

Includes items P10-517 thru A18-037.

** Includes items P10-519 & P10-548.







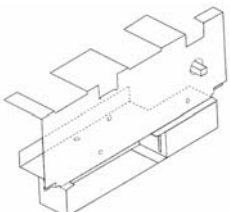

*** Includes items P18-051 & label.

**** Refer to Lock & Cam Part No. Reference for Kit No.

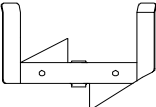
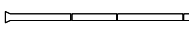
Effective Date June 1, 2010

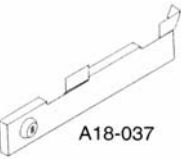
Napkin Vendors

Models 402 & 427 (Manufactured after August 1993)

	Part No.	Description	List Price
 <p>S01-361040</p>	S01-361040*	Free Coin Mounting Plate Assembly	\$ 146.30
	S01-361042*	10¢ Coin Mounting Plate Assembly	\$ 146.30
	S01-361045*	25¢ Coin Mounting Plate Assembly	\$ 146.30
	S01-361043*	50¢ Coin Mounting Plate Assembly	\$ 146.30
	S01-361044*	\$1 Coin Mounting Plate Assembly	\$ 146.30
	P10-517**	Slave Shaft	\$ 3.80
	P18-018	Flat Washer	\$ 0.50
	270-072	Cam	\$ 4.40
	P18-028	Retaining Ring	\$ 0.70
	330-106	Napkin Paddle	\$ 6.90
 <p>P10-517 P18-018 270-072 P18-028</p>	330-107**	Coined Shaft	\$ 7.10
	A19-003***	Free Coin Mechanism Assembly	\$ 63.95
 <p>330-106</p>	A19-005***	10¢ Coin Mechanism Assembly	\$ 63.95
	A19-006***	25¢ Coin Mechanism Assembly	\$ 63.95
 <p>330-107</p>	A19-007***	50¢ Coin Mechanism Assembly	\$ 63.95
	A19-013***	\$1 Coin Mechanism Assembly	\$ 55.60
 <p>A19-003</p>	P18-051	Screw	\$ 1.50
	A18-037****	Coin Box Cover & Lock Assembly	\$ 20.90
 <p>P18-051</p>	P10-519	Lock for Coin Box	\$ 6.60
	P10-548	Key for Coin Box	\$ 8.65
 <p>A18-037</p>	S01-374	Napkin Weight Assembly	\$ 14.65
	P20-034	Free Label	\$ 0.90
 <p>P10-519</p>	P20-036	10¢ Label	\$ 0.90
	P20-037	25¢ Label	\$ 1.05
 <p>S01-374</p>	P20-078	50¢ Label	\$ 0.90
	P20-117	\$1 Label	\$ 0.90
 <p>P18-055</p>	P18-055	Screw	\$ 1.80
	P10-558*****	Lock for Door	P15-399
 <p>P10-558</p>	P10-526*****	Key for Door	P15-398
	P20-039A	Maintenance and Loading Instructions	N/C

Includes items P10-517 thru A18-037.

** Recommend also purchasing item P18-028.

*** Includes items P18-051 & label.

**** Includes items P10-519 & P10-548.

*****Refer to Lock & Cam Part No. Reference for Kit No.

Effective Date June 1, 2010

Toilet Tissue Dispensers/Components

Models 5402, 5412 & 5422

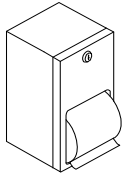

Part No.	Description	Kit Part Number	List Price
P10-571	Plastic Spindle (Kit includes Service Kit & spindle)	P15-407	\$ 4.20
P10-558*	Lock and Cam	P15-399	\$ 6.70

*Refer to Lock & Cam Part No. Reference for Kit No.

Back Clamp for Toilet Tissue Holders

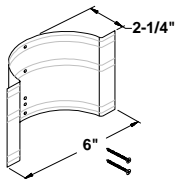

Part No.	Description	List Price
P15-024	510, 5101, 5102, 5103, 5104, 5123*, 5124*, 5125*	\$ 6.10

* Double unit (requires two per unit)

Toilet Tissue Dispenser Spindles

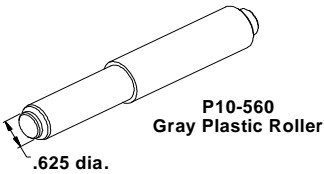
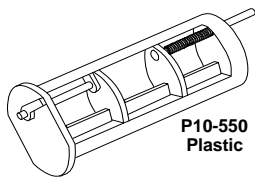

Part No.	Used On Models	Kit Part Number	List Price
P10-550US	5071, 5241* (prior to 1990), 524, 5071-50, 5241-50*		\$ 17.00
P10-550	5071, 5241* (after 1990), 524, 5071-50, 5241-50*		\$ 5.30
P10-560	508, 5084, 5084US, 510, 5102, 5104, 5124*, 523*, 5234*, 5234US*, 5262, 5263*, 5264, 5265*, 5266, 5267*		\$ 2.20
S01-459	Theft-Resistant Spindle - will fit following models: 508, 508-32, 5084, 5085, 5086, 510, 5101, 5102, 5103, 5104, 5124*, 5125*, 5126*, 523*, 5234*, 5235*, 5236*, 5262, 5263*, 5264, 5265*, 5266, 5267*		\$ 8.90
P10-571	5402*, 5412*, 5422*, 590, 5901, 5902, 591, 5911, 5912, 592, 5921, 5922, 594, 5942, 595	P15-407	\$ 4.20
P10-613	5084, 5234*, 5085, 5235*, 5106, 5126*		\$ 6.70
P10-551	540*, 541*, 542*		\$ 8.05

* These models require two spindles per unit.

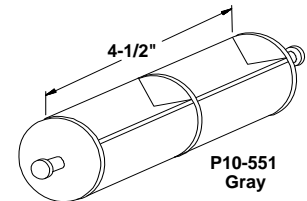
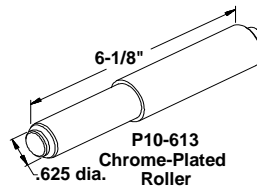
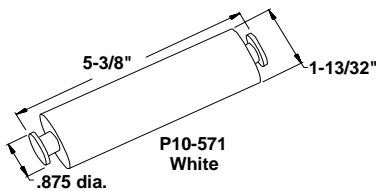

Effective Date June 1, 2010

Soap Dispensers

Models 6542 & 6562 (Components Manufactured 1993 and After)

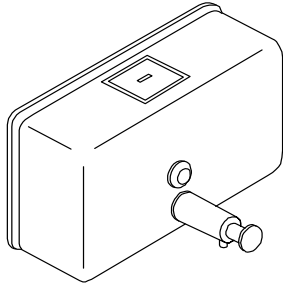

Part No.	Description	Kit Part Number	List Price
P19-212	Liquid Soap Valve (Complete)	P15-408	\$ 25.75
P19-006	Sight Glass (Kit includes Service Kit, (5) per pack)	P15-405	\$ 9.20
P19-001	O-Ring (Prior to Dec '89)		\$ 0.35
P19-165	O-Ring (After Dec '89)		\$ 1.05
P19-153	Horizontal Soap Tank (6542)		\$ 53.30
P19-154	Vertical Soap Tank (6562)		\$ 53.30
P19-140	Mounting Kit (incl. Back Plate, Screws & Key)	P19-140	\$ 5.00
P19-213	Repair Kit for Valves P19-212 (incl. Spring, Housing, O-Ring, Duckbill Check & Rubber Washer)	P19-213	\$ 17.25

NOTE: Repair Kits are not available for older valves P19-134 & P19-159. Order new valve P19-212.

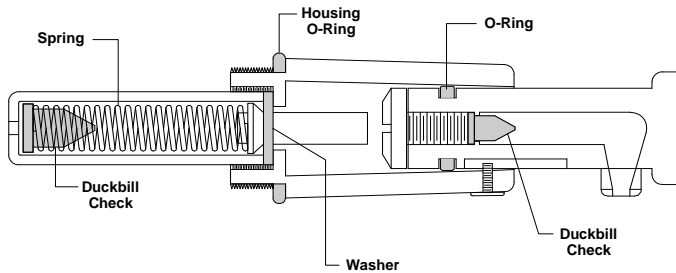

Soap Drawer Assemblies

With Liquid Soap Valve

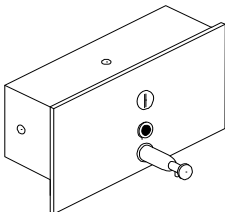

Part No.	Used On Models	List Price
S01-476	120, 130, 131, 133, 186, 194, 1945, 641	\$ 152.00
A14-020	120-14, 130-14, 131-14, 133-14, 186-14, 194-14, 642	\$ 208.80
S01-478	643	\$ 94.50
S01-479	6437	\$ 130.80
S01-482	644	\$ 149.60
M44-047	Brass Nut 3/4"-28 Hex.	\$ 4.40

Soap Valve For Soap Drawer Assemblies is P19-212 (see above).
 Repair Kit For P19-212 is P19-213 (see above).

Plastic Removable Soap Trays

Used On Models 9352, 9353, 9362, 9363

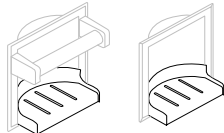

Part No.	Used on Models	List Price
P15-079	Plastic Soap Tray for 9352, 9353, 9362, 9363	\$ 2.70

Effective Date June 1, 2010

Soap Dispensers

Models 6322, 6324 & 6326 (Components Manufactured 1993 and After), 6334

Item	Part No.	Qty	Description	Kit Part Number	List Price
1	P19-151	1	Metal Soap Cont. 16 oz.		\$ 24.30
	P10-287	1	Plastic Soap Cont. 16 oz.		\$ 4.05
	P19-227*	1	Plastic Soap Cont. 16 oz.		\$ 2.50
	P19-119	1	Plastic Soap Cont. 32 oz.	P15-406	\$ 9.15
2	P19-117	1	Adapter		\$ 1.40
3	P19-121	1	Wing Nut		\$ 0.70
4	P19-116	1	Shank		\$ 2.55
	P19-169	1	Shank - Brass		\$ 11.88
5	P19-110	1	Escutcheon		\$ 16.10
	P19-053	1	1" Spacer		\$ 5.20
Spout					
	P19-206	1	2.5"		\$ 85.20
	P19-207	1	4"		\$ 57.40
	P19-208	1	6"		\$ 59.95
Repair Kit P19-187 includes:				P19-187	\$ 14.25
6		1	Washer, Steel		
7		1	Cable Tie		
8		1	Wrench		
9		1	Washer, Neoprene		
10		1	Supply Tube		
11		1	Cylinder		
12		1	Screw		
13		1	Plunger Spacer		
14		1	Compression Spring		
15		1	O-Ring		
16		2	Duckbill Check		
17		1	Washer		

* Model 6334 Only

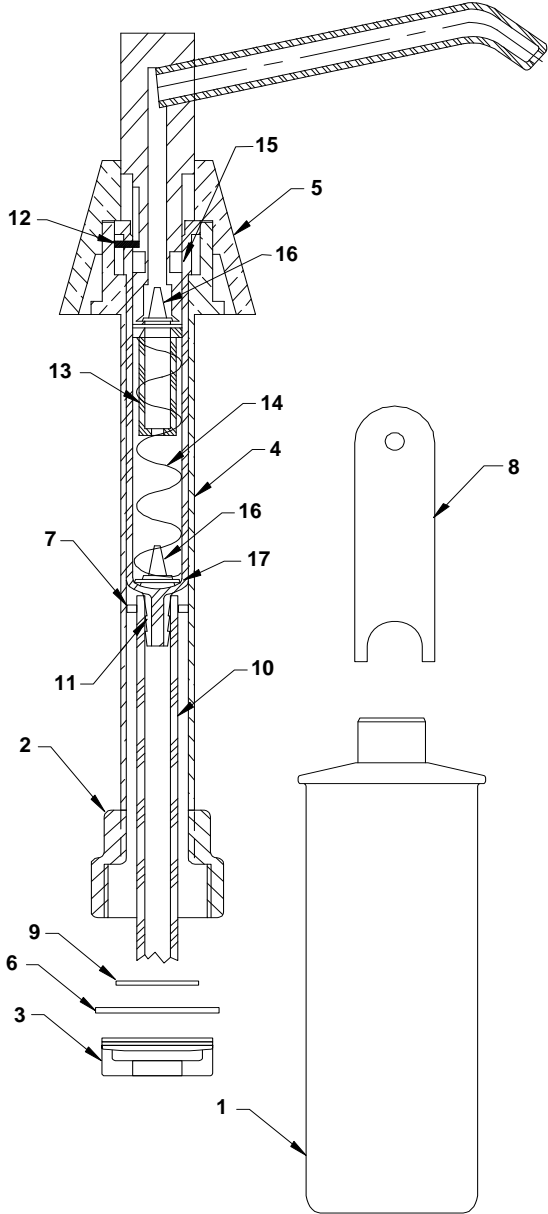

Effective Date June 1, 2010

Automatic Soap Dispenser

Model 6315

Part No.	Qty	Description	List Price
P19-232A	1	1 Case (4 Bottles) 54oz Lotion Soap with Moisturizer	\$108.00
P19-232B	1	1 Case (4 Bottles) 27oz Lotion Soap with Moisturizer	\$64.00
P19-231F	1	AC Adapter for Single Soap Dispenser	\$75.00
P19-231G	1	AC Adapter for up to 4 Dispensers (requires 1 P19-231H per dispenser)	\$165.00
P19-231H	1	Wire assembly (need 1 assembly for every dispenser. Max 4 per P19-231G)	\$25.00
P19-231A	1	Spout Assembly	\$65.00
P19-231B	1	C-Clip	\$1.50
P19-231C	1	Motor Assembly	\$75.00
P19-231D	1	Battery Box	\$35.00
P19-231E	1	Clip - Bottle	\$1.50

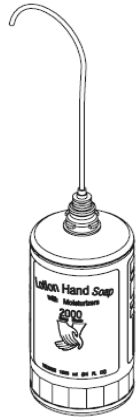

P19-232A
54 oz., 2000 shot

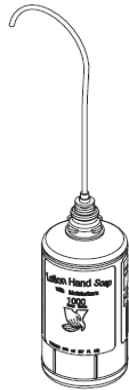

P19-232B
27 oz., 1000 shot

P19-231F
(AC Adaptor for single soap dispenser)

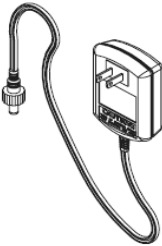

P19-231H
(Wire assembly)

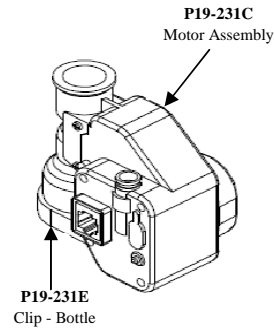

P19-231E
Clip - Bottle

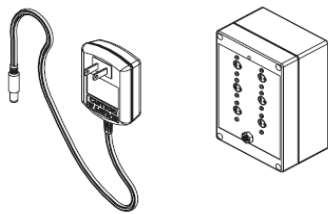

P19-231G
(AC adaptor for up to 4 soap dispensers)



P19-231A
Spout Assembly



P19-231B
C-Clip



P19-231D
Battery Box

Effective Date June 1, 2010

Grab Bar Couplings

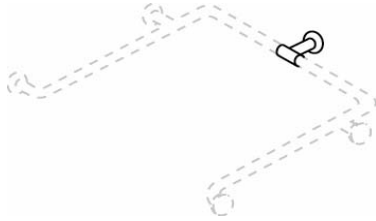

Part No.	Used On Models	List Price
U17-660	812	\$ 85.60
U15-660	832	\$ 106.90

Retaining Bracket for Shower Seats

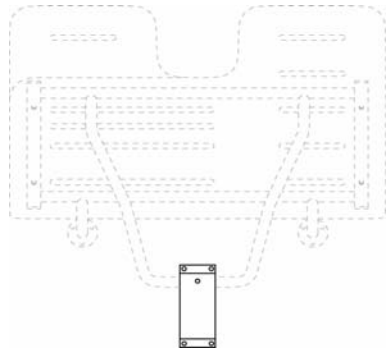

Part No.	Description	List Price
S01-255	Retaining Bracket for All Shower Seats Except 954, 9541, 9569	\$ 46.70
A18-052	Wall-Mtd. Support Assembly for 9569	\$ 40.30

Effective Date June 1, 2010

Post Sets for Towel Bars

Part No.	Description	List Price
9054-P00000	9054	\$ 20.70
9055-P00000	9055	\$ 24.30
9065-P00000	9065	\$ 20.70
9066-P00000	9066	\$ 24.30
926-P00000	926	\$ 16.00
927-P00000	927	\$ 16.00

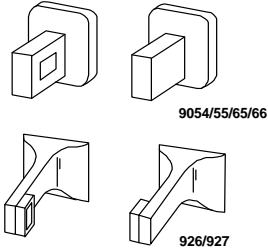

Towel Dispenser Accessories

Part No.	Description	List Price
M08-001	Towel Pan for 2017, 225, 2252, 247, 2478 Towel Disp.; 2017, 2018, 2037, 237, 2038, 238 Towel/Waste Unit; 130, 155 Multi-Unit	\$ 32.80
M08-005	Towel Pan for A01, 270 Multi Purpose Unit	\$ 88.00
P10-689	Towel Dispenser Knob (white) and screw pack (5 per) for P10-561	\$ 9.10
P10-561	Towel Dispenser Mechanism for 227 & 2277 Towel/Waste Unit; 2481, 2483, 2484 Roll Towel Disp.; Ps200, S08 Cabinet Assy.	\$ 135.00
P15-394	Spring for P10-561 Towel Dispenser	\$ 0.60
A17-003	Service kit for 236 Towel/Waste Unit. 2 Service part Towel dispenser center pulls, 4 Lip Trims, 1 set of instructions.	\$ 28.00
P10-687	Cone for 236 Towel/Waste Unit.	\$ 5.33
P10-697	Hands-Free Roll Towel Dispenser, Less Cover for 233 Towel/ Waste Unit	\$ 122.25

Miscellaneous Parts

Part No.	Description	List Price
P18-078	Door latch for 2018, 2028, 2038, 2298 Towel/Waste Receptacle; 2443, 2448, 2478 Towel Dispenser; 3158, 3258 Waste Receptacle; 4738 Napkin Disp.; 5848 Seat Cover Disp.	\$ 1.45
P10-695	Shield for 5900 Series Combination Units	\$ 16.10
P18-116	Nylon Snap Rivet for P10-695	\$ 0.20

Effective Date June 1, 2010

Shower Curtain Flanges

Part No.	Used On Models	Description	List Price
701-600	953	1" Exposed Flange	\$ 2.90
701-600A	9531	1-1/4" Exposed Flange	\$ 2.90
9532-F00000	9532	1" Exposed Flange	\$ 12.45
P10-482	9538	1" Concealed Flange	\$ 2.30
U10-666	9538	1" Cover Flange	\$ 2.10
P10-482A	9539	1-1/4" Concealed Flange	\$ 2.65
U12-666	9539	1-1/4" Cover Flange	\$ 2.45

Baby Changing Stations

Part No.	Used On Models	Description	List Price
9611-PS902566	961, 9611, 9612	Replacement Strap	\$ 46.40
MM0-PS902592	961, 9611, 9612	Case of 500 White Liners	\$ 140.00

Miscellaneous

Part No.	Used On Models	Description	List Price
P10-526*	All Models W/Locks	Key	P15-398
P18-073	All Models W/Torx Head W/Pin Security Screws	Torx Tool Kit	\$ 53.40
330-074	All Mirrors W/H-Hangers	Mirror Release Tool	\$ 29.70
P10-636	All Models W/Locks	Turn Knob Key	\$ 2.65

*Refer to Lock & Cam Part No. Reference for Kit No.

Effective Date June 1, 2010

Mirror Glass

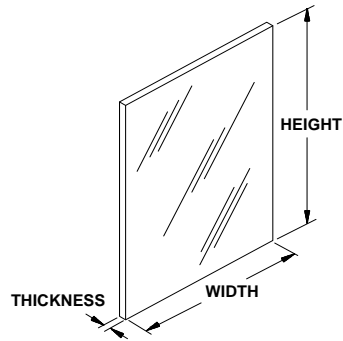

Part No.	Used On Models	Size (Inches)			List Price
		Width	Height	Depth	
P13-002	130, 133, 155	14-13/16	17-13/16	1/4	\$ 21.40
P13-008	175	16-13/16	30-3/8	1/4	\$ 42.80

Replacement mirror glass sizes for 780, 7805, 781, 7815, 740, 7405, 782 angle frame & channel frame mirrors.

Mirror glass size - 1" less than overall size mirror; (example: 780-16 x 24 mirror glass would be 15 x 23)

Mirror Accessory Large Mirrors -100" Plus

A18-054	Support Bracket Kit	2-1/2	3-3/4	1	\$ 52.40
---------	---------------------	-------	-------	---	----------

Kit includes: two brackets and instruction sheets.

Replacement Shelves

For Medicine Cabinets

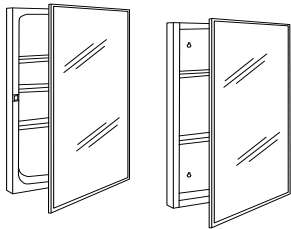
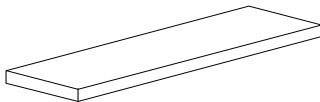

Part No.	Used On Models	Description	List Price
P15-377	966	Stainless	\$ 12.20
P15-378	966-11	Stainless	\$ 12.45
P15-379	9662	Stainless	\$ 13.25
P15-380	9663	Stainless	\$ 12.20
P15-385	9664	Stainless	\$ 13.50

Lock & Cam Part Number Reference

Model No.	Lock & Cam Part No.	List Price	Model No.	Lock & Cam Part No.	List Price
130-000000	P10-596 (door)	\$ 9.70	334-000000	P10-568	Service Kit
130-000000	P10-558 (soap disp)	Service Kit	344-000000	P10-568	Service Kit
1471-000000	P10-558	Service Kit	346-000000	P10-568	Service Kit
1471-1100000	P10-558	Service Kit	401 Series	P10-558 (door)	Service Kit
155-000000	P10-596	\$ 9.70	401 Series	P10-519 (coin box)	\$ 6.60
170-000000	P10-066	\$ 19.55	4017-000000	P10-558 (door)	Service Kit
194-000000	P10-565 (towel disp)	Service Kit	4017-000000	P10-519 (coin box)	\$ 6.60
194-000000	P10-558 (soap disp)	Service Kit	4018 Series	P10-558 (door)	Service Kit
198-000000	P10-565	Service Kit	4018 Series	P10-519 (coin box)	\$ 6.60
1981-000000	P10-558	Service Kit	402-000000	P10-558 (door)	Service Kit
1985-000000	P10-565	Service Kit	402-000000	P10-519 (coin box)	\$ 6.60
2017-000000	P10-565	Service Kit	403 Series	P10-558 (door)	Service Kit
2027-000000	P10-565	Service Kit	403 Series	P10-519 (coin box)	\$ 6.60
2037-000000	P10-565	Service Kit	404 Series	P10-558 (door)	Service Kit
225-000000	P10-558	Service Kit	404 Series	P10-519 (coin box)	\$ 6.60
2251-000000	P10-558	Service Kit	407 Series	P10-558 (door)	Service Kit
2252-000000	P10-558	Service Kit	407 Series	P10-519 (coin box)	\$ 6.60
227-000000	P10-558 (door)	Service Kit	426 Series	P10-558 (door)	Service Kit
227-000000	P10-568 (W/R)	Service Kit	426 Series	P10-519 (coin box)	\$ 6.60
2271-000000	P10-558 (door)	Service Kit	428 Series	P10-558 (door)	Service Kit
2271-000000	P10-568 (W/R)	Service Kit	428 Series	P10-519 (coin box)	\$ 6.60
2277-000000	P10-565	Service Kit	4721-150000	P10-565	Service Kit
229-000000	P10-558	Service Kit	4722-101500	P10-565	Service Kit
2291-000000	P10-558	Service Kit	4722-150000	P10-565	Service Kit
2297-000000	P10-565	Service Kit	4731-150000	P10-565	Service Kit
233-000000	P10-558 (door)	Service Kit	4737-000000	P10-558	Service Kit
233-000000	P10-568 (W/R)	Service Kit	4781-150000	P10-567	Service Kit
234-000000	P10-568	Service Kit	4791-150000	P10-567	Service Kit
235-000000	P10-558, P10-568	Service Kit	5402-000000	P10-558	Service Kit
236-000000	P10-558 (door)	Service Kit	5412-000000	P10-558	Service Kit
236-000000	P10-568 (W/R)	Service Kit	5422-000000	P10-558	Service Kit
237-000000	P10-558 (door)	Service Kit	5424-000000	P10-558	Service Kit
237-000000	P10-568 (W/R)	Service Kit	5425-000000	P10-565	Service Kit
238-000000	P10-558	Service Kit	583-000000	P10-567	Service Kit
244-000000	P10-558	Service Kit	584-000000	P10-558	Service Kit
2441-000000	P10-558	Service Kit	5847-000000	P10-558	Service Kit
2442-000000	P10-565	Service Kit	591-000000	P10-558	Service Kit
2447-000000	P10-565	Service Kit	5911-000000	P10-558	Service Kit
247-000000	P10-558	Service Kit	5912-000000	P10-558	Service Kit
2481-000000	P10-558	Service Kit	592-000000	P10-558	Service Kit
250-150000	P10-565	Service Kit	5921-000000	P10-558	Service Kit
250-330000	P10-565	Service Kit	5922-000000	P10-558	Service Kit
251-150000	P10-621	Service Kit	5932-000000	P10-558	Service Kit
252-000000	P10-565	Service Kit	594-000000	P10-558	Service Kit
270-000000	P10-558	Service Kit	5942-000000	P10-558	Service Kit
315-350000	P10-558	Service Kit	643-000000	P10-558	Service Kit
3157-000000	P10-565	Service Kit	6437-000000	P10-558	Service Kit
3251-000000	P10-558	Service Kit	644-000000	P10-558	Service Kit
3257-000000	P10-565	Service Kit	9495-000000	P10-567	Service Kit

**P10-526 key unlocks
all locks except
P10-519**

Service Kits

Description	Kit Number	List Price
Key P10-526 (5 keys per kit)	P15-398	\$ 8.70
P10-558 lock, clip, & key kit	P15-399	\$ 6.70
P10-565 lock, clip, & key kit	P15-400	\$ 6.70
P10-567 lock, clip, & key kit	P15-401	\$ 6.70
P10-568 lock, clip, & key kit	P15-402	\$ 6.70
P10-621 lock, clip, & key kit	P15-404	\$ 6.70

Effective Date June 1, 2010

Kit Reference Guide

Part No.	Description	Quantity	Kit No.	List Price	Ref. Page
P11-030	Waxed Paper Liner	500	P11-022	\$ 225.00	3
P10-526	Key	5	P15-398	\$ 8.70	14
P10-558	Lock, Clip, & Key	1	P15-399	\$ 6.70	14
P10-565	Lock, Clip, & Key	1	P15-400	\$ 6.70	14
P10-567	Lock, Clip, & Key	1	P15-401	\$ 6.70	14
P10-568	Lock, Clip, & Key	1	P15-402	\$ 6.70	14
P10-596	Lock, Clip, & Key	1	P15-403	\$ 20.70	14
P10-621	Lock, Clip, & Key	1	P15-404	\$ 6.70	14
P19-006	Sight Glass	5	P15-405	\$ 9.20	7
P19-119	32 oz. Plastic Soap Bottle	1	P15-406	\$ 9.15	8
P10-571	Toilet Tissue Spindle	1	P15-407	\$ 4.20	6
P19-212	Soap Valve	1	P15-408	\$ 25.75	7
P19-140	Mounting Kit (Backplate, Screws, Key)	1	P19-140	\$ 5.00	7
P19-213	Repair Kit - Soap Valves	1	P19-213	\$ 17.25	7
P19-187	Repair Kit - Saop Dispenser	1	P19-187	\$ 14.25	8