



TEL: 800.BRADLEY
FAX: 262.251.5817
bradleycorp.com

Washroom Accessories Service Parts List Price Book 1110WSP

Effective Date October 1, 2011

Table of Contents











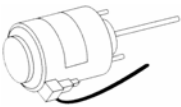
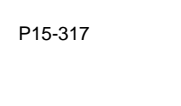
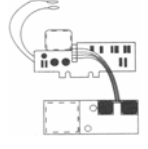





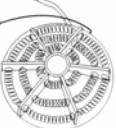

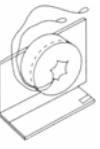





Hair-Hand Dryers (Models 2870 thru 2874, 2889, 2896, & 2897)	2
Hand Dryers (Models 2875-28 & 2885-28, 2877-28 & 2887-28)	3
Aerix Hand Dryer (Series 2902-28, 2903-28, 2904-28, & 2905-2873)	4
Waste Receptacles, Waste Receptacle Liners ***	5
Napkin-Tampon Vendors (Models 401, 4017, 4018, 403, 407, 426 & 428)	6
Napkin Vendors (Models 402 & 427 manufactured after August 1993)	7
Toilet Tissue Dispensers (Models 5402, 5412 & 5422) ***	8
Back Clamp and Spindles for Toilet Tissue Dispensers ***	8
Soap Dispensers (Models 6542 & 6562; 1993 and later) ***	9
Soap Drawers and Soap Trays	9
Soap Dispensers (Models 6322, 6324 & 6326; 1993 and later) 6334***	10
Automatic Soap Dispenser (Model 6315)	11
Grab Bar Couplings, Retaining Bracket for Shower Seats	12
Post Sets for Towel Bars, Towel Dispenser Accessories	13
Miscellaneous Parts	13
Collars: Recessed to Semi-Recessed	14
Collars: Recessed to Surface-Mounted	15
Shower Curtain Flanges, Diaper Changing Stations, Miscellaneous	16
Mirror Glass, Medicine Cabinet Replacement Shelves	17
Lock & Cam Part Number Reference ***	18
Kit Reference Guide ***	19

*** USE KIT NUMBERS TO ORDER PARTS

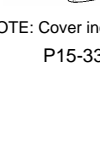
Effective Date October 1, 2011

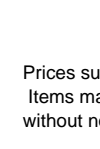
Hair/Hand Dryers - Cast Iron

Models 2870 Thru 2874, 2889, 2896, & 2897

Part No.	Description	Quantity	List Price
	P15-317 Motor - 115 Volt	1	\$ 334.30
	P15-318 Motor - 208/230 Volt	1	\$ 346.40
	P15-319+ Heating Element - 115 Volt - 20AMP	1	\$ 85.00
	P15-320+ Heating Element - 230 Volt - 10.5AMP	1	\$ 92.80
	P15-346+ Heating Element - 208 Volt - 11 AMP	1	\$ 85.00
	P15-298 Screw - Surface Cover	1	\$ 3.00
	P15-316 Screw - Recessed Cover	1	\$ 5.20
	P15-304 Allen Wrench	1	\$ 10.30
	P15-301*** Timer - 115 Volt - 30 SEC - 60HZ	1	\$ 187.00
	P15-302*** Timer - 208/230 Volt - 30 SEC - 60HZ	1	\$ 187.00
	P15-321*** Timer - 115 Volt - 80 SEC - 60HZ	1	\$ 170.00
	P15-322*** Timer - 208/230 Volt - 80 SEC - 60HZ	1	\$ 170.00
	P15-335*** Timer - 230 Volt - 30 SEC - 50HZ	1	\$ 170.00
	P15-336*** Timer - 230 Volt - 80 SEC - 50HZ	1	\$ 170.00
	P15-300 Fuse Block Assembly	1	\$ 12.90
	P15-299 Fuse - 2AMP Glass	1	\$ 3.00
	P15-323** Push Button Assembly	1	\$ 63.50
	P15-324** Push Button Spring Kit	1	\$ 7.70
	P15-325 Brushes - GE w/Black Cartridge	1	\$ 28.90
	P15-326 Brushes - GE w/White Cartridge	1	\$ 37.00
Cover - Model 2870 (Surface-Mounted)			
	P15-342 White	1	\$ 515.00
Cover - Model 2871			
	P15-331A White	1	\$ 562.50
Cover - Model 2872			
	P15-359A White	1	\$ 562.50
Cover - Model 2873			
	P15-330A White	1	\$ 515.00
Cover - Model 2874			
	P15-358A White	1	\$ 515.00
	P15-347 Switch Only (Open Blade Type)	1	\$ 67.00
	P15-348 Micro Switch Only	1	\$ 67.00
	P15-351 Push Button Adaptor & Bearing Kit	1	\$ 36.10
	P15-353 Inlet Grill, Brackets & Rivets (Surface Vandal Resistant)	1	\$ 52.90
	P15-354 Inlet Grill, Brackets & Rivets (Recessed Standard)	1	\$ 54.10

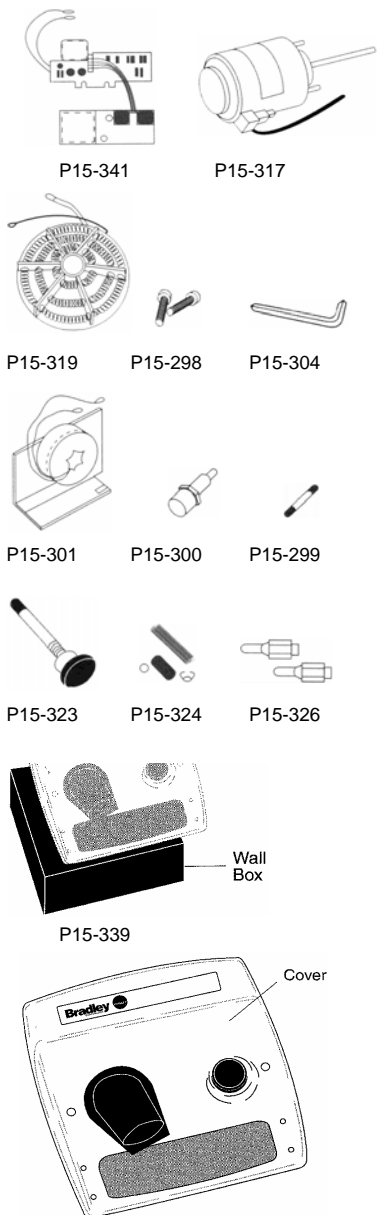

NOTE: Cover includes nozzle and push button.
P15-331A

* Models 2870

** Models 2871 thru 2874

+ Models need Serial Number when ordering replacement parts.

+Please have the serial number located on the outside of the cover at hand when ordering service parts to ensure the correct parts are being ordered.

Effective Date October 1, 2011

Hand Dryers

Models 2875 & 2885, 2877 & 2887

	Part No.	Description	Quantity	List Price
	P15-315A	Insert Panel - Snow White	1	\$ 69.40
	P15-315D	Insert Panel - Country Beige	1	\$ 69.40
	P15-315M	Insert Panel - Chrome	1	\$ 69.40
	P15-328+	Cover Assembly - Satin Chrome Finish	1	\$ 513.10
	P15-329+	Cover Assembly - White Finish	1	\$ 376.00
	P15-309	Blower Wheel - 4-3/4" Dia.	1	\$ 30.90
	P15-305+	Motor Kit - 120 Volt - 60HZ	1	\$ 212.60
	P15-307+	Motor Kit - 208/240 Volt - 60HZ	1	\$ 212.60
	P15-306+	Capacitor 120 Volt	1	\$ 56.70
	P15-308+	Capacitor 208/240 Volt	1	\$ 56.70
	P15-310+	Heating Element - 120 Volt	1	\$ 73.70
	P15-311+	Heating Element - 208 Volt	1	\$ 67.00
	P15-333+	Heating Element - 220 Volt	1	\$ 67.00
	P15-298	Screw - Cover	1	\$ 3.00
	P15-300	Fuse Holder - Glass Fuse	1	\$ 12.90
	P15-299	Fuse - 2AMP	1	\$ 3.00
	P15-301+	Timer - 120 Volt - 30 SEC - 60HZ	1	\$ 187.00
	P15-302+	Timer - 208/240 Volt - 30 SEC - 60HZ	1	\$ 187.00
	P15-321+	Timer - 120 Volt - 80 SEC - 60HZ	1	\$ 170.00
	P15-322+	Timer - 208/240 Volt - 80 SEC - 60HZ	1	\$ 170.00
P15-335+	Timer - 220/240 Volt - 30 SEC - 50HZ	1	\$ 170.00	
P15-336+	Timer - 220/240 Volt - 80 SEC - 50HZ	1	\$ 170.00	
P15-313	Pushbutton Assembly	1	\$ 48.50	
P15-337	Spring & Bumper Kit	1	\$ 7.70	
P15-304	Allen Wrench	1	\$ 10.30	

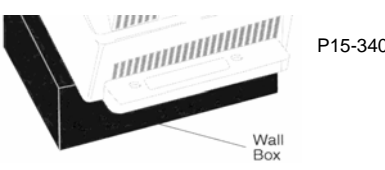
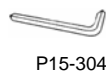
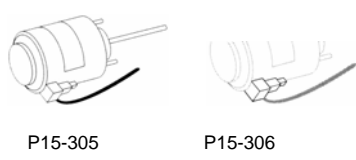
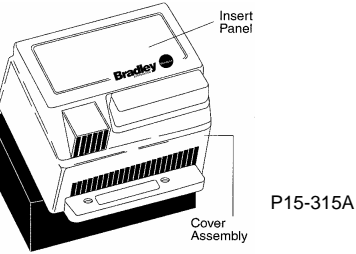

+ Models need Serial Number when ordering replacement parts.
 +Please have the serial number located on the outside of the cover at hand when ordering service parts to ensure the correct parts are being ordered.

Effective Date October 1, 2011

Hand Dryers

Models 2902-28, 2902-2873, and 2902-2874

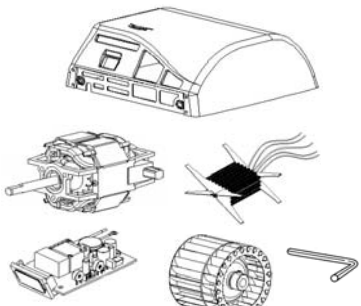
	Part No.	Description	Quantity	List Price
	P15-411	Cast Iron Cover - White	1	\$ 425.00
	P15-412	Steel Cover - White	1	\$ 375.00
	P15-413	Stainless Steel Cover - Satin	1	\$ 400.00
	P15-414	Motor	1	\$ 315.00
	P15-415	Heating Element	1	\$ 90.00
	P15-416	Sensor Set	1	\$ 190.00
	P15-417	Motor Brushes	1	\$ 35.00
	P15-418	Turbine	1	\$ 50.00
	P15-419	Wrench	1	\$ 10.00
	P15-444	Rubber Cushions / Silent Blocks	1	\$ 4.00
	P15-445	Sensor Window	1	\$ 15.00
	P15-446	Motor Spring	1	\$ 6.00

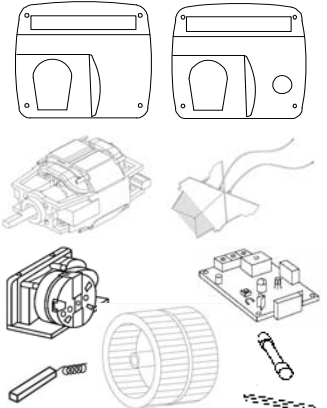
	Part No.	Description	Quantity	List Price
	P15-420	Cast Iron Cover, Sensored - White	1	\$ 500.00
	P15-421	Cast Iron Cover, Push Button - White	1	\$ 500.00
	P15-422	Motor - UL	1	\$ 300.00
	P15-423	Motor - CE	1	\$ 325.00
	P15-424	Heating Element - UL	1	\$ 75.00
	P15-425	Heating Element - CE	1	\$ 80.00
	P15-426	Timer - UL	1	\$ 165.00
	P15-427	Timer - CE	1	\$ 170.00
	P15-428	Sensor Set - UL	1	\$ 175.00
	P15-429	Sensor Set - CE	1	\$ 180.00
	P15-417	Motor Brushes	1	\$ 35.00
	P15-430	Fan Wheel	1	\$ 25.00
	P15-431	Fuse - UL	1	\$ 3.00
	P15-419	Wrench	1	\$ 10.00
	P15-446	Motor Spring	1	\$ 6.00
	P15-447	Sensor Cable (2903 Only)	1	\$ 10.00

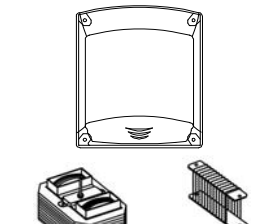
	Part No.	Description	Quantity	List Price
	P15-433	Steel Cover - White	1	\$ 200.00
	P15-434	Motor - UL and Fan Wheel	1	\$ 70.00
	P15-435	Motor - CE and Fan Wheel	1	\$ 75.00
	P15-436	Heating Element - UL	1	\$ 40.00
	P15-437	Heating Element - CE	1	\$ 45.00
	P15-438	Sensor Set - UL	1	\$ 135.00
	P15-439	Sensor Set - CE	1	\$ 140.00
	P15-440	Fan Wheel	1	\$ 20.00
	P15-441	Wrench	1	\$ 10.00

Need Serial Number when ordering replacement parts.

Please have the serial number located on the outside of the cover at hand when ordering service parts to ensure the correct parts are being ordered.

Effective Date October 1, 2011

Waste Receptacles

Molded Plastic & Stainless Steel Waste Receptacles

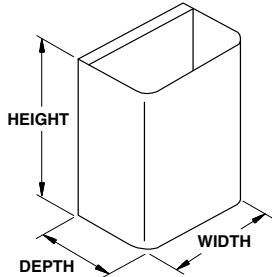

STAINLESS STEEL

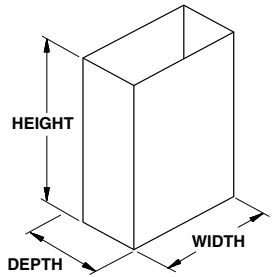

MOLDED PLASTIC

Part No.	* Used On Models	Size (Inches)			Gallons	List Price
		Width	Height	Depth		
P11-028	P 2017, 2018, 2227, 2228, 2252	10-3/4	20	5-1/4	4.9	\$ 58.90
M44-005	P 2027, 2028	10-3/4	20	3-1/2	3.3	\$ 45.80
P11-037	P 2037, 2038	14-1/4	26	7	11.2	\$ 55.10
P11-025	P 225, 2257, 2258, 315, 3157, 3158	10-3/4	38	5-1/4	9.2	\$ 72.10
P11-034	P 2251	10-3/4	38	3	5.3	\$ 32.50
S03-011000000	S 227, 2271, 236-36, 237-36, 334	15	23	12-3/4	18	\$ 219.50
700-505	S 229	11-15/16	6	4	1.25	\$ 71.40
A05-005	S 2291	11-15/16	9-1/16	3-15/16	2	\$ 53.50
P11-035	P 2297, 2298	11-15/16	9-1/16	3-9/16	1.7	\$ 28.00
S03-005000000	S 234-35, 237, 344, 346	15	23	8-3/4	12	\$ 212.20
S03-005350000	S 344	15	23	8-3/4	12	\$ 298.70
S03-005650000	S 234-65, 344	15	23	8-3/4	12	\$ 204.00
A05-012000000	S 234 (after 1/02)	15	23	8-3/4	12	\$ 164.70
P11-027	P 235, 2357, 2358	14	23	3-1/2	4.9	\$ 50.30
P11-036	P 238, 238-10, 238-1027, 238-11, 238-27, 238-35	14	23	5-7/8	8.2	\$ 33.00
P11-039	P 403, 428	10-7/8	7	5-3/10	1.5	\$ 66.00
M44-006	P 3251, 3257, 3258	10-3/4	17	3-1/2	2.8	\$ 45.80
A05-007	S 4721.4722	10-1/2	9-1/16	3-15/16	1.5	\$ 48.40
S01-415	S 4731	10-11/16	9-1/16	4	1.5	\$ 50.30
P11-032	P 591, 5911,	8	10-3/4	3-5/8	0.9	\$ 25.00
P11-031	P 5912, 594, 5942	8	8	3-5/8	1.0	\$ 38.10
M44-048	P 593, 5931, 5932	14	8	3-1/2	1.7	\$ 62.20
P11-038	P 2277	14-1/4	9-3/4	17-3/8	10.5	\$ 33.00
P15-025	S 377 Swing Top Only	13	7	13	n/a	\$ 252.40
P15-098	S 377- 36 Swing Top Only	15	8	15	n/a	\$ 255.00
P15-195	S 377- 38 Swing Top Only	19	10	19	n/a	\$ 287.40
A05-015	S 3251-990002	34	11-7/8	16	14.5	\$ 450.00

* P = Plastic, S = Stainless Steel

Waste Receptacle Liners

PVC Vinyl Liners and Waxed Paper Liners

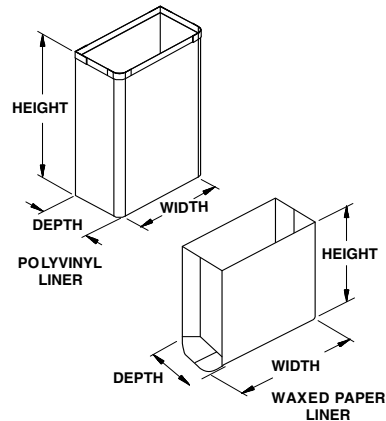

Part No.	Used On Models	Size (Inches)			Kit Part Number	List Price
		Width	Height	Depth		
PVC Vinyl						
P11-001	227, 2271, 234-36, 237-36, 334, 336	14	23	11-3/4		\$ 18.75
P11-004	233, 234, 237, 344, 346	14-3/4	23	7		\$ 18.30
P11-005	355	16	23	12		\$ 18.30
P11-006	356	18	23	9		\$ 19.00
P11-007	357	13-1/2	18	5-1/2		\$ 17.50
P20-134	Instructions					\$ 0.10
Waxed						
P11-030	2258, 359, 403, 428, 4721, 4722, 4727, 4731, 4737, 4738, 4781, 4791, 591, 5911, 5912, 594, 5942	9	11	4	P11-022 (Box of 500)	\$ 225.00

 Prices subject to change without notice.
 Items may be changed or discontinued without notice and without incurring obligation.

Effective Date October 1, 2011

Napkin/Tampon Vendors

Models 401, 4017, 4018, 403, 407, 426 & 428

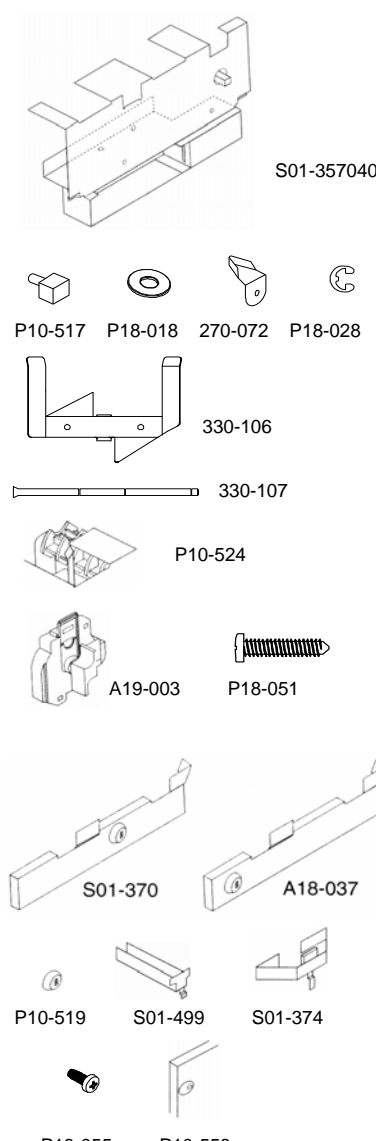
	Part No.	Description	List Price
 <p>S01-357040</p> <p>P10-517 P18-018 270-072 P18-028</p> <p>330-106</p> <p>330-107</p> <p>P10-524</p> <p>A19-003 P18-051</p> <p>S01-370 A18-037</p> <p>P10-519 S01-499 S01-374</p> <p>P18-055 P10-558</p>	S01-357040*	Free Coin Mounting Plate Assembly	\$ 214.40
	S01-357042*	10¢ Coin Mounting Plate Assembly	\$ 214.40
	S01-357043*	50¢ Coin Mounting Plate Assembly	\$ 214.40
	S01-357044*	\$1 Coin Mounting Plate Assembly	\$ 214.40
	S01-357045*	25¢ Coin Mounting Plate Assembly	\$ 214.40
	P10-517	Slave Shaft (Recommend also purchasing P18-028)	\$ 3.80
	P18-018	Flat Washer	\$ 0.50
	270-072	Cam	\$ 4.40
	P18-028	Retaining Ring	\$ 0.70
	330-106	Napkin Paddle	\$ 6.90
	330-107	Coined Shaft (Recommend also purchasing P18-028)	\$ 7.10
	P10-524	Tampon Rotor	\$ 9.70
	A19-003***	Free Coin Mechanism Assembly	\$ 63.95
	A19-005***	10¢ Coin Mechanism Assembly	\$ 63.95
	A19-006***	25¢ Coin Mechanism Assembly	\$ 63.95
	A19-007***	50¢ Coin Mechanism Assembly	\$ 63.95
	A19-013***	\$1 Coin Mechanism Assembly	\$ 55.60
	M44-074	Coin Mechanism Handle	\$ 25.00
	P18-051	Screw	\$ 1.50
	S01-370**	Coin Box Cover & Lock Assembly (for units manufactured before 1993)	\$ 30.15
	A18-037**	Coin Box Cover & Lock Assembly (for units manufactured after 1993)	\$ 20.90
	A18-048	Tampon Cam Assembly	\$ 33.10
	P10-519	Lock for Coin Box	\$ 6.60
	P10-548	Key for Coin Box	\$ 8.65
	S01-499	Tampon Weight Assembly	\$ 13.15
	S01-374	Napkin Weight Assembly	\$ 14.65
	P20-034	Free Label	\$ 0.90
	P20-036	10¢ Label	\$ 0.90
P20-037	25¢ Label	\$ 1.05	
P20-078	50¢ Label	\$ 0.90	
P20-117	\$1 Label	\$ 0.90	
P18-055	Screw	\$ 1.80	
P10-558****	Lock for Door	P15-399	
P10-526****	Key for Door	P15-398	
P20-039	Maintenance and Loading Instructions	\$ 0.70	

Includes items P10-517 thru A18-037.

** Includes items P10-519 & P10-548.







*** Includes items P18-051 & label.

**** Refer to Lock & Cam Part No. Reference for Kit No.

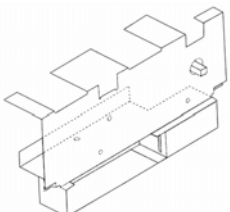
Effective Date October 1, 2011

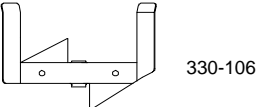
Napkin Vendors

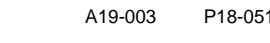
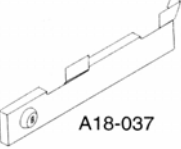
Models 402 & 427 (Manufactured after August 1993)

	Part No.	Description	List Price
 <p>S01-361040</p>	S01-361040*	Free Coin Mounting Plate Assembly	\$ 146.30
	S01-361042*	10¢ Coin Mounting Plate Assembly	\$ 146.30
	S01-361045*	25¢ Coin Mounting Plate Assembly	\$ 146.30
	S01-361043*	50¢ Coin Mounting Plate Assembly	\$ 146.30
	S01-361044*	\$1 Coin Mounting Plate Assembly	\$ 146.30
	P10-517**	Slave Shaft	\$ 3.80
	P18-018	Flat Washer	\$ 0.50
	270-072	Cam	\$ 4.40
	P18-028	Retaining Ring	\$ 0.70
	330-106	Napkin Paddle	\$ 6.90
 <p>P10-517 P18-018 270-072 P18-028</p>	330-107**	Coined Shaft	\$ 7.10
	A19-003***	Free Coin Mechanism Assembly	\$ 63.95
 <p>330-106</p>	A19-005***	10¢ Coin Mechanism Assembly	\$ 63.95
	A19-006***	25¢ Coin Mechanism Assembly	\$ 63.95
	A19-007***	50¢ Coin Mechanism Assembly	\$ 63.95
	A19-013***	\$1 Coin Mechanism Assembly	\$ 55.60
 <p>P18-051</p>	P18-051	Screw	\$ 1.50
	A18-037****	Coin Box Cover & Lock Assembly	\$ 20.90
 <p>A19-003 P18-051</p>	P10-519	Lock for Coin Box	\$ 6.60
	P10-548	Key for Coin Box	\$ 8.65
	S01-374	Napkin Weight Assembly	\$ 14.65
	P20-034	Free Label	\$ 0.90
	P20-036	10¢ Label	\$ 0.90
 <p>A18-037</p>	P20-037	25¢ Label	\$ 1.05
	P20-078	50¢ Label	\$ 0.90
	P20-117	\$1 Label	\$ 0.90
	P18-055	Screw	\$ 1.80
 <p>P10-519 S01-374</p>	P10-558*****	Lock for Door	P15-399
	P10-526*****	Key for Door	P15-398
	P20-039A	Maintenance and Loading Instructions	N/C

Includes items P10-517 thru A18-037.
 ** Recommend also purchasing item P18-028.
 *** Includes items P18-051 & label.
 **** Includes items P10-519 & P10-548.
 *****Refer to Lock & Cam Part No. Reference for Kit No.

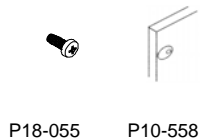

Effective Date October 1, 2011

Toilet Tissue Dispensers/Components

Models 5402, 5412 & 5422

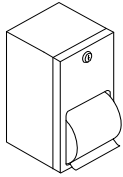

Part No.	Description	Kit Part Number	List Price
P10-571	Plastic Spindle (Kit includes Service Kit & spindle)	P15-407	\$ 4.20
P10-558*	Lock and Cam	P15-399	\$ 6.70
M09-003	Door Panel		\$ 11.10
P10-407	Rivet for Door Panel		\$ 0.10

*Refer to Lock & Cam Part No. Reference for Kit No.

Back Clamp for Toilet Tissue Holders

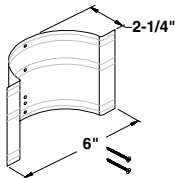

Part No.	Description	List Price
P15-024	510, 5101, 5102, 5103, 5104, 5123*, 5124*, 5125*	\$ 6.10

* Double unit (requires two per unit)

Toilet Tissue Dispenser Spindles

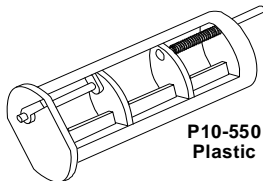
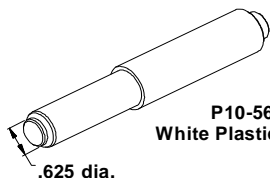
**P10-550
Plastic**

**P10-560
White Plastic Roller**

Part No.	Used On Models	Kit Part Number	List Price
P10-550US	5071, 5241* (prior to 1990), 524, 5071-50, 5241-50*		\$ 17.00
P10-550	5071, 5241* (after 1990), 524, 5071-50, 5241-50*		\$ 5.30
P10-560	508, 5084, 5084US, 510, 5102, 5104, 5124*, 523*, 5234*, 5234US*, 5262, 5263*, 5264, 5265*, 5266, 5267*, 5269*		\$ 2.20
S01-459	Theft-Resistant Spindle - will fit following models: 508, 508-32, 5084, 5085, 5086, 510, 5101, 5102, 5103, 5104, 5105, 5124*, 5125*, 5126*, 523*, 5234*, 5235*, 5236*, 5262, 5263*, 5264, 5265*, 5266, 5267*		\$ 8.90
P10-571	5402*, 5412*, 5422*, 590, 5901, 5902, 591, 5911, 5912, 592, 5921, 5922, 594, 5942, 595	P15-407	\$ 4.20
P10-613	5084, 5234*, 5085, 5235*, 5106, 5126*		\$ 6.70
P10-551	540*, 541*, 542*		\$ 8.05
P10-707	Core Adapter for 5424 Single Jumbo Roll		\$ 1.50
M14-006	Shield for Combis before 2004		\$ 9.80
P10-695	Shield for Combis after 2004		\$ 16.10

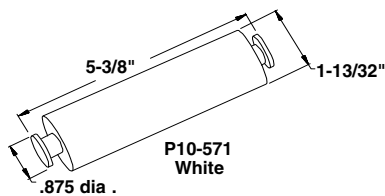
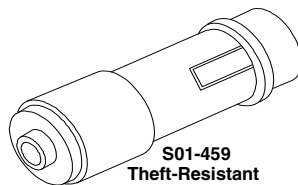
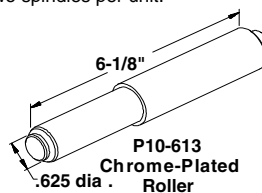
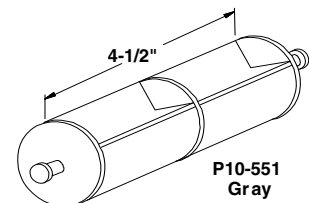
* These models require two spindles per unit.



**P10-571
White**

**S01-459
Theft-Resistant**

**P10-613
Chrome-Plated
Roller**

**P10-551
Gray**

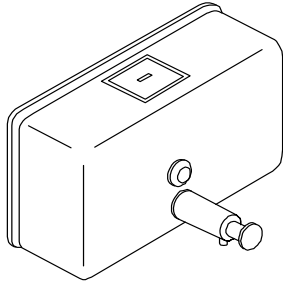
Effective Date October 1, 2011

Soap Dispensers

Models 6542 & 6562 (Components Manufactured 1993 and After), 6531, 6563 & 6583 where noted only

Part No.	Description	Kit Part Number	List Price
P19-212	Liquid Soap Valve (Complete) 6531	P15-408	\$ 25.80
P19-006	Sight Glass (Kit includes Service Kit, (5) per pack)	P15-405	\$ 9.20
P19-001	O-Ring (Prior to Dec `89)		\$ 0.35
P19-165	O-Ring (After Dec `89)		\$ 1.05
P19-140	Mounting Kit (incl. Back Plate, Screws & Key) 6542, 6562, 6583	P19-140	\$ 5.00
P19-213	Repair Kit for Valves P19-212 (incl. Spring, Housing, O-Ring, Duckbill Check & Rubber Washer)	P19-213	\$ 17.30
P15-449	ABS Liquid Soap Valve, 6563 ONLY		\$25.80



NOTE: Repair Kits are not available for older valves P19-134 & P19-159. Order new valve P19-212.

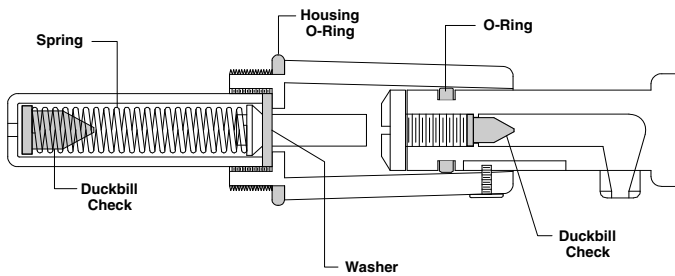

Soap Drawer Assemblies

With Liquid Soap Valve

Part No.	Used On Models	List Price
S01-476	120, 130, 131, 133, 186, 194, 1945, 641	\$ 152.00
A14-020	120-14, 130-14, 131-14, 133-14, 186-14, 194-14, 642	\$ 208.80
S01-478	643	\$ 94.50
S01-479	6437	\$ 130.80
S01-482	644	\$ 149.60
M44-047	Brass Nut 3/4"-28 Hex.	\$ 4.40

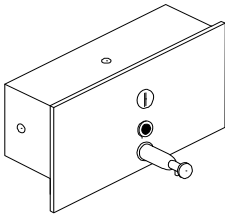
 Soap Valve For Soap Drawer Assemblies is P19-212 (see above).
 Repair Kit For P19-212 is P19-213 (see above).

Soap Dispenser Parts

Part No.	Used on Models	List Price
P15-079	Plastic Soap Tray for 9352, 9353, 9362, 9363	\$ 2.70
P15-460	Control Box for 6A00-11	\$86.50
P15-461	Key for 6A00-11	\$1.95
P15-462	Tube for 6A00-11	\$5.60
P15-463	Tank for 6A00-11	\$5.60

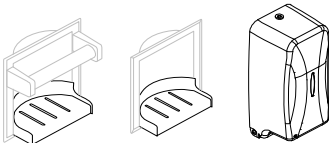

Effective Date October 1, 2011

Soap Dispensers

Models 6322, 6324 & 6326 (Components Manufactured 1993 and After), 6334

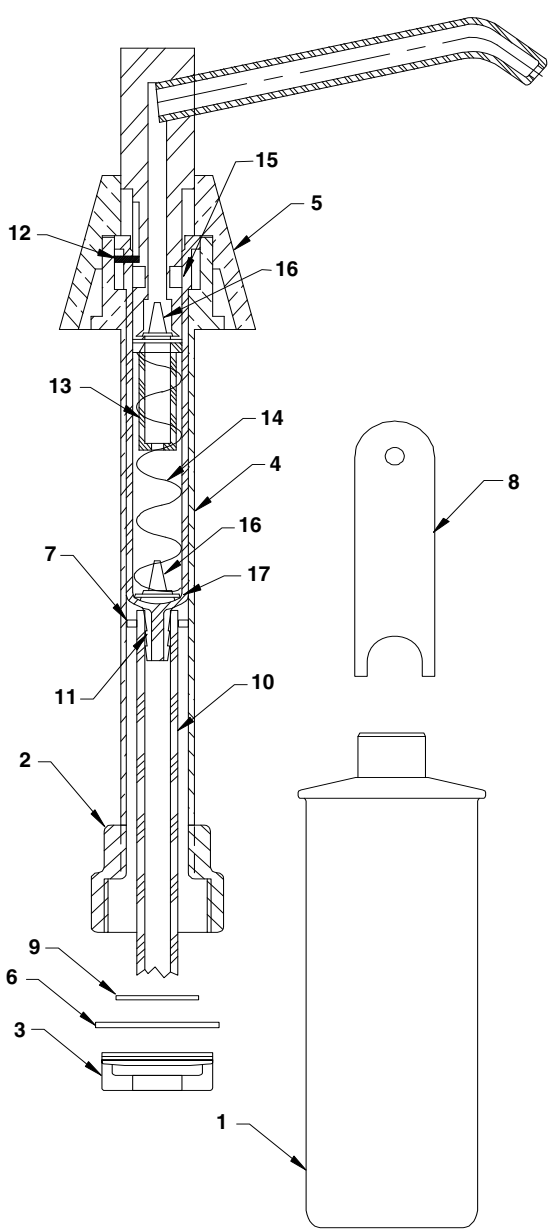

Item	Part No.	Qty	Description	Kit Part Number	List Price
1	P19-151	1	Metal Soap Cont. 16 oz.		\$ 24.30
	P10-287	1	Plastic Soap Cont. 16 oz.		\$ 4.05
	P19-227*	1	Plastic Soap Cont. 16 oz.		\$ 2.50
	P19-119	1	Plastic Soap Cont. 32 oz.	P15-406	\$ 9.15
Not Shown	P19-053	1	1" Spacer		\$ 5.20
Spout Kits:					
	P19-206	1	2.5" Spout		\$ 85.20
	P19-207	1	4" Spout		\$ 57.40
	P19-208	1	6" Spout		\$ 59.95
Spout Kits include 2, 3, 4, 5, 6, 9 PLUS P19-187 Kit					
2	P19-117	1	Adapter		\$ 1.40
3	P19-121	1	Wing Nut		\$ 0.70
4	P19-116	1	Shank-ABS Plastic		\$ 2.55
	P19-169	1	Shank - Chrome-Plated Brass		\$ 11.88
5		1	Escutcheon		
6		1	Washer, Steel		
9		1	Washer, Neoprene		
Repair Kit P19-187 includes:				P19-187	\$ 14.30
7		1	Cable Tie		
8	P19-118	1	Wrench		\$2.10
10		1	Supply Tube		
11		1	Cylinder		
12		1	Screw		
13		1	Plunger Spacer		
14		1	Compression Spring		
15		1	O-Ring		
16		2	Duckbill Check		
17		1	Washer		

* Model 6334 Only

Prices subject to change without notice.
Items may be changed or discontinued
without notice and without incurring obligation.

Effective Date October 1, 2011

Automatic Soap Dispenser (Manufactured after 8/24/07)

Model 6315 (No repair parts available for units manufactured before 8/24/07)

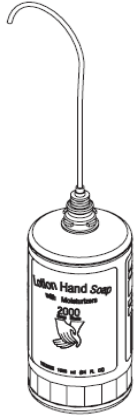
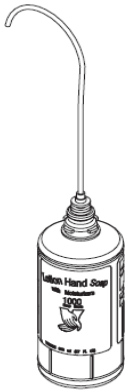
	Part No.	Qty	Description	List Price
 <p>P19-232A 54 oz., 2000 shot</p>	P19-232A	1	1 Case (4 Bottles) 54oz Lotion Soap with Moisturizer	\$108.00
	P19-232B	1	1 Case (4 Bottles) 27oz Lotion Soap with Moisturizer	\$64.00
 <p>P19-232B 27 oz., 1000 shot</p>	P19-231F	1	AC Adapter for Single Soap Dispenser	\$75.00
	P19-231G	1	AC Adapter for up to 4 Dispensers (requires 1 P19-231H per dispenser)	\$170.80
	P19-231H	1	Wire assembly (need 1 assembly for every dispenser. Max 4 per P19-231G)	\$25.90
	P19-231A	1	Spout Assembly	\$65.00
	P19-231B	1	C-Clip	\$1.50
	P19-231C	1	Motor Assembly	\$75.00
	P19-231D	1	Battery Box	\$35.00
	P19-231E	1	Clip - Bottle	\$1.50

P19-231F
(AC Adaptor for single soap dispenser)

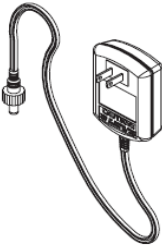

P19-231H
(Wire assembly)

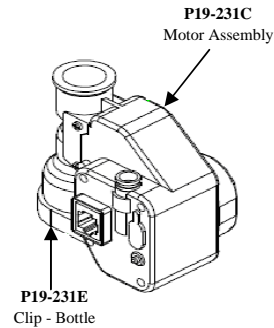

P19-231E
Clip - Bottle

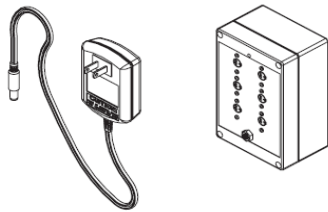

P19-231G
(AC adaptor for up to 4 soap dispensers)



P19-231A
Spout Assembly



P19-231B
C-Clip



P19-231D
Battery Box

Effective Date October 1, 2011

Grab Bar Parts

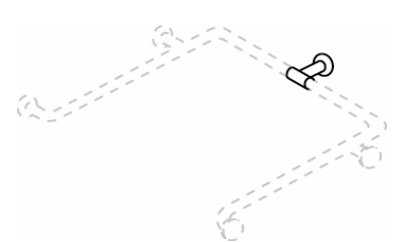

Part No.	Used On Models	List Price
U17-660	812 Coupling	\$ 85.60
U15-660	832 Coupling	\$ 106.90
U10-666	1" Escutcheon - Used on 852 Series	\$ 2.10
U12-666	1-1/4" Escutcheon - Used on 832 Series	\$ 2.50
U15-666	1-1/2" Escutcheon - Used on 812 Series	\$ 2.70

Retaining Bracket for Shower Seats

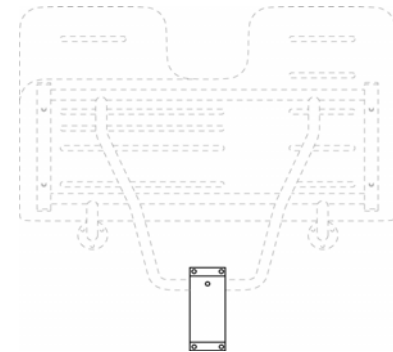

Part No.	Description	List Price
S01-255	Retaining Bracket for All Shower Seats Except 954, 9541, 9569	\$ 46.70
A18-052	Wall-Mtd. Support Assembly for 9569	\$ 40.30
P10-692	Phenolic seat only for 9569	\$ 242.50
P10-630	LLDPE seat only for 9557	\$ 100.50
P10-634	LLDPE seat only for 956 (left hand)	\$ 172.80
P10-635	LLDPE seat only for 9561 (right hand)	\$ 172.80

Shower Rods

Part No.	Description	List Price
P10-711	Swivel bracket ends, satin chrome plated zinc	\$ 28.50
P10-712	Swivel bracket ends, bright chrome plated zinc	\$ 28.50

*includes allen wrench, SS set screws, flathead stainless steel screws, and anchor plugs.

Effective Date October 1, 2011

Post Sets for Towel Bars

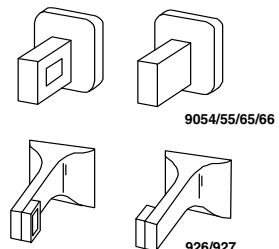
	Part No.	Description	List Price
	9054-P00000	9054	\$ 20.70
	9055-P00000	9055	\$ 24.30
	9065-P00000	9065	\$ 20.70
	9066-P00000	9066	\$ 24.30
	926-P00000	926	\$ 16.00
	927-P00000	927	\$ 16.00

Towel Dispenser Accessories

	Part No.	Description	List Price
	M08-001	Towel Pan for 2017, 225, 2252, 247, 2478 Towel Disp.; 2017, 2018, 2037, 237, 2038, 238 Towel/Waste Unit; 130, 155 Multi-Unit	\$ 32.80
	M08-005	Towel Pan for A01, 270 Multi Purpose Unit	\$ 88.00
	P10-689	Towel Dispenser Knob (white) and screw pack (5 per) for P10-561	\$ 9.10
	P10-561	Towel Dispenser Mechanism for 227 & 2277 Towel/Waste Unit; 2481, 2483, 2484 Roll Towel Disp.; Ps200, S08 Cabinet Assy.	\$ 135.00
	P15-394	Spring for P10-561 Towel Dispenser	\$ 0.60
	A17-003	Service kit for 236 Towel/Waste Unit. 2 Service part Towel dispenser center pulls, 4 Lip Trims, 1 set of instructions.	\$ 79.60
	P10-687	Cone for 236 Towel/Waste Unit.	\$ 5.33
	P10-697	Hands-Free Roll Towel Dispenser, Less Cover for 233 Towel/ Waste Unit	\$ 122.25
	P15-397	Cover for 2490	\$ 74.00
	P15-390	Key for 2490	\$ 1.10
	P15-450	Cover for 2494	\$ 41.00
	P15-451	Key for 2494 and 2497	\$ 1.10
	P15-452	AC Conversion Pack for 2494	\$ 70.00
	P15-453	Cover for 2495	\$ 84.00
	P15-454	Key for 2495 and 2496	\$ 1.10
	P15-457	Cover for 2497	\$ 44.00
	P15-458	Cover for 2496	\$ 42.00
	P15-459	AC Conversion Pack for 2496	\$ 140.00

Miscellaneous Parts

	Part No.	Description	List Price
	P18-078	Door latch for 2018, 2028, 2038, 2298 Towel/Waste Receptacle; 2443, 2448, 2478 Towel Dispenser; 3158, 3258 Waste Receptacle; 4738 Napkin Disp.; 5848 Seat Cover Disp.	\$ 1.45
	P10-695	Shield for 5900 Series Combination Units	\$ 16.10
	P18-116	Nylon Snap Rivet for P10-695	\$ 0.20
	P10-012	Mop Holder for 9933, 9934, 9953, 9954, 9955, 9983, 9984, 9985, 9986	\$2.90
	P18-106	Rivet for 9953,9954,9955	\$0.20
	P10-642	Magnetic Catch for 175	\$3.20



TEL: 1-800-BRADLEY FAX: 262-251-5817
www.bradleycorp.com

Effective Date October 1, 2011

COLLARS: Recessed to Semi-Recessed

Part Number	Used On Models	List Price
S08-211	130, 155, 170, 175, 334, 344, 346	\$ 121.00
S08-220	2291, 244, 3251	\$ 125.00
S08-230	1471, 2441	\$ 126.00
S08-225	2017, 2018	\$ 165.00
S08-252	2027, 2028	\$ 247.00
A10-002	2037, 2038	\$ 237.00
S08-209	225	\$ 333.00
S08-258	2251	\$ 263.00
S08-244	2252	\$ 239.00
A10-001	227, 2271	\$ 238.00
A11-037	2277	\$ 224.00
S08-228	229	\$ 231.00
S08-222	2297, 2298, 2447, 2448, 3257, 3258	\$ 175.00
S08-210	234, 235 prior to March 2011	\$ 175.00
A10-007	234, 235 after March 2011	\$ 323.00
S08-205	236, 237, 238	\$ 171.00
S08-243	247	\$ 211.00
A11-029	2481	\$ 204.00
A10-004	270	\$ 201.00
S08-242	315-35	\$ 223.00
S08-257	3157, 3158	\$ 227.00
S08-226	4017, 4018	\$ 125.00
A11-031	2442, 2443, 4737, 4738	\$ 150.00

Collars can only be used with fully-recessed units.



TEL: 1-800-BRADLEY FAX: 262-251-5817
www.bradleycorp.com

Effective Date October 1, 2011

COLLARS: Recessed to Surface-Mtd.

Part Number	Used On Models	List Price
S08-207	130, 155, 170, 175, 334, 344	\$ 108.00
S08-208	2291, 244, 3251	\$ 110.00
S08-219	1471, 2441	\$ 84.00
S08-248	2017, 2018	\$ 262.00
S08-251	2027, 2028	\$ 222.00
A11-018	2037, 2038	\$ 313.00
S08-233	225	\$ 420.00
A11-005	2251	\$ 269.00
S08-241	2252	\$ 356.00
A11-008	227, 2271	\$ 343.00
A11-038	2277	\$ 265.00
S08-227	229	\$ 144.00
S08-235	2297, 2298, 2447, 2448, 3257, 3258	\$ 188.00
S08-201	234, 235 prior to March 2011	\$ 157.00
A11-044	234, 235 after March 2011	\$ 323.00
A11-002	236, 237, 238	\$ 253.00
A11-007	2442, 2443, 4737, 4738	\$ 167.00
A11-012	247	\$ 217.00
A11-004	2478	\$ 227.00
S08-256	2481	\$ 228.00
A11-041	270	\$ 419.00
S08-229	315-35	\$ 411.00
A11-017	3157, 3158	\$ 271.00
A11-003	346	\$ 168.00
A11-039	4017	\$ 186.00
A11-019	4018	\$ 195.00
A11-040	407	\$ 129.00
S08-245	990	\$ 247.00

Collars can only be used with fully-recessed units.

Effective Date October 1, 2011

Shower Rod Flanges

Part No.	Used On Models	Description	List Price
701-600	953	1" Exposed Flange	\$ 2.90
701-600A	9531	1-1/4" Exposed Flange	\$ 2.90
9532-F00000	9532	1" Exposed Flange	\$ 12.45
P10-482	9538	1" Concealed Flange	\$ 2.30
U10-666	9538	1" Escutcheon	\$ 2.10
P10-482A	9539	1-1/4" Concealed Flange	\$ 2.65
U12-666	9539	1-1/4" Escutcheon	\$ 2.50

Baby Changing Stations

Part No.	Used On Models	Description	List Price
9611-PS902566	961, 9611, 9612	Replacement Strap	\$ 46.40
P11-021	961, 9611, 9612, 962-11, 962	Case of 500 White Liners	\$ 140.00

Miscellaneous

Part No.	Used On Models	Description	List Price
P10-526*	All Models W/Locks	Key	P15-398
P18-073	All Models W/Torx Head W/Pin Security Screws	Torx Tool Kit	\$ 53.40
330-074	All Mirrors W/H-Hangers	Mirror Release Tool	\$ 29.70
P10-636	All Models W/Locks	Turn Knob Key	\$ 2.65

*Refer to Lock & Cam Part No. Reference for Kit No.

Effective Date October 1, 2011

Mirror Glass

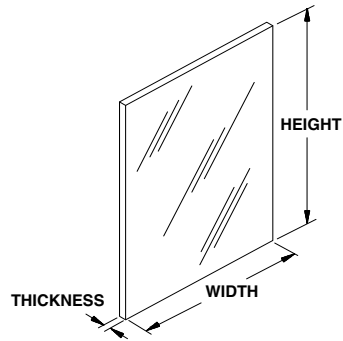

Part No.	Used On Models	Size (Inches)			List Price
		Width	Height	Depth	
P13-002	130, 133, 155	14-13/16	17-13/16	1/4	\$ 21.40
P13-008	175	16-13/16	30-3/8	1/4	\$ 42.80

Replacement mirror glass sizes for 780, 7805, 781, 7815, 740, 7405, 782 angle frame & channel frame mirrors.

Mirror glass size - 1" less than overall size mirror; (example: 780-16 x 24 mirror glass would be 15 x 23)

Mirror Accessory	Large Mirrors -100" Plus				
A18-054	Support Bracket Kit	2-1/2	3-3/4	1	\$ 52.40
Kit includes: two brackets and instruction sheets.					
P10-719	Frameless Mirror Clip Kit - Set of (4). Used on 747, 747W				\$ 12.00
Mirror Parts					
P10-626	Plastic Rosette-Large				\$ 1.00
P10-627	Plastic Rosette-Small				\$ 1.00

Replacement Shelves

For Medicine Cabinets

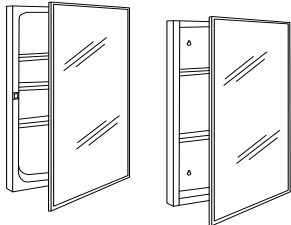
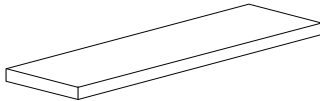

Part No.	Used On Models	Description			List Price
P15-380	9663	Stainless			\$ 12.20
P15-385	9664	Stainless			\$ 13.50

Lock & Cam Part Number Reference

Model No.	Lock & Cam Part No.	List Price	Model No.	Lock & Cam Part No.	List Price
130-000000	P10-596 (door)	\$ 9.70	334-000000	P10-568	Service Kit
130-000000	P10-558 (soap disp)	Service Kit	344-000000	P10-568	Service Kit
1471-000000	P10-558	Service Kit	346-000000	P10-568	Service Kit
1471-1100000	P10-558	Service Kit	401 Series	P10-558 (door)	Service Kit
155-000000	P10-596	\$ 9.70	401 Series	P10-519 (coin box)	\$ 6.60
170-000000	P10-066	\$ 19.55	4017-000000	P10-558 (door)	Service Kit
194-000000	P10-565 (towel disp)	Service Kit	4017-000000	P10-519 (coin box)	\$ 6.60
194-000000	P10-558 (soap disp)	Service Kit	4018 Series	P10-558 (door)	Service Kit
198-000000	P10-565	Service Kit	4018 Series	P10-519 (coin box)	\$ 6.60
1981-000000	P10-558	Service Kit	402-000000	P10-558 (door)	Service Kit
1985-000000	P10-565	Service Kit	402-000000	P10-519 (coin box)	\$ 6.60
2017-000000	P10-565	Service Kit	403 Series	P10-558 (door)	Service Kit
2027-000000	P10-565	Service Kit	403 Series	P10-519 (coin box)	\$ 6.60
2037-000000	P10-565	Service Kit	404 Series	P10-558 (door)	Service Kit
225-000000	P10-558	Service Kit	404 Series	P10-519 (coin box)	\$ 6.60
2251-000000	P10-558	Service Kit	407 Series	P10-558 (door)	Service Kit
2252-000000	P10-558	Service Kit	407 Series	P10-519 (coin box)	\$ 6.60
227-000000	P10-558 (door)	Service Kit	426 Series	P10-558 (door)	Service Kit
227-000000	P10-568 (W/R)	Service Kit	426 Series	P10-519 (coin box)	\$ 6.60
2271-000000	P10-558 (door)	Service Kit	428 Series	P10-558 (door)	Service Kit
2271-000000	P10-568 (W/R)	Service Kit	428 Series	P10-519 (coin box)	\$ 6.60
2277-000000	P10-565	Service Kit	4721-150000	P10-565	Service Kit
229-000000	P10-558	Service Kit	4722-101500	P10-565	Service Kit
2291-000000	P10-558	Service Kit	4722-150000	P10-565	Service Kit
2297-000000	P10-565	Service Kit	4731-150000	P10-565	Service Kit
233-000000	P10-558 (door)	Service Kit	4737-000000	P10-558	Service Kit
233-000000	P10-568 (W/R)	Service Kit	4781-150000	P10-567	Service Kit
234-000000	P10-568	Service Kit	4791-150000	P10-567	Service Kit
235-000000	P10-558, P10-568	Service Kit	5402-000000	P10-558	Service Kit
236-000000	P10-558 (door)	Service Kit	5412-000000	P10-558	Service Kit
236-000000	P10-568 (W/R)	Service Kit	5422-000000	P10-558	Service Kit
237-000000	P10-558 (door)	Service Kit	5424-000000	P10-558	Service Kit
237-000000	P10-568 (W/R)	Service Kit	5425-000000	P10-565	Service Kit
238-000000	P10-558	Service Kit	583-000000	P10-567	Service Kit
244-000000	P10-558	Service Kit	584-000000	P10-558	Service Kit
2441-000000	P10-558	Service Kit	5847-000000	P10-558	Service Kit
2442-000000	P10-565	Service Kit	591-000000	P10-558	Service Kit
2447-000000	P10-565	Service Kit	5911-000000	P10-558	Service Kit
247-000000	P10-558	Service Kit	5912-000000	P10-558	Service Kit
2481-000000	P10-558	Service Kit	592-000000	P10-558	Service Kit
250-150000	P10-565	Service Kit	5921-000000	P10-558	Service Kit
250-330000	P10-565	Service Kit	5922-000000	P10-558	Service Kit
251-150000	P10-621	Service Kit	5932-000000	P10-558	Service Kit
252-000000	P10-565	Service Kit	594-000000	P10-558	Service Kit
270-000000	P10-558	Service Kit	5942-000000	P10-558	Service Kit
315-350000	P10-558	Service Kit	643-000000	P10-558	Service Kit
3157-000000	P10-565	Service Kit	6437-000000	P10-558	Service Kit
3251-000000	P10-558	Service Kit	644-000000	P10-558	Service Kit
3257-000000	P10-565	Service Kit	9495-000000	P10-567	Service Kit

**P10-526 key unlocks
all locks except
P10-519**

Service Kits

Description	Kit Number	List Price
Key P10-526 (5 keys per kit)	P15-398	\$ 8.70
P10-558 lock, clip, & key kit	P15-399	\$ 6.70
P10-565 lock, clip, & key kit	P15-400	\$ 6.70
P10-567 lock, clip, & key kit	P15-401	\$ 6.70
P10-568 lock, clip, & key kit	P15-402	\$ 6.70
P10-723 lock, clip, & key kit	P15-465	\$ 7.60
P10-621 lock, clip, & key kit	P15-404	\$ 6.70

Effective Date October 1, 2011

Kit Reference Guide

Part No.	Description	Quantity	Kit No.	List Price	Ref. Page
P11-030	Waxed Paper Liner	500	P11-022	\$ 225.00	3
P10-526	Key	5	P15-398	\$ 8.70	14
P10-558	Lock, Clip, & Key	1	P15-399	\$ 6.70	14
P10-565	Lock, Clip, & Key	1	P15-400	\$ 6.70	14
P10-567	Lock, Clip, & Key	1	P15-401	\$ 6.70	14
P10-568	Lock, Clip, & Key	1	P15-402	\$ 6.70	14
P10-596	Lock, Clip, & Key	1	P15-403	\$ 20.70	14
P10-621	Lock, Clip, & Key	1	P15-404	\$ 6.70	14
P19-006	Sight Glass	5	P15-405	\$ 9.20	7
P19-119	32 oz. Plastic Soap Bottle	1	P15-406	\$ 9.15	8
P10-571	Toilet Tissue Spindle	1	P15-407	\$ 4.20	6
P19-212	Soap Valve	1	P15-408	\$ 25.75	7
P19-140	Mounting Kit (Backplate, Screws, Key)	1	P19-140	\$ 5.00	7
P19-213	Repair Kit - Soap Valves	1	P19-213	\$ 17.25	7
P19-187	Repair Kit - Saop Dispenser	1	P19-187	\$ 14.25	8