

- ADA Compliant
- 3 Standard Models (30", 60", 90")
- OmniDeck with Multi-Height Vessel Sinks
- Sink(s) and Deck are Constructed of Terreon® or Terreon®RE Solid Surface Material
- Available in 32 Colors

## Product Features

- ADA-compliant trap cover
- Designer stainless steel mounting brackets
- Pre-mounted Terreon or TerreonRE vessel sinks
- Continuous bull nose apron
- Centershank faucet drilling
- ADA-compliant offset tailpiece and chrome-plated strainer
- Contoured covered backsplash

## Construction

### Deck/Sink

Constructed of Terreon, a densified solid surface material composed of polyester resin, or TerreonRE, a densified solid surface material composed of a bio-based resin and preconsumer recycled granules. Terreon and TerreonRE are resistant to chemicals, stains, burns and impact. Surface damage can be easily repaired with everyday cleansers or fine grit abrasives. Terreon and TerreonRE are certified by NAHB to meet ANSI Z124.3, Z124.6 and ANSI/ICPA SS-1-2001. Terreon and TerreonRE are GREENGUARD® certified as low-emitting materials and feature a 10-year warranty.

### Trap Cover and Brackets

ADA-compliant trap covers constructed of 300 Series 22 gauge stainless steel. Available in smooth or textured (5WL) finishes. Mounting brackets constructed of 14 gauge stainless steel and feature a bead blast finish.

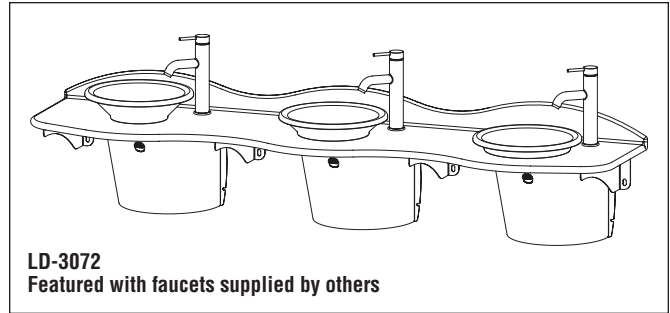

## Code Compliance and Certifications

### ANSI Standards

Terreon and TerreonRE are NAHB certified to meet ANSI Z124.3, Z124.6 and ANSI/ICPA SS-1-2001.

### cUPC Approval:

Terreon OmniDecks are Uniform Plumbing Code (UPC), International Plumbing Code (IPC) and National Plumbing Code of Canada (NPC) approved through the International Association of Plumbing and Mechanical Officials (IAPMO). Manufactured in compliance with AIGC 156, CSA B45 Series (R08) & ASME A112.18.1/CSA B125.1.

- This plumbing fixture is designed for hand washing only. It is not intended to dispense water for human consumption through drinking or for preparation of food or beverages.

### Standard Mounting Height

To comply with ADA, the rim height of at least one sink, must be 33" or 34" above the finished floor. To be completely ADA compliant, the Terreon and TerreonRE OmniDecks must be equipped with ADA-compliant faucets and trap cover. Always review local codes for compliance.

## Specifications

The Terreon and TerreonRE OmniDecks, Model LD-3072/STD, can accommodate multiple users. Model LD-3072 OmniDecks feature a solid surface deck with multi-height vessel sinks. Vessel rim heights available in 33" (ADA), 34" (ADA), and 35". See technical drawings for additional information.

DISCONTINUED



Verify all rough-in dimensions prior to installation.

Consult local and national codes. Conformity and compliance to local and national codes is the responsibility of the installer.

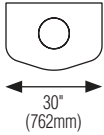

**Model (select one):**

**3072-1** 

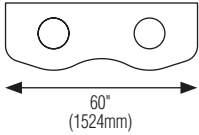
**3072-2** 

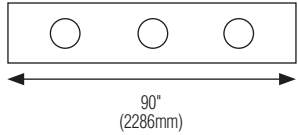
**3072-3** 

**Standard Selections** (Must select one from each category)

**Vessel Height Above Finished Floor (select one):**

Vessel 1 rim height  33"  34"  35"

Vessel 2 rim height  33"  34"  35"

Vessel 3 rim height  33"  34"  35"

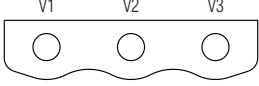

**Faucet Drilling:**

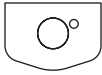
**SHANK RT** Right of Sink(s)  

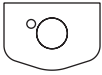
**SHANK LT** Left of Sink(s)  

**NFD** (No Faucet Drilling)  

Vessel 1

Vessel 2

Vessel 3

**Rear center mount not available.**

**Color of Terreon Deck (select one):**

**Standard Colors:**

**BONE** Mesa Bone  **E-GRAY** Empire Gray  **LANNON** Lannonstone  **SAND** Sandtrap

**CHAR** Charcoal Gray  **FIESTA** Fiesta  **LONDON** London Gray  **WHT-SAND** White Sand

**COBBLE** Cobblestone  **GRAPH** Graphite  **O-TAUPE** Organic Taupe

**DS-WHT** Designer White  **JADE** Jade  **PEPPERED** Peppered White

**Designer Colors (available at additional charge) (non-cancelable, non-returnable):**

**ARC-CHIP** Arctic Chip  **CORN** Cornfield  **MYSTIC-M** Mystic Moss  **STAR-D** Stardust

**BLUESKY** Blue Sky  **HILLSIDE** Hill Side  **RIVER** Riverstone

**COFFEE** Coffee Bean  **MOUNTAIN** Mountain Top  **S-SAGE** Summer Sage

**TerreonRE Colors (available at additional charge):**

**BIRCH-BARK** Birch Bark  **FERN** Fern  **MOONDUST** Moondust  **OCEAN-MIST** Ocean Mist

**DUSK** Dusk  **MAIZE** Maize  **OAT** Oat  **OLIVE** Olive

**Will Tempered Water Be Supplied to This Unit (select one):**

Note: This question must be answered to determine bowl color (see below).

**TEMP** Tempered (less than 110°F or 45°C)  **NO-TEMP** Not Tempered

**Color of Terreon Vessel Sink (select one):**

**BONE** Mesa Bone  **O-TAUPE** Organic Taupe  **LONDON** London Gray

**DS-WHT** Designer White  **SAME** Same as Deck (Requires Tempered Water)

**Single-Station Trap Cover (select one):**

**LD-TRAP-S** Smooth Stainless Steel Trap Cover (22-gauge)  **LD-TRAP-T** Textured Stainless Steel Trap Cover (5WL 22-gauge)  **NTC** No Trap Cover

**Mounting Options (select one):**

**BRKT** Stainless Steel Mounting Bracket(s)  **NONE** Customer Supplied Mounting

**P-Trap Options (select one):**

**P-Trap-P** Polypropylene  **P-Trap-C** Chrome-plated brass  **NONE** Customer-supplied traps

DISCONTINUED