

# Installation

## LD-4010

### OmniDeck™ - 4000 Series

#### Table of Contents

Supplies Required . . . . .	2
Components . . . . .	3-4
Dimensions . . . . .	5-6
Rough-Ins . . . . .	7
Installation . . . . .	8
Cleaning and Maintenance . . . . .	9

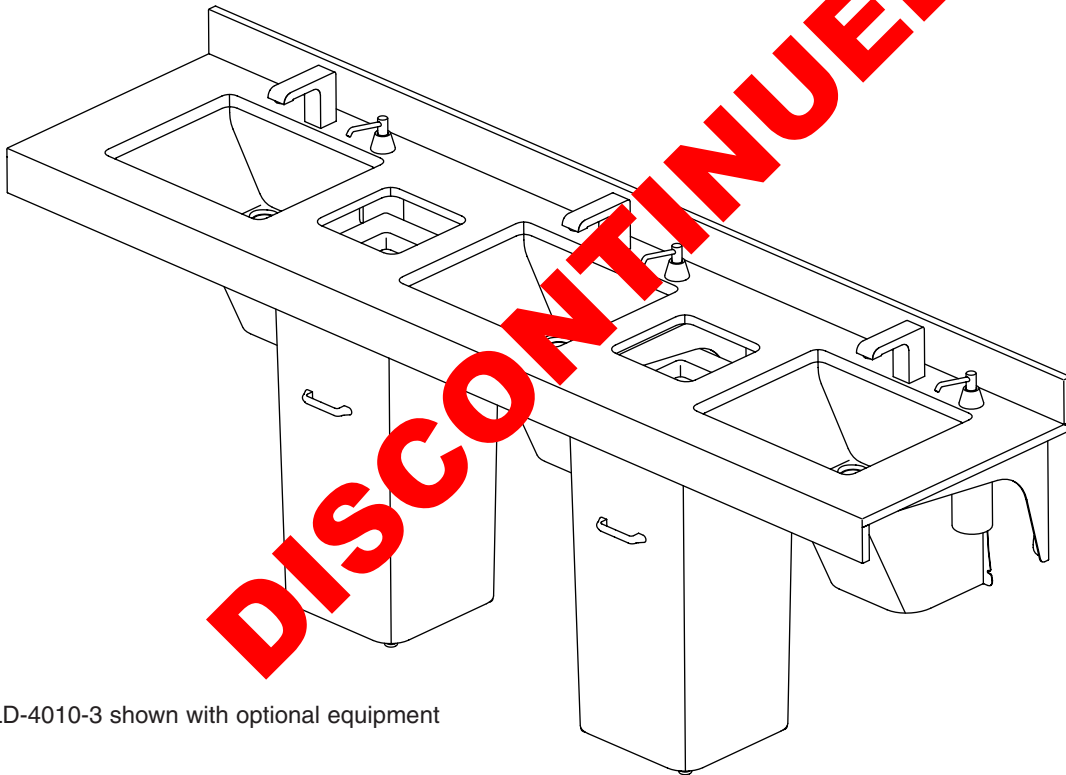

LD-4010-3 shown with optional equipment

## IMPORTANT!

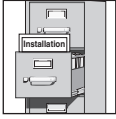

Read this entire installation manual to ensure proper installation. When finished with the installation, file this manual with the owner or maintenance department. Compliance and conformity to local codes and ordinances is the responsibility of the installer.



Separate parts from packaging and make sure all parts are accounted for before discarding any packaging material. If any parts are missing, do not begin installation until you obtain the missing parts.

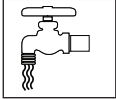

Make sure that all water supply lines have been flushed and then completely turned off before beginning installation. Debris in supply lines can cause valves to malfunction.

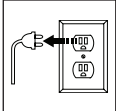

Turn OFF electrical power to the electrical outlets, then unplug all electrical units prior to installation. Electrical power MUST remain off until installation is completed. After installation is complete, turn on the water supply first, then turn on the electrical power.

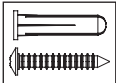

Hardware supplied by installer must be appropriate for wall construction. Wall anchors used must have a minimum pull-out rating of 1,000 lbs.



Product warranties and service parts information may be found on our web site at [bradleycorp.com](http://bradleycorp.com).

DISCONTINUED

### Supplies Required (by others)

- ½" Nominal copper tubing for hot/cold or tempered supply piping
- 1½" NPT drain piping
- PC-Concrete™ injectable repair and anchoring epoxy or equivalent
- For Optional Mounting Brackets: ⅜" wall anchors and fasteners
- For Optional Trap Cover: four #10 wall anchors and fasteners (for each cover)
- Screen filter(s) as needed, if not included with faucet(s)

# Optional Components

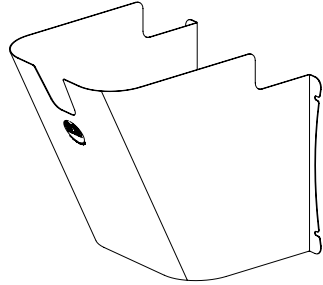

Trap Cover for Rectangular Undermount (S45-2708)

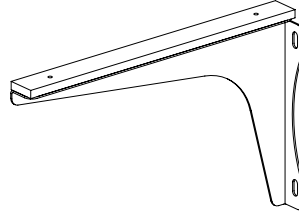

Left-hand Mounting Bracket with Mounting Strip (S45-2452LH)

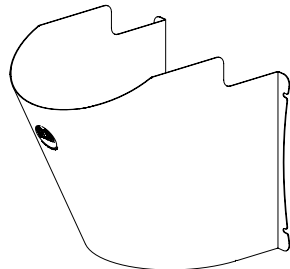

Trap Cover for Spherical Undermount (S45-2709)



Right-hand Mounting Bracket with Mounting Strip (S45-2452RH)

Strainer and ADA Offset Tailpiece (269-1751)

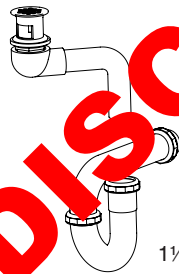

1½" Polypropylene P-trap (269-1697)

or

1½" Polished Chrome-Plated Brass P-trap (S29-094)

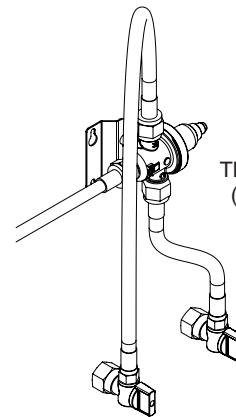

TMA Prepack (S45-2703)

- Waste Receptacle with Textured Lid
- Putty (S50-372)
- Coal (S50-372B)
- Handle Repair Kit (S65-244)
- Base Leveler Repair Kit
- Stainless Steel (S65-245)
- Plastic (S65-287)

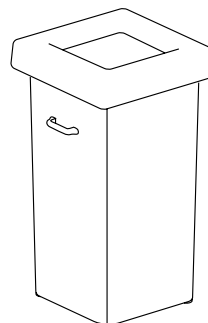

**DISCONTINUED**

# Optional Components

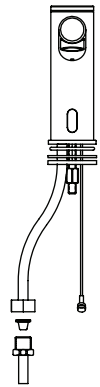

IR-DCD Faucet (S53-336)

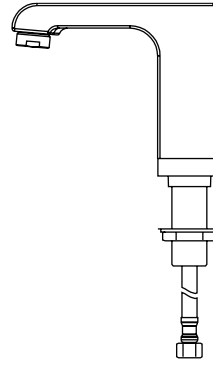

CAP-DCA Faucet (S53-334)

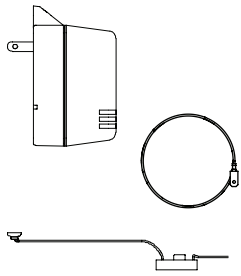

Plug-in transformer option (PT) includes Transformer (S53-338), Adapter (S53-339), and Grounding Kit (S53-349) for CAP-DCG and CAP-DCA Faucets

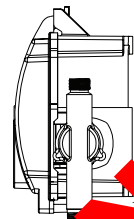

Battery Base for CAP-DCA and CAP-DCG Faucets

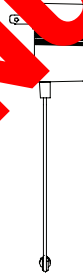

Plug-In Transformer Option (PT) for IR-DCD Faucet (S53-337)

**DISCONTINUED**

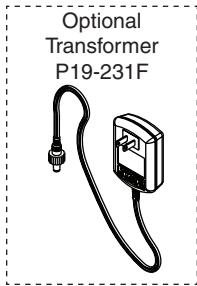

Optional Transformer P19-231F

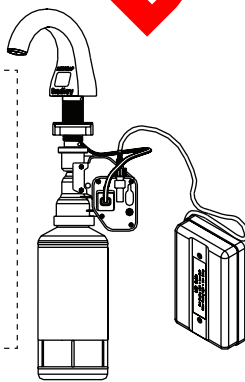

6315-KT0000 Soap Dispenser Kit (batteries and 1000-shot soap included)

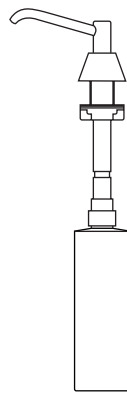

6324 Soap Dispenser, Plastic Globe (16-oz.)  
6324-67 Soap Dispenser, Stn. Steel Globe (16-oz.)  
6324-68 Soap Dispenser, Plastic Globe (32-oz.)



6334 Soap Dispenser

**Dimensions**



Dimensions for three-station lavs are shown and are for reference only. Dimensions for other configurations are similar.

**LD-4010 with Evero Rectangular Undermount Bowl**

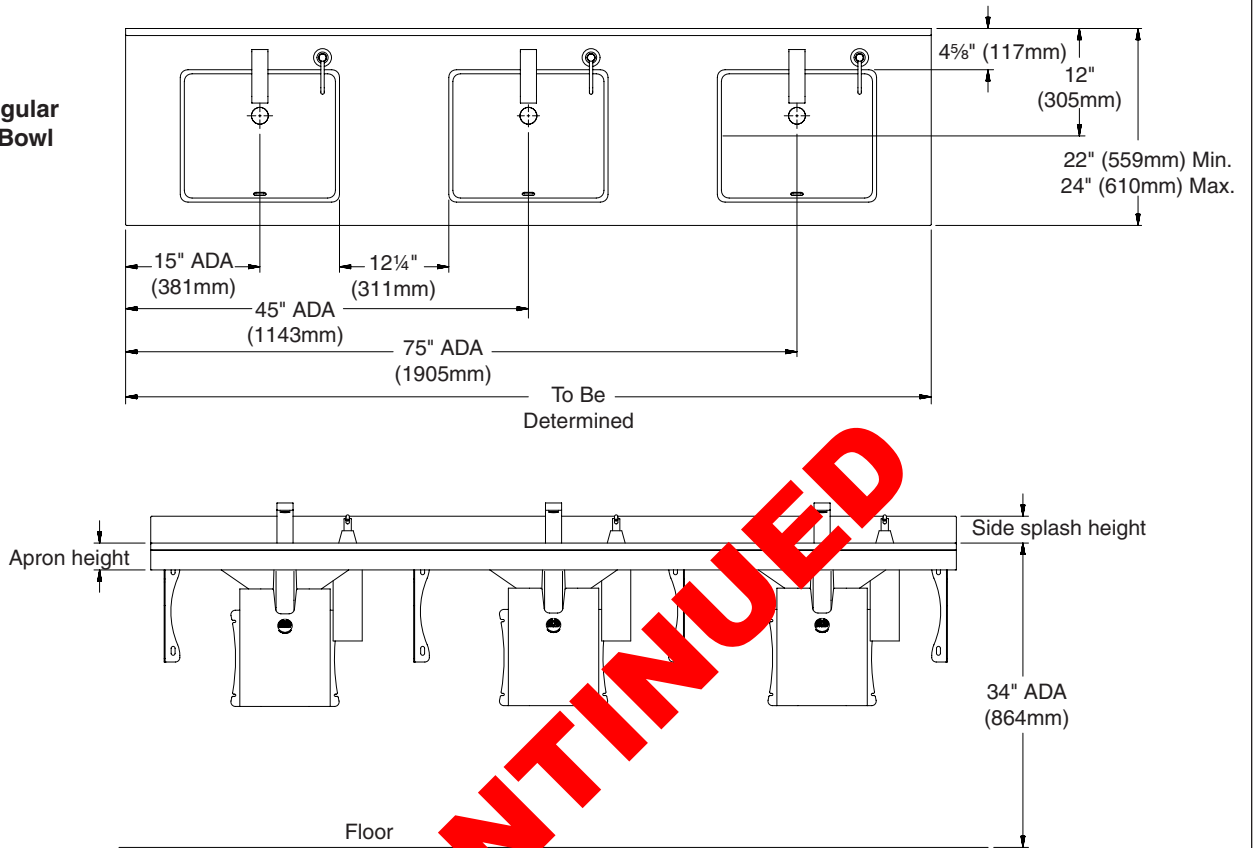

**LD-4010 with Stainless Steel Spherical Undermount Bowl**

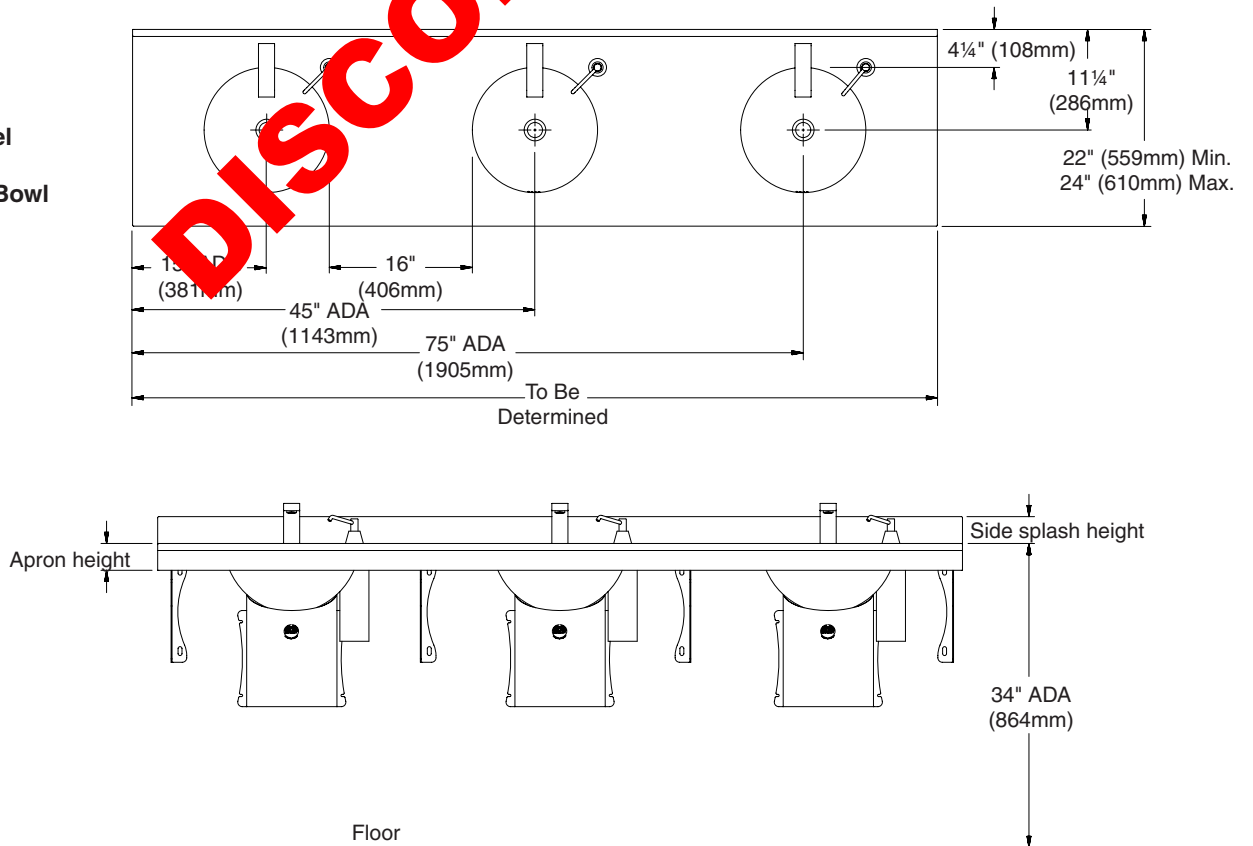

DISCONTINUED

### Dimensions - Side View

**Standard Height  
(Evero Rectangular  
Undermount Bowl)**

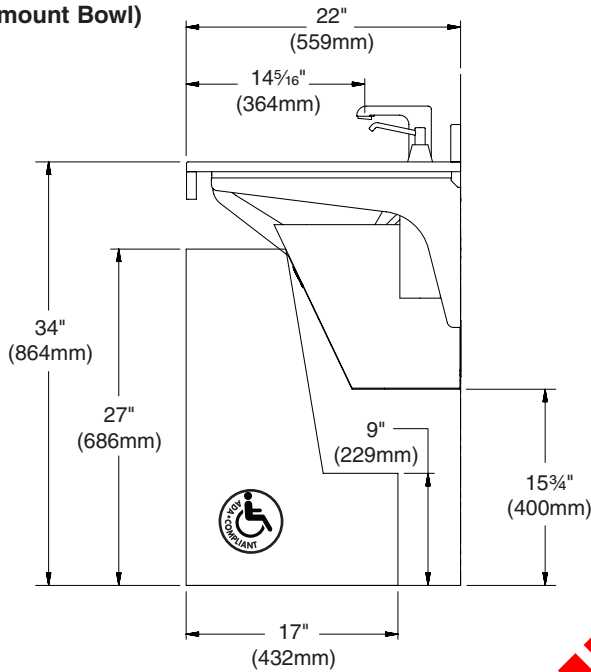

**Standard Height  
(Stainless  
Steel Spherical  
Undermount Bowl)**

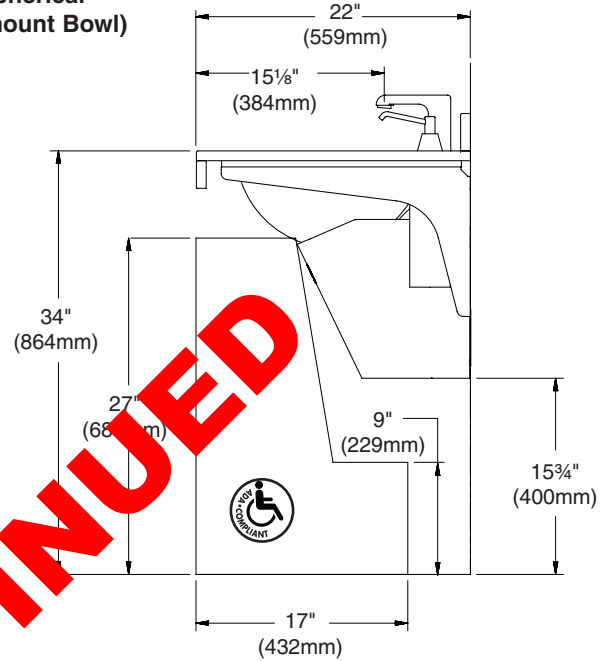

**Juvenile Height  
(Rectangular  
Undermount Bowl)**

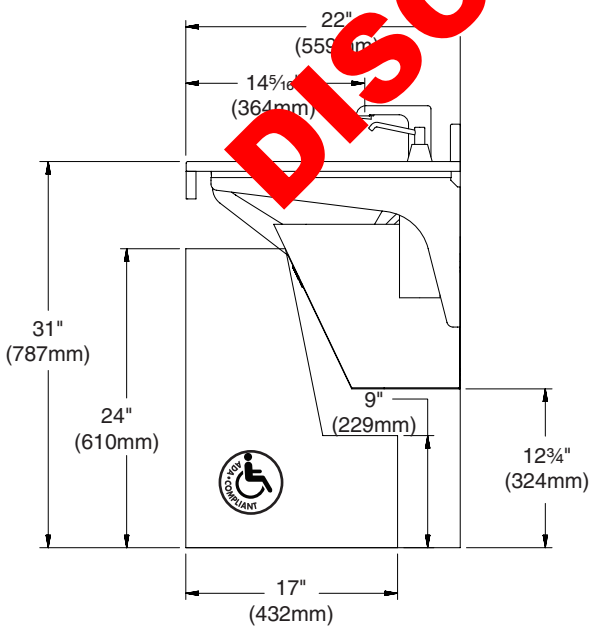

**Juvenile Height  
(Spherical  
Undermount Bowl)**

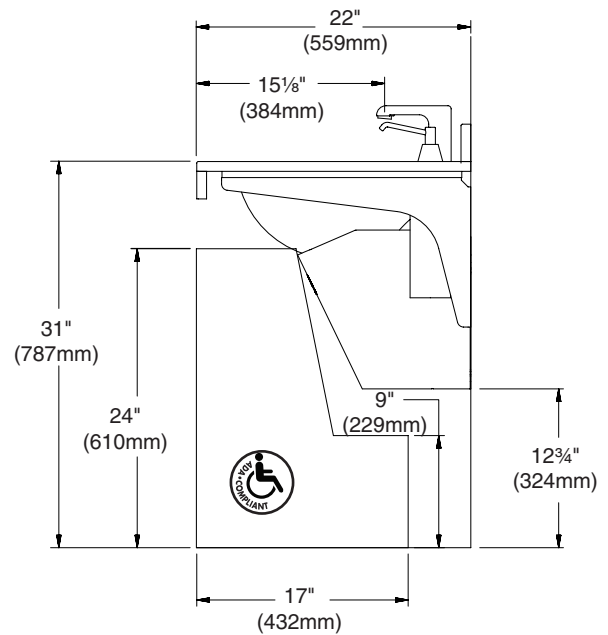

**DISCONTINUED**

# 1 Rough-Ins



Typical bowl deck installation is shown. Other bowl configurations are similar. Mounting bracket locations will vary depending on deck configuration.



Juvenile height counter surface mounting is 31" (787mm) max. Adjust all other juvenile height mounting locations accordingly.



Rectangular undermount trap cover is shown. Stainless steel spherical trap cover rough-in is similar.

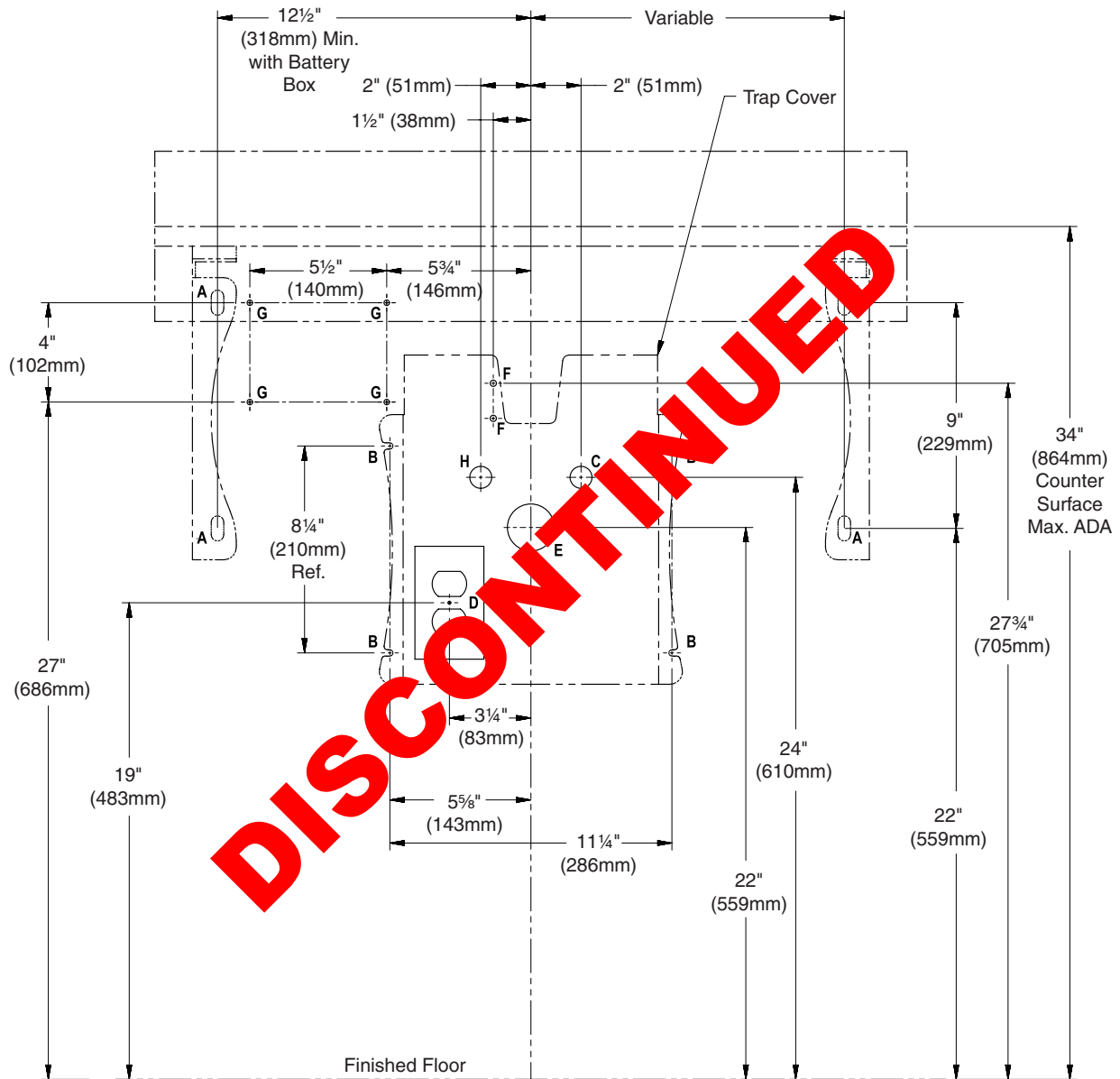

DISCONTINUED

Code	Description	Qty.
A	3/8" Bracket Anchors With a Min. Pull-Out Force of 1,000 Lbs. (Reinforce Wall at Anchor Points)	2 per bracket
B	#10 Wall Anchors and Screws	4
H, C	1/2" Nominal Copper Tubing for Hot/Cold Supplies (or Tempered Line), Stub-Out 2" from Wall	2
D	110V GFI Protected Electrical Outlet (AC Option Only)	1
E	1 1/2" NPT Drain, Stub-Out 2" from Wall	1
F	#10 Anchors and Screws (TMA Option Only)	2
G	1/4" Wall Anchors and Screws (Provided) (CAP-DCG, CAP-DCA and IR-DCD Faucet Options Only)	4

## 2 Installation



Apply PC-Concrete injectable repair and anchoring epoxy (or equal) to the top of the mounting strips (left-hand bracket shown).

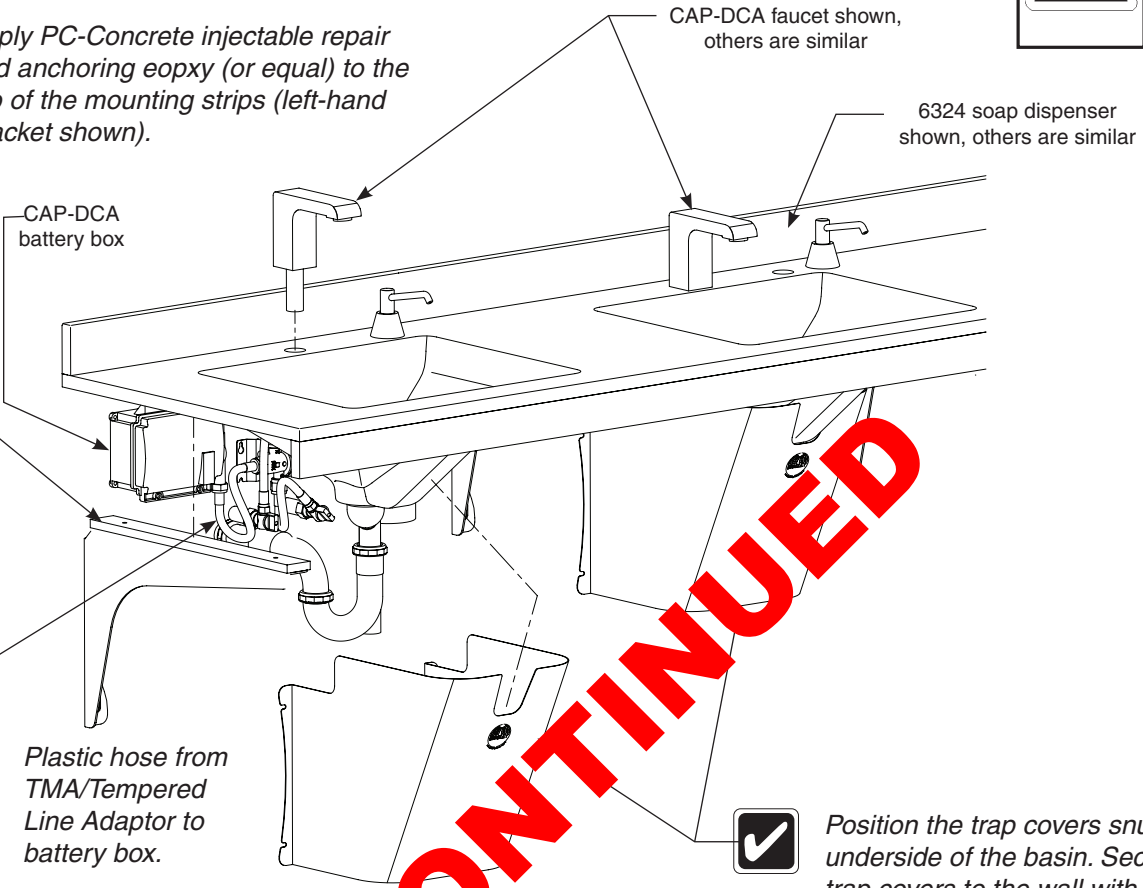

Plastic hose from TMA/Tempered Line Adaptor to battery box.



Position the trap covers snug to the underside of the basin. Secure the trap covers to the wall with four #10 fasteners (supplied by installer).

**DISCONTINUED**

### Drain and P-trap (view from top of bowl)

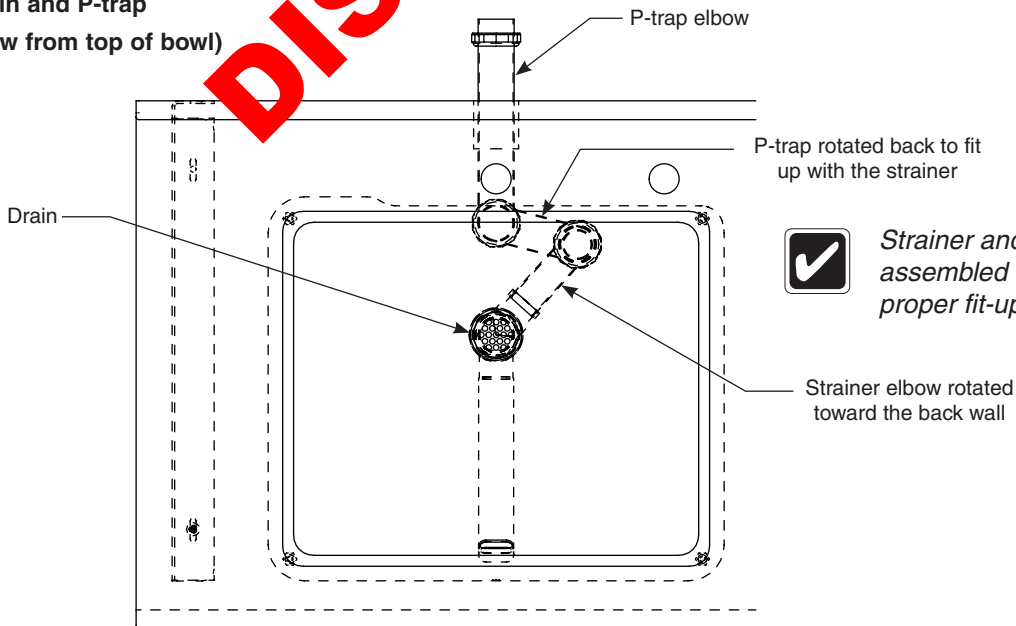

Strainer and P-trap to be assembled as shown for proper fit-up of trap cover.



## Cleaning and Maintenance for Evero

**Material Description:** Evero Natural Quartz Material is made from a blend of acrylic modified bio-based polyester resin, natural quartz, granite, and other exotic minerals and is resistant to chemicals, stains, burns and impact. Surface damage can be easily repaired with everyday cleansers or fine grit abrasives.

**Routine Cleaning:** For regular cleaning, use standard commercial or household products such as Simple Green®, Creamy Cleanser brand, Formula 409® or Windex®.

**Stubborn Stains:** Remove tough stains, with non abrasive cleaners and pads such as a white Scotch Brite® pad and Lysol®.

## Special Situations for Evero Material

**Hard Water Deposits:** Remove hard water deposits with a mild solution of vinegar and water. Always rinse the unit thoroughly after cleaning.

**Restoring the surface:** Refresh and restore the rich surface with a color enhancer such as Tenax® Ager, if needed.

**NOTICE!** Do not use strong acid or alkaline chemicals and cleansers to clean Evero. If these chemicals come in contact with the surface, wipe them off immediately and rinse with soapy water. Avoid contact with harsh chemicals such as paint remover, bleach, acetone, etc. Avoid contact with hot pans and objects.

**Repair Kits:** Evero repair kits are available. Contact your Bradley representative or distributor for part numbers and pricing. Repair kits are made to order and have a shelf life of 30 days.



*Evero is a unique, cast solid surface material. Aggregate flow and distribution as well as shades of color can vary from product to product creating natural characteristics.*

## Cleaning and Maintenance for Stainless Steel

**Material Description:** Stainless steel is extremely durable, and maintenance is simple and inexpensive. Proper care, particularly under corrosive conditions, is essential. Always start with the simplest solution and work your way toward the more complicated.

**Routine cleaning:** Daily or as often as needed use a solution of warm water and soap, detergent, or ammonia. Apply the cleaning solution per the manufacturer's instructions and use a soft cloth or sponge to avoid damaging the finish.

**Stubborn Stains:** To remove stains from stainless steel use stainless steel cleaner and polish such as Ball® stainless steel cleaner or a soft abrasive. Always follow the manufacturer's instructions and apply in the same direction as the polish lines.

**NOTICE!** Never use ordinary steel wool or steel brushes on stainless steel. Always use stainless steel wool or stainless steel brushes.

**Fingerprints and Smears:** To remove fingerprints and smears use a high quality stainless steel cleaner and polish in accordance with the manufacturer's instructions. Many of these products leave a protective coating that helps prevent future smears and fingerprints.

**Grease and Oil:** To remove grease and oil use a quality commercial detergent or caustic cleaner. Apply in accordance to the manufacturer's instructions and in the direction of the polish lines.

**Precautions:** Avoid prolonged contact with chlorides (bleaches, salts), bromides (sanitizing agents), thiocyanates (pesticides, photography chemicals, and some foods), and iodides on stainless steel equipment, especially if acid conditions exist.

**NOTICE!** Do not permit salty solutions to evaporate and dry on stainless steel.

The appearance of rust streaks on stainless steel leads to the belief that the stainless steel is rusting. Look for the actual source of the rust in some iron or steel particles which may be touching, but not actually a part of the stainless steel structure.

**NOTICE!** Strongly acidic or caustic cleaners may attack the steel causing a reddish film to appear. The use of these cleaners should be avoided.

## Brand Names

Use of brand names is intended only to indicate a type of cleaner. This does not constitute an endorsement, nor does the omission of any brand name cleaner imply inadequacy. Many products named are regional in distribution, and can be found in local supermarkets, department and hardware stores, or through your cleaning service. It is emphasized that all products should be used in strict accordance with package instructions.