

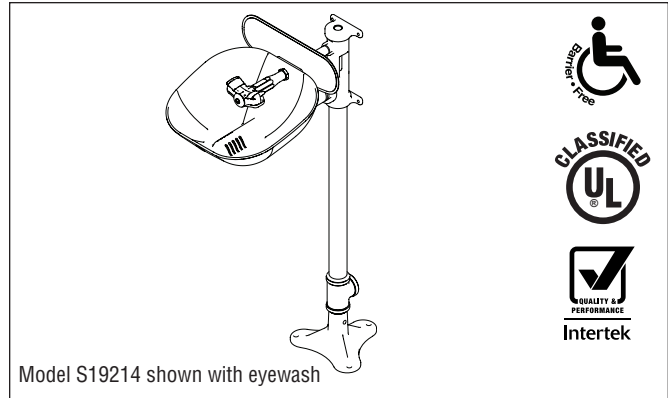

S19214 Series

Pedestal-Mount Halo™ Eyewash or Eye/Face Wash

- Halo™ Delivers the Most Effective Eye/Face Washdown Coverage and Spray Pattern
- Exceeds ANSI/ISEA Z358.1 Specifications
- Exceeds European EN 15154-2
- Industry's Only Self-Draining Design – The Aquaduct™
- Separate Supply and Waste Pipes – Meets CEN and Plumbing Requirements
- Ergonomic Hand Activation Eyewash Paddle – Easy to Reach from Any Direction
- Barrier Free
- Fully-Assembled and Factory-Tested Eyewash or Eye/Face Wash with Hinged Dust Covers
- Yellow Transparent Plastic and Stainless Steel Bowl Covers Available
- Universal Identification Sign and Inspection Tag Included
- Classified by Underwriters Laboratories Inc. to ANSI/ISEA Z358.1.
- Listed by Intertek to EN 15154-2
- Halo™ is Covered by One or More of the Following Patents: 9,700,484; 9,314,398; D662220; D673298; D662605; D685920; D662219; and D671228. Other Patents Pending.



Model S19214 shown with eyewash

Specifications

Standard Eyewash or Eye/Face Wash Units save space and fit easily into any work environment. Halo eyewash or eye/face wash, operated by an ergonomic, highly visible push handle, provides effective wash down coverage and spray pattern. Integral strainer reduces debris in the water and also prevents clogging.

This plumbing fixture is not intended to dispense water for human consumption through drinking or for preparation of food or beverages.

Pipe and Fittings

Piping to 1/2" NPT (BSPP) water supply inlet on unit. Piping to 1-1/4" NPT (BSPP) drain outlet for eyewash. 1/4" piping assembly manufactured of one of the following materials:

- Galvanized steel with BradTect® safety yellow coating
- Type 304 corrosion resistant stainless steel
- Type 316 corrosion-resistant stainless steel

Ball Valve

1/2" stay-open eye and eye/face wash valve manufactured of the following materials and supplied with either type 304 or 316 stainless steel pull rod and handle:

- Chrome-plated brass
- Type 316 stainless steel
- Self-closing chrome-plated brass (self closing eyewash valve may not meet local requirements for eyewash activation).

Eyewash

The Halo eyewash system offers a high performance rinsing platform that provides rapid relief to an individual's eyes that have been injured by chemicals or particulate. The eyewash includes an integral 5.1 GPM (19.2 L) flow control, providing water at a safe velocity while maintaining its effectiveness (exceeds minimum water flow of 0.4 GPM (1.5 L) at 30 PSI (2.0 bar)). Eyewash is protected by flip open dust covers that open when product is activated or by a full bowl dust cover that activates the unit when it is opened. Safe, steady water flow under varying water supply conditions from 30–90 PSI (2.0–6.1 bar) is assured by integral flow control in the sprayhead assembly.

Eye/Face Wash

The Halo eye/face wash system offers a high performance rinsing platform that provides rapid relief to an individual's eyes and face that have been injured by chemicals or particulate. This system provides the most complete face wash available in the market. The eye/face wash includes an integral 5.1 GPM (19.2 L) flow control, providing water at a safe velocity while maintaining its effectiveness (exceeds minimum water flow of 3.0 GPM (11.4 L) at 30 PSI (2.0 bar)). Eye/face wash is protected by flip open dust covers that open when product is activated or by a full bowl dust cover that activates the unit when it is opened. Safe, steady water flow under varying water supply conditions from 30–90 PSI (2.0–6.1 bar) is assured by integral flow control in the sprayhead assembly. Sprayheads are made from an impact resistant ABS plastic, or from durable 304/316 stainless steel with electro-polished finish.

Bowl and Dust Cover

Bowl is constructed of yellow impact-resistant plastic, Type 304 corrosion-resistant stainless steel or Type 316 corrosion-resistant stainless steel. Optional dust cover is constructed of transparent yellow impact-resistant plastic, Type 304 corrosion-resistant stainless steel or Type 316 corrosion-resistant stainless steel.

Activation

Type 304 Stainless steel push handle with optional aluminum or type 304 stainless steel foot pedal. Type 316 stainless steel push handle with optional Type 316 stainless steel foot pedal.

Drench Hose

Perforated sprayhead with protective sprayhead cover is ABS plastic and provides soft spray for cleansing eyes and face. Chrome-plated brass valve with extended handle stays open once handle is squeezed. 8' (2438mm) yellow reinforced thermoplastic hose has 3/8" NPT male thread. Burst strength is 450 PSI (31 bar). Attachment Kit includes 1/2" NPT supply, fittings and hanger for attaching hose to eyewashes. The sprayhead contains an antimicrobial agent to protect the sprayhead.

Backflow Prevention

Series N9 dual-check backflow preventer has a chrome-nickel plated brass body and includes atmospheric vent for continuous pressure applications. The check valve comes with 3/8" female dual NPT female inlet and outlet connections. It can sustain a maximum pressure of 125 PSI (8.6 bars). The check valve is certified to CSA B64.8.

Series 9D dual-check backflow preventer with intermediate atmospheric vent can be used under continuous pressure. The primary check valve uses a rubber disc seating adjacent to a mating rubber part to ensure tight closing. A second check valve employs a rubber disc-to-metal seating.

Tepid Water Options

[Navigator S19-2000 EFX8](#)
[Emergency Throstatic Mixing Valve](#)

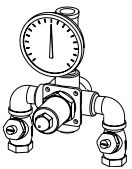

[Keltech CLE-Series](#)
[Tankless Water Heater](#)

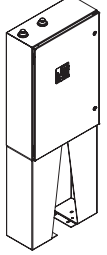

NAVIGATOR

Satisfies ANSI/ISEA Z358.1 tepid water requirements.



Halo Configurator

Standard Selections (Must select one from each category)

Configuration

- B** 24" Drain Height
- 0** 6" Drain Height, Standard

Pipe Material

- A** NPT, Yellow BradTect Galvanized Steel
- B** NPT, All 304 Stainless Steel
- C** NPT, All 316 Stainless Steel *
- D** NPT, Chrome-Plated
- F** BSPP, Yellow BradTect Galvanized Steel‡
- G** BSPP, All 304 Stainless Steel‡
- H** BSPP, All 316 Stainless Steel‡
- J** BSPP, Chrome-Plated‡

Ball Valve

- 1** Stay-Open Eyewash, Chrome-Plated Brass
- 2** Stay-Open Eyewash, 316 SS

Eyewash – Eye/Face Wash

- A** Halo Eyewash
- B** Halo Eye/Face Wash
- D** Halo Eyewash, 304 SS Yoke
- E** Halo Eye/Face Wash, 304 SS Yoke
- F** 304 SS Halo Eye/Face Wash, 304 SS Yoke **
- G** Halo Eyewash, 316 SS Yoke
- H** Halo Eye/Face Wash, 316 SS Yoke
- J** 316 SS Halo Eye/Face Wash, 316 SS Yoke **

* Not available with barrier-free configurations or with chrome plated pipe.
 ** Must select stainless steel pipe and ball valve when stainless steel eye/face wash is required.
 ‡ Not available in the U.S.

NPT = National Pipe Thread

All selections made through the configurator are only UL certified to ANSI/ISEA Z358.1

Bowl and Dust Cover

- A** Plastic Bowl, No Dust Cover
- B** Plastic Bowl, Plastic Dust Cover
- D** 304 SS, No Dust Cover
- E** 304 SS, 304 SS Dust Cover
- F** 304 SS, Plastic Dust Cover
- G** 316 SS, No Dust Cover
- H** 316 SS, 316 SS Dust Cover
- J** 316 SS, Plastic Dust Cover
- 0** No Bowl or Dust Cover

Activation

- A** 300 SS Handle
- B** 316 SS Handle
- C** 300 SS Handle with 300 SS Foot Pedal *
- D** 300 SS Handle with 316 SS Foot Pedal *
- E** 316 SS Handle with 316 SS Foot Pedal *

Drench Hose and Backflow Prevention

- A** Drench Hose Kit with Vacuum Breaker
- B** Drench Hose Kit with N9 Backflow Preventer
- C** Drench Hose Kit with 9D Backflow Preventer
- D** Drench Hose Kit without Backflow Preventer
- 0** No Drench Hose and No Backflow Prevention

Freeze and Scald Protection

- N** Anti-Freeze Valve
- P** Anti-Scald Valve
- R** Anti-Freeze and Anti-Scald Valves
- Z** Anti-Freeze and Anti-Scald Valve Ready
- 0** No Anti-Freeze Valve and No Anti-Scald Valve

How to Specify Model and Configurations for Bradley Halo Products:

Model No. S19214



- 1. Configuration
- 2. Pipe Material
- 3. Ball Valve
- 4. Eyewash – Eye/Face Wash
- 5. Bowl and Dust Cover

- 6. Activation
- 7. Drench Hose and Backflow Prevention
- 8. Freeze and Scald Protection



S19214 Series Pedestal-Mount Halo™ Eyewash or Eye/Face Wash

S19214 shown with Eyewash and Plastic Bowl

Drawing depicts Eyewash. Eye/Face Wash dimensions are the same.

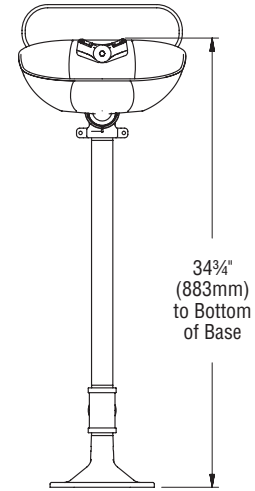
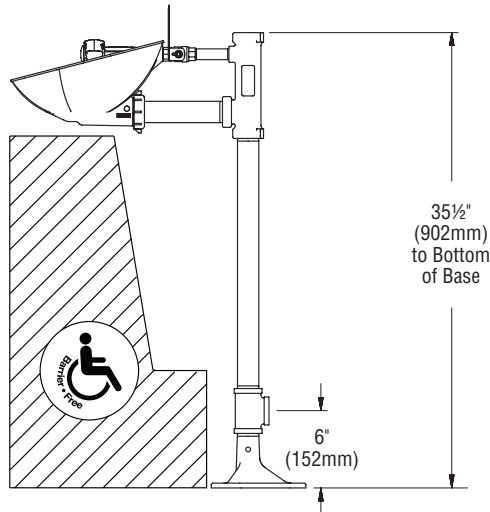

Eyewash Bowl

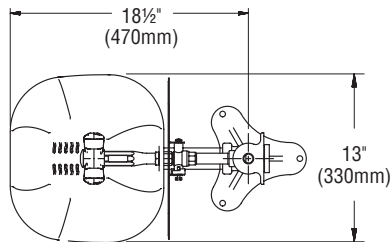

S19-430EH Drench Hose

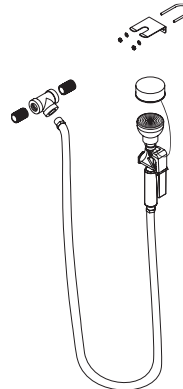

Foot Pedal Activation

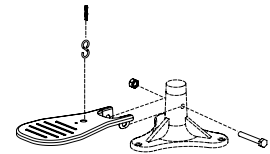

Dust Cover

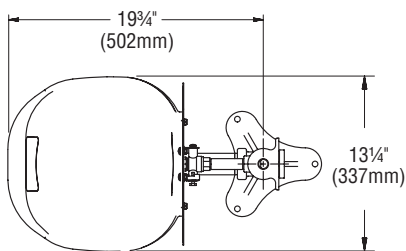

All dimensions assume standard thread engagement. Variations in manufacturing allow for +/- 1/8" (3mm) per threaded joint. To find the tolerance of a dimension, add the number of thread joints across the length of the dimension and multiply it by 1/8" (3mm).