

Mills Plastic Laminate Partitions Service Parts

List Price Book 0213MSP

Effective Date February 1, 2013

Table of Contents

Layouts with Reference Numbers

Series 400 (Floor-Mount with Overhead Brace) and Series 500 (Floor-Braced)	2
Series 600 (Ceiling-Hung) and Series 700 (Floor-to-Ceiling)	3

Headrail Part Numbers and Kits

① Headrail	4
② Headrail Open-End Kit	4
③ Headrail Between-the-Wall Kit	4

Shoes and Sleeves

④ Shoe/Sleeve Kits	5-6
--------------------	-----

Inswing and Outswing Door Kits

⑤ Inswing Door Kit	7
⑥ Outswing Door Kit	7

Pilaster and Panel Kits

⑦ Pilaster at Wall "F" Kit	8
Pilaster at Panel "F" Kit	8
⑧ Dividing Panel Kit	8
⑨ End Panel Kit	8

Additional Kits

Alcove Kits	9
Urinal Screen Bracket Kit	9
Coat Hook Inswing Kit	10
In/Out Latch and Keeper Assembly	10
Coat Hook Outswing Kit	10
Door Pull and Wall Bumper Kit	10
Wall Bumper Kit	10
Flat Strike Kits	11

Series 400 and Series 500 Layouts

Series 400

Floor-Mounted with Overhead Brace

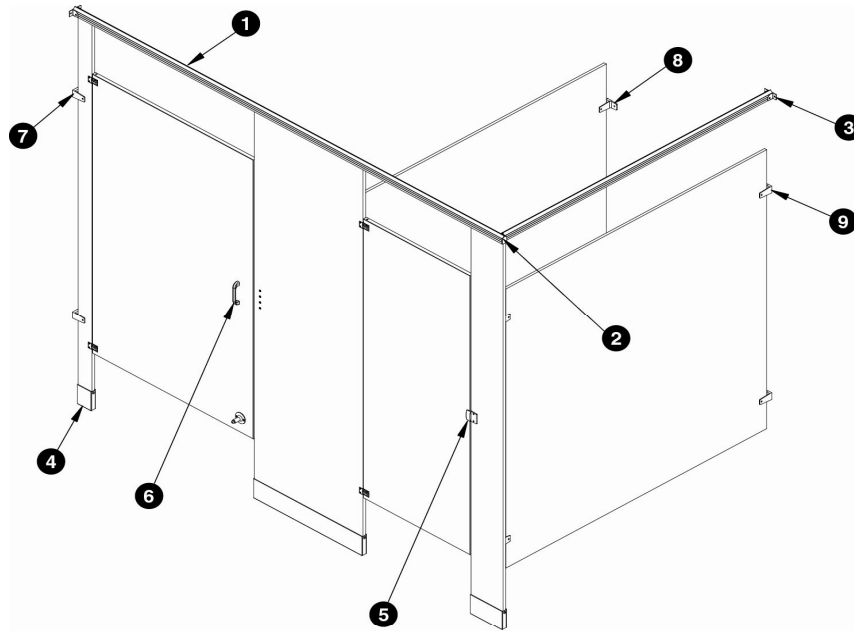

Series 500

Floor-Braced

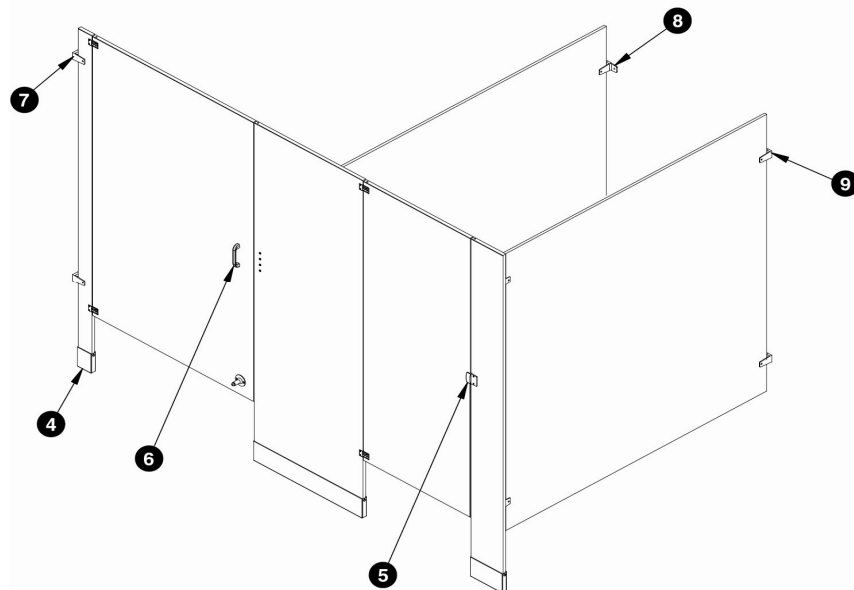

Effective Date February 1, 2013

Series 600 and Series 700 Layouts

Series 600
Ceiling-Hung

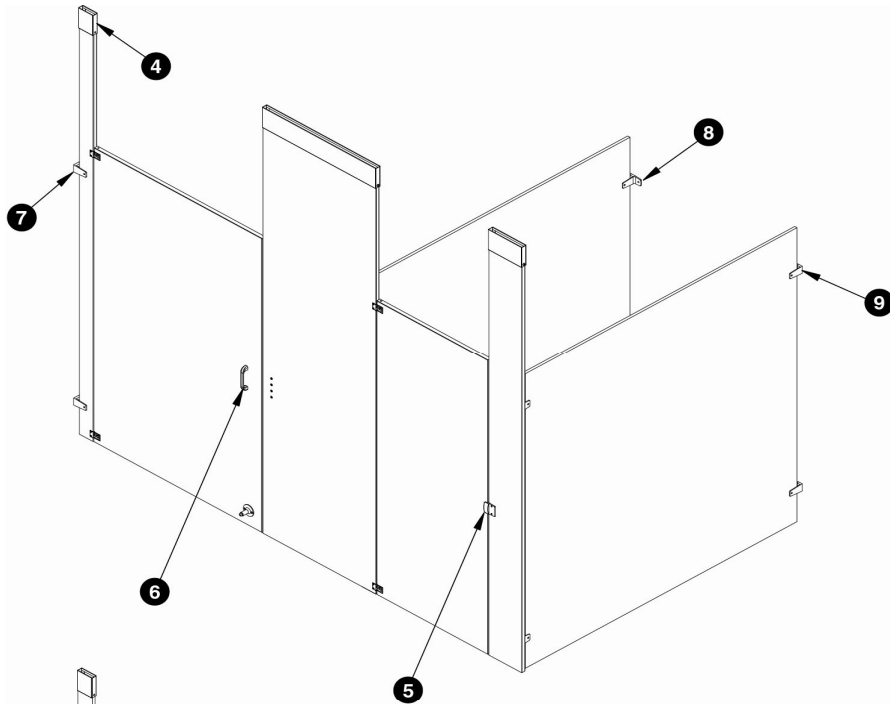

Series 700
Floor-to-Ceiling

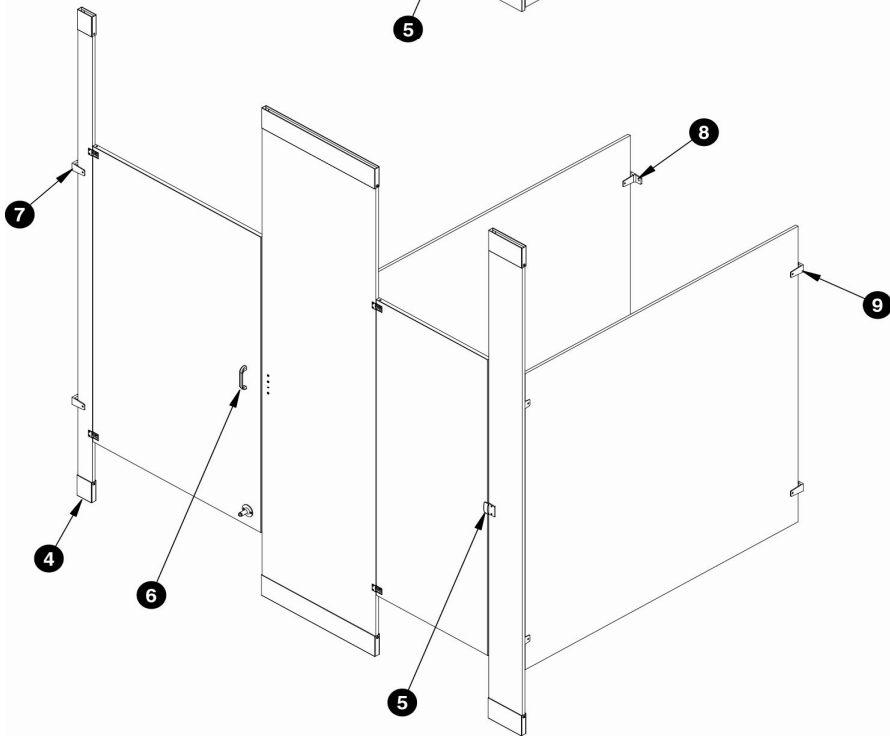

Effective Date February 1, 2013

Headrail and Headrail Kits

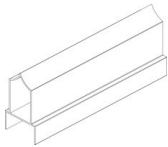
① Headrail only (mounting kits sold separately)	Part No.	Description	Qty.	List Price
	HDWT-A0431-037	Actual Size 37"	1	\$ 18.00
	HDWT-A0431-059	Actual Size 59"	1	\$ 26.00
	HDWT-A0431-062	Actual Size 62"	1	\$ 29.00
	HDWT-A0431-073	Actual Size 73"	1	\$ 36.00
	HDWT-A0431-084	Actual Size 84"	1	\$ 41.00
	HDWT-A0431-120	Actual Size 120"	1	\$ 61.00

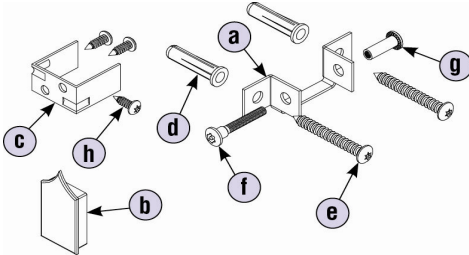
② Headrail Open End Kit	HDWT-A0435-OE	List Price		
	Includes:	\$ 21.00		
	a	HDWT-S0433	Bracket - Headrail 1 1/4"	2
	b	HDW0-P0432	End Cap - Headrail 1 1/4"	1
	c	HDWT-A0161	Bracket - Headrail Internal 1 1/4"	1
	d	FAST-T373	Anchor - Plastic #14-16 x 1 3/8" Lg.	4
	e	FAST-Z002	Screw #14 x 2" Sheet Metal Torx-T27 w/Pin ZP	4
	f	FAST-Z0003	Screw #10-24 x 1 3/8" Step-Male Torx-T27 w/Pin ZP	2
	g	FAST-Z003	Screw #10-24 x 3/4" Barrel-Female Torx-T27 w/Pin ZP	2
h	FAST-Z0019	Screw #10 x 5/8" Sheet Metal Torx-T27 w/Pin ZP	8	

NOTE: Torx bits are not included but can be ordered separately.

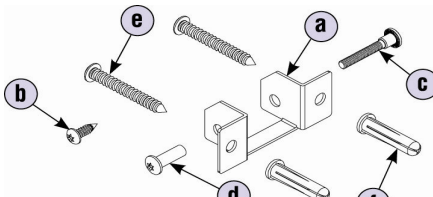
③ Headrail Between-the-Wall Kit	HDWT-A0434-BW	List Price		
	Includes:	\$ 13.00		
	a	HDWT-S0433	Bracket - Headrail 1 1/4"	2
	b	FAST-T373	Anchor - Plastic #14-16 x 1 3/8" Lg.	4
	c	FAST-Z002	Screw #14 x 2" Sheet Metal Torx-T27 w/Pin ZP	4
	d	FAST-Z0003	Screw #10-24 x 1 3/8" Step-Male Torx-T27 w/Pin ZP	2
	e	FAST-Z003	Screw #10-24 x 3/4" Barrel-Female Torx-T27 w/Pin ZP	2
f	FAST-Z0019	Screw #10 x 5/8" Sheet Metal Torx-T27 w/Pin ZP	8	

NOTE: Torx bits are not included but can be ordered separately.

Effective Date February 1, 2013

Shoe Kits

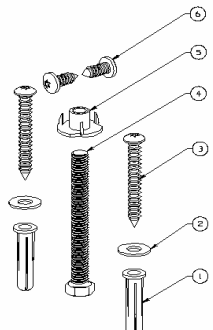
4 Pilaster FMOB Shoe Kit (Stainless Steel)	Part No.	Description	Qty.	List Price
	HDWT-S0451-03	Actual Size 3"	1	\$ 38.00
	HDWT-S0451-04	Actual Size 4"	1	\$ 39.00
	HDWT-S0451-05	Actual Size 5"	1	\$ 40.00
	HDWT-S0451-06	Actual Size 6"	1	\$ 40.00
	HDWT-S0451-07	Actual Size 7"	1	\$ 41.00
	HDWT-S0451-08	Actual Size 8"	1	\$ 41.00
	HDWT-S0451-10	Actual Size 10"	1	\$ 42.00
	HDWT-S0451-12	Actual Size 12"	1	\$ 43.00
	HDWT-S0451-14	Actual Size 14"	1	\$ 44.00
	HDWL-S0451-16	Actual Size 16"	1	\$ 51.00
	HDWT-S0451-18	Actual Size 18"	1	\$ 51.00
	HDWT-S0451-22	Actual Size 22"	1	\$ 57.00
	HDWT-S0451-24	Actual Size 24"	1	\$ 57.00

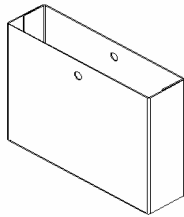

Includes Hardware:			
	Part No.	Description	Qty.
	HDWT-S0443-XX	Pilaster Shoe (XX equals the shoe size)	1
1	FAST-T373	Plastic Anchor #14-16 x 3/8"	2
2	P10-449	Washer .281x .625x .045 Flat 18-8 SS	2
3	FAST-P002	Screw 14 x 2 BTN SM Torx-T27 w/Pin 18-8 SS	2
4	FAST-S0039	Screw 5/16-18 x 3 Hex Cap SS	1
5	FAST-Z0037	Nut-Tee 5/16-18 x 3/8 3 Prong ZP Carbon Steel	1
6	FAST-S355A	Screw 1/4-14 x 5/8" BTN T/S Torx-T27 w/Pin 410SS NKLP	2

NOTE: Torx bits are not included but can be ordered separately.

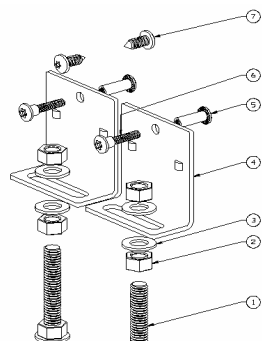
4 Pilaster FB Shoe Kit (Stainless Steel)	Part No.	Description	Qty.	List Price
	HDWT-S0452-03	Actual Size 3"	1	\$ 49.00
	HDWT-S0452-04	Actual Size 4"	1	\$ 50.00
	HDWT-S0452-05	Actual Size 5"	1	\$ 51.00
	HDWT-S0452-06	Actual Size 6"	1	\$ 51.00
	HDWT-S0452-07	Actual Size 7"	1	\$ 52.00
	HDWT-S0452-08	Actual Size 8"	1	\$ 52.00
	HDWT-S0452-10	Actual Size 10"	1	\$ 53.00
	HDWT-S0452-12	Actual Size 12"	1	\$ 54.00
	HDWT-S0452-14	Actual Size 14"	1	\$ 55.00
	HDWL-S0452-16	Actual Size 16"	1	\$ 60.00
	HDWT-S0452-18	Actual Size 18"	1	\$ 60.00
	HDWT-S0452-22	Actual Size 22"	1	\$ 66.00
	HDWT-S0452-24	Actual Size 24"	1	\$ 66.00

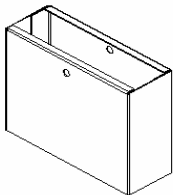

Includes Hardware:			
	Part No.	Description	Qty.
	HDWT-S0446-XX	Pilaster Shoe (XX equals the shoe size)	1
1	FAST-S0040	Wedge Anchor 3/8"-16 x 3-3/4" SS	2
2	FAST-S0041	Nut 3/8"-16 Hex SS	4
3	FAST-S0042	Washer .406x.750x.063 Flat SS	4
4	HDWT-S0439	Leveling Bracket FB/CH	2
5	FAST-Z003	Screw 10-24 x 3/4" BTN Step-Female Torx-T27 w/Pin CHR P	2
6	FAST-Z004A	Screw 10-24 x 1" BTN Step-Male Torx-T27 w/Pin CHR P	2
7	FAST-S355A	Screw 14 x 2 BTN SM Torx-T27 w/Pin 18-8 SS	2

NOTE: Torx bits are not included but can be ordered separately.

Effective Date February 1, 2013

Shoe Kits

4 Pilaster CH Shoe Kit (Stainless Steel)		Part No.	Description	Qty.	List Price
	HDWT-S0453-03	Actual Size 3"	1	\$ 39.00	
	HDWT-S0453-04	Actual Size 4"	1	\$ 39.00	
	HDWT-S0453-05	Actual Size 5"	1	\$ 40.00	
	HDWT-S0453-06	Actual Size 6"	1	\$ 40.00	
	HDWT-S0453-07	Actual Size 7"	1	\$ 41.00	
	HDWT-S0453-08	Actual Size 8"	1	\$ 41.00	
	HDWT-S0453-10	Actual Size 10"	1	\$ 42.00	
	HDWT-S0453-12	Actual Size 12"	1	\$ 44.00	
	HDWT-S0453-14	Actual Size 14"	1	\$ 49.00	
	HDWL-S0453-16	Actual Size 16"	1	\$ 53.00	
	HDWT-S0453-18	Actual Size 18"	1	\$ 53.00	
	HDWT-S0453-22	Actual Size 22"	1	\$ 60.00	
	HDWT-S0453-24	Actual Size 24"	1	\$ 60.00	

Includes Hardware:			
Part No.	Description	Qty.	
HDWT-S0446-XX	Pilaster Shoe (XX equals the shoe size)	1	
1 HDWT-S0439	Leveling Bracket FB/CH	2	
2 FAST-Z003	Screw 10-24 x 3/4" BTN Step-Female Torx-T27 w/Pin CHRFP	2	
3 FAST-Z004A	Screw 10-24 x 1" BTN Step-Male Torx-T27 w/Pin CHRFP	2	
4 FAST-S355A	Screw 1/4-14 x 5/8" BTN T/S Torx-T27 w/Pin 410SS NKLP	2	

4 Ceiling Stud (for Series 600)		Part No.	Description	Qty.	List Price
	HDWT-Z0445-2				\$ 14.00
	a	FAST-L376	Washer 3/8" Flat	6	
	b	FAST-T5416	Rod 3/8"-16 x 6" Threaded	2	
	c	FAST-T680	Washer 3/8" Beveled	2	
	d	FAST-T377	Washer 3/8" Lock	2	
	e	FAST-T375	Nut 3/8"-16 Hex	8	

4 Pilaster FTC Shoe Kit (Stainless Steel)		Part No.	Description	Qty.	List Price
	HDWT-S0454-03	Actual Size 3"	1	\$ 63.00	
	HDWT-S0454-04	Actual Size 4"	1	\$ 64.00	
	HDWT-S0454-05	Actual Size 5"	1	\$ 65.00	
	HDWT-S0454-06	Actual Size 6"	1	\$ 66.00	
	HDWT-S0454-07	Actual Size 7"	1	\$ 67.00	
	HDWT-S0454-08	Actual Size 8"	1	\$ 67.00	
	HDWT-S0454-10	Actual Size 10"	1	\$ 70.00	
	HDWT-S0454-12	Actual Size 12"	1	\$ 74.00	
	HDWT-S0454-14	Actual Size 14"	1	\$ 83.00	
	HDWL-S0454-16	Actual Size 16"	1	\$ 84.00	
	HDWT-S0454-18	Actual Size 18"	1	\$ 87.00	
	HDWT-S0454-22	Actual Size 22"	1	\$ 87.00	
	HDWT-S0454-24	Actual Size 24"	1	\$ 92.00	

Includes Hardware:			
Part No.	Description	Qty.	
HDWT-S0443-XX	Pilaster Shoe (XX equals the shoe size)	1	
HDWT-S0446-XX	Pilaster Sleeve (XX equals the shoe size)	1	
1 FAST-T373	Plastic Anchor #14-16 x 3/8"	2	
2 HDWT-T0440	Bracket "L" FTC	2	
3 FAST-P002	Screw 14 x 2 BTN SM Torx-T27 w/Pin 18-8 SS	2	
4 FAST-S355A	Screw 14 x 2 BTN SM Torx-T27 w/Pin 18-8 SS	4	
1 FAST-T373	Plastic Anchor #14-16 x 3/8"	2	
2 P10-449	Washer.281x .625x .045 Flat 18-8 SS	2	
3 FAST-P002	Screw 14 x 2 BTN SM Torx-T27 w/Pin 18-8 SS	2	
4 FAST-S0039	Screw 5/16-18 x 3 Hex Cap SS	1	
5 FAST-Z0037	Nut-Tee 5/16-18 x 3/8 3 Prong ZP Carbon Steel	1	
6 FAST-S355A	Screw 14 x 2 BTN SM Torx-T27 w/Pin 18-8 SS	2	

NOTE: Torx bits are not included but can be ordered separately.

 Prices subject to change without notice.
 Items may be changed or discontinued
 without notice and without incurring obligation.

Effective Date February 1, 2013

Inswing and Outswing Door Kits

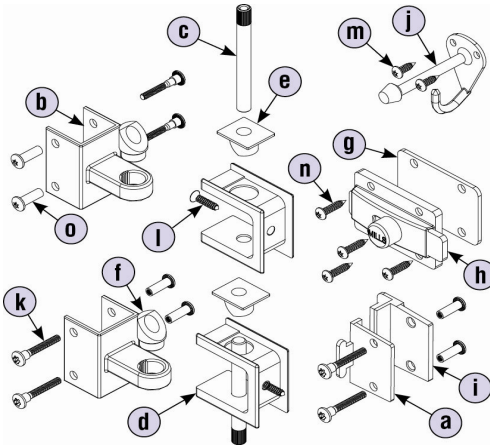
5 Inswing Door Kit	HDWL-ZD1	List Price																																																
	Includes:	\$ 75.00																																																
	<table border="1"> <thead> <tr> <th>Part No.</th> <th>Description</th> <th>Qty.</th> </tr> </thead> <tbody> <tr> <td>a</td> <td>HDWL-C918 Keeper Assembly</td> <td>1</td> </tr> <tr> <td>b</td> <td>HDWL-L102 Hinge Bracket</td> <td>2</td> </tr> <tr> <td>c</td> <td>HDWL-L103 Hinge Pin</td> <td>2</td> </tr> <tr> <td>d</td> <td>HDWL-L104 "U" Insert for Door</td> <td>2</td> </tr> <tr> <td>e</td> <td>HDWL-L117 Nylon Pintle</td> <td>2</td> </tr> <tr> <td>f</td> <td>HDWL-L211 Nylon Cam</td> <td>2</td> </tr> <tr> <td>g</td> <td>HDWL-P0036 Spacer</td> <td>1</td> </tr> <tr> <td>h</td> <td>HDWL-Z160 Latch Assembly</td> <td>1</td> </tr> <tr> <td>i</td> <td>HDWL-Z919 Stop</td> <td>1</td> </tr> <tr> <td>j</td> <td>HDWT-Z285 Coat Hook with Bumper</td> <td>1</td> </tr> <tr> <td>k</td> <td>FAST-Z0003 Screw #10-24 x 1 1/8" Step-Male Torx-T27 w/Pin ZP</td> <td>6</td> </tr> <tr> <td>l</td> <td>FAST-Z0006 Screw #10 x 3/4" Sheet Metal Torx-T25 w/Pin ZP</td> <td>2</td> </tr> <tr> <td>m</td> <td>FAST-Z0019 Screw #10 x 5/8" Sheet Metal Torx-T27 w/Pin ZP</td> <td>2</td> </tr> <tr> <td>n</td> <td>FAST-Z0028 Screw #10 x 1" Sheet Metal Torx-T27 SS</td> <td>4</td> </tr> <tr> <td>o</td> <td>FAST-Z003 Screw #10-24 x 3/4" Barrel-Female Torx-T27 w/Pin ZP</td> <td>6</td> </tr> </tbody> </table>	Part No.	Description	Qty.	a	HDWL-C918 Keeper Assembly	1	b	HDWL-L102 Hinge Bracket	2	c	HDWL-L103 Hinge Pin	2	d	HDWL-L104 "U" Insert for Door	2	e	HDWL-L117 Nylon Pintle	2	f	HDWL-L211 Nylon Cam	2	g	HDWL-P0036 Spacer	1	h	HDWL-Z160 Latch Assembly	1	i	HDWL-Z919 Stop	1	j	HDWT-Z285 Coat Hook with Bumper	1	k	FAST-Z0003 Screw #10-24 x 1 1/8" Step-Male Torx-T27 w/Pin ZP	6	l	FAST-Z0006 Screw #10 x 3/4" Sheet Metal Torx-T25 w/Pin ZP	2	m	FAST-Z0019 Screw #10 x 5/8" Sheet Metal Torx-T27 w/Pin ZP	2	n	FAST-Z0028 Screw #10 x 1" Sheet Metal Torx-T27 SS	4	o	FAST-Z003 Screw #10-24 x 3/4" Barrel-Female Torx-T27 w/Pin ZP	6	
	Part No.	Description	Qty.																																															
	a	HDWL-C918 Keeper Assembly	1																																															
	b	HDWL-L102 Hinge Bracket	2																																															
	c	HDWL-L103 Hinge Pin	2																																															
	d	HDWL-L104 "U" Insert for Door	2																																															
	e	HDWL-L117 Nylon Pintle	2																																															
	f	HDWL-L211 Nylon Cam	2																																															
	g	HDWL-P0036 Spacer	1																																															
	h	HDWL-Z160 Latch Assembly	1																																															
	i	HDWL-Z919 Stop	1																																															
	j	HDWT-Z285 Coat Hook with Bumper	1																																															
	k	FAST-Z0003 Screw #10-24 x 1 1/8" Step-Male Torx-T27 w/Pin ZP	6																																															
	l	FAST-Z0006 Screw #10 x 3/4" Sheet Metal Torx-T25 w/Pin ZP	2																																															
m	FAST-Z0019 Screw #10 x 5/8" Sheet Metal Torx-T27 w/Pin ZP	2																																																
n	FAST-Z0028 Screw #10 x 1" Sheet Metal Torx-T27 SS	4																																																
o	FAST-Z003 Screw #10-24 x 3/4" Barrel-Female Torx-T27 w/Pin ZP	6																																																
Also available in Stainless Steel - HDWL-SD1	\$ 96.00																																																	

NOTE: Torx bits are not included but can be ordered separately.

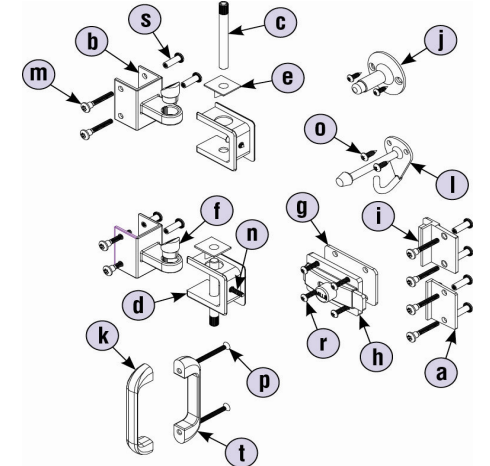
6 Outswing Door Kit	HDWL-ZD2	List Price																																																												
	Includes:	\$ 80.00																																																												
	<table border="1"> <thead> <tr> <th>Part No.</th> <th>Description</th> <th>Qty.</th> </tr> </thead> <tbody> <tr> <td>a</td> <td>HDWL-C918 Keeper Assembly</td> <td>1</td> </tr> <tr> <td>b</td> <td>HDWL-L102 Hinge Bracket</td> <td>2</td> </tr> <tr> <td>c</td> <td>HDWL-L103 Hinge Pin</td> <td>2</td> </tr> <tr> <td>d</td> <td>HDWL-L104 "U" Insert for Door</td> <td>2</td> </tr> <tr> <td>e</td> <td>HDWL-L117 Nylon Pintle</td> <td>2</td> </tr> <tr> <td>f</td> <td>HDWL-L211 Nylon Cam</td> <td>2</td> </tr> <tr> <td>g</td> <td>HDWL-P0036 Spacer</td> <td>1</td> </tr> <tr> <td>h</td> <td>HDWL-Z160 Latch Assembly</td> <td>1</td> </tr> <tr> <td>i</td> <td>HDWL-Z919 Stop</td> <td>1</td> </tr> <tr> <td>j</td> <td>HDWT-Z177 Screw #10-24 x 3/4" Barrel-Female Torx-T27 w/Pin ZP</td> <td>4</td> </tr> <tr> <td>k</td> <td>HDWT-Z282 Door Pull</td> <td>1</td> </tr> <tr> <td>l</td> <td>HDWT-Z285 Coat Hook with Bumper</td> <td>1</td> </tr> <tr> <td>m</td> <td>FAST-Z0003 Screw #10-24 x 1 1/8" Step-Male Torx-T27 w/Pin ZP</td> <td>8</td> </tr> <tr> <td>n</td> <td>FAST-Z0006 Screw #10 x 3/4" Sheet Metal Torx-T25 w/Pin ZP</td> <td>2</td> </tr> <tr> <td>o</td> <td>FAST-Z0019 Screw #10 x 5/8" Sheet Metal Torx-T27 w/Pin ZP</td> <td>4</td> </tr> <tr> <td>p</td> <td>FAST-Z0027 Screw #10-24 x 2" Flat Machine Torx</td> <td>2</td> </tr> <tr> <td>r</td> <td>FAST-Z0028 Screw #10 x 1" Sheet Metal Torx-T27 SS</td> <td>4</td> </tr> <tr> <td>s</td> <td>FAST-Z003 Screw #10-24 x 3/4" Barrel-Female Torx-T27 w/Pin ZP</td> <td>8</td> </tr> <tr> <td>t</td> <td>HDW0-Z0167 Door Pull with Countersink ZP</td> <td>1</td> </tr> </tbody> </table>	Part No.	Description	Qty.	a	HDWL-C918 Keeper Assembly	1	b	HDWL-L102 Hinge Bracket	2	c	HDWL-L103 Hinge Pin	2	d	HDWL-L104 "U" Insert for Door	2	e	HDWL-L117 Nylon Pintle	2	f	HDWL-L211 Nylon Cam	2	g	HDWL-P0036 Spacer	1	h	HDWL-Z160 Latch Assembly	1	i	HDWL-Z919 Stop	1	j	HDWT-Z177 Screw #10-24 x 3/4" Barrel-Female Torx-T27 w/Pin ZP	4	k	HDWT-Z282 Door Pull	1	l	HDWT-Z285 Coat Hook with Bumper	1	m	FAST-Z0003 Screw #10-24 x 1 1/8" Step-Male Torx-T27 w/Pin ZP	8	n	FAST-Z0006 Screw #10 x 3/4" Sheet Metal Torx-T25 w/Pin ZP	2	o	FAST-Z0019 Screw #10 x 5/8" Sheet Metal Torx-T27 w/Pin ZP	4	p	FAST-Z0027 Screw #10-24 x 2" Flat Machine Torx	2	r	FAST-Z0028 Screw #10 x 1" Sheet Metal Torx-T27 SS	4	s	FAST-Z003 Screw #10-24 x 3/4" Barrel-Female Torx-T27 w/Pin ZP	8	t	HDW0-Z0167 Door Pull with Countersink ZP	1	
	Part No.	Description	Qty.																																																											
	a	HDWL-C918 Keeper Assembly	1																																																											
	b	HDWL-L102 Hinge Bracket	2																																																											
	c	HDWL-L103 Hinge Pin	2																																																											
	d	HDWL-L104 "U" Insert for Door	2																																																											
	e	HDWL-L117 Nylon Pintle	2																																																											
	f	HDWL-L211 Nylon Cam	2																																																											
	g	HDWL-P0036 Spacer	1																																																											
	h	HDWL-Z160 Latch Assembly	1																																																											
	i	HDWL-Z919 Stop	1																																																											
	j	HDWT-Z177 Screw #10-24 x 3/4" Barrel-Female Torx-T27 w/Pin ZP	4																																																											
	k	HDWT-Z282 Door Pull	1																																																											
	l	HDWT-Z285 Coat Hook with Bumper	1																																																											
m	FAST-Z0003 Screw #10-24 x 1 1/8" Step-Male Torx-T27 w/Pin ZP	8																																																												
n	FAST-Z0006 Screw #10 x 3/4" Sheet Metal Torx-T25 w/Pin ZP	2																																																												
o	FAST-Z0019 Screw #10 x 5/8" Sheet Metal Torx-T27 w/Pin ZP	4																																																												
p	FAST-Z0027 Screw #10-24 x 2" Flat Machine Torx	2																																																												
r	FAST-Z0028 Screw #10 x 1" Sheet Metal Torx-T27 SS	4																																																												
s	FAST-Z003 Screw #10-24 x 3/4" Barrel-Female Torx-T27 w/Pin ZP	8																																																												
t	HDW0-Z0167 Door Pull with Countersink ZP	1																																																												
Also available in Stainless Steel - HDWL-SD2	\$ 103.00																																																													

NOTE: Torx bits are not included but can be ordered separately.

Effective Date February 1, 2013

Pilaster-Panel Kits

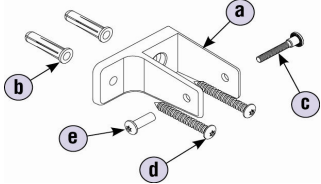
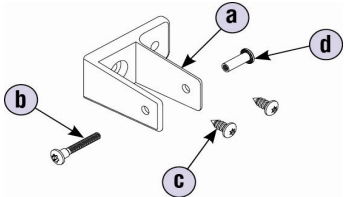
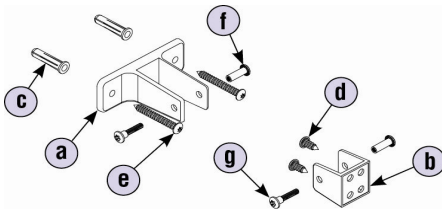
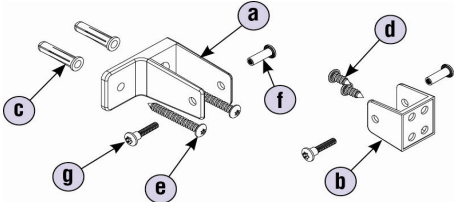
7 Pilaster at Wall "F" Kit	HDWL-Z3FF	List Price																																
	Includes:																																	
	<table border="1"> <thead> <tr> <th></th> <th>Part No.</th> <th>Description</th> <th>Qty.</th> </tr> </thead> <tbody> <tr> <td>a</td> <td>HDWT-T337</td> <td>"F" Bracket</td> <td>2</td> </tr> <tr> <td>b</td> <td>FAST-T373</td> <td>Anchor - Plastic #14-16 x 1 1/8" Lg.</td> <td>4</td> </tr> <tr> <td>c</td> <td>FAST-Z0003</td> <td>Screw #10-24 x 1 1/8" Step-Male Torx-T27 w/Pin ZP</td> <td>2</td> </tr> <tr> <td>d</td> <td>FAST-Z002</td> <td>Screw #14 x 2" Sheet Metal Torx-T27 w/Pin ZP</td> <td>4</td> </tr> <tr> <td>e</td> <td>FAST-Z003</td> <td>Screw #10-24 x 3/4" Barrel-Female Torx-T27 w/Pin ZP</td> <td>2</td> </tr> </tbody> </table>		Part No.	Description	Qty.	a	HDWT-T337	"F" Bracket	2	b	FAST-T373	Anchor - Plastic #14-16 x 1 1/8" Lg.	4	c	FAST-Z0003	Screw #10-24 x 1 1/8" Step-Male Torx-T27 w/Pin ZP	2	d	FAST-Z002	Screw #14 x 2" Sheet Metal Torx-T27 w/Pin ZP	4	e	FAST-Z003	Screw #10-24 x 3/4" Barrel-Female Torx-T27 w/Pin ZP	2	\$ 18.00								
		Part No.	Description	Qty.																														
	a	HDWT-T337	"F" Bracket	2																														
	b	FAST-T373	Anchor - Plastic #14-16 x 1 1/8" Lg.	4																														
c	FAST-Z0003	Screw #10-24 x 1 1/8" Step-Male Torx-T27 w/Pin ZP	2																															
d	FAST-Z002	Screw #14 x 2" Sheet Metal Torx-T27 w/Pin ZP	4																															
e	FAST-Z003	Screw #10-24 x 3/4" Barrel-Female Torx-T27 w/Pin ZP	2																															
Also available in Stainless Steel - HDWL-S3FF		\$ 25.00																																
NOTE: Torx bits are not included but can be ordered separately.																																		
9 Pilaster at Panel "F" Kit	HDWL-Z0016	List Price																																
	Includes:																																	
	<table border="1"> <thead> <tr> <th></th> <th>Part No.</th> <th>Description</th> <th>Qty.</th> </tr> </thead> <tbody> <tr> <td>a</td> <td>HDWT-T337</td> <td>"F" Bracket</td> <td>2</td> </tr> <tr> <td>b</td> <td>FAST-Z0003</td> <td>Screw #10-24 x 1 1/8" Step-Male Torx-T27 w/Pin ZP</td> <td>2</td> </tr> <tr> <td>c</td> <td>FAST-Z0016</td> <td>Screw #14 x 5/8" Sheet Metal Torx-T27 w/Pin ZP</td> <td>4</td> </tr> <tr> <td>d</td> <td>FAST-Z003</td> <td>Screw #10-24 x 3/4" Barrel-Female Torx-T27 w/Pin ZP</td> <td>2</td> </tr> </tbody> </table>		Part No.	Description	Qty.	a	HDWT-T337	"F" Bracket	2	b	FAST-Z0003	Screw #10-24 x 1 1/8" Step-Male Torx-T27 w/Pin ZP	2	c	FAST-Z0016	Screw #14 x 5/8" Sheet Metal Torx-T27 w/Pin ZP	4	d	FAST-Z003	Screw #10-24 x 3/4" Barrel-Female Torx-T27 w/Pin ZP	2	\$ 18.00												
		Part No.	Description	Qty.																														
	a	HDWT-T337	"F" Bracket	2																														
	b	FAST-Z0003	Screw #10-24 x 1 1/8" Step-Male Torx-T27 w/Pin ZP	2																														
c	FAST-Z0016	Screw #14 x 5/8" Sheet Metal Torx-T27 w/Pin ZP	4																															
d	FAST-Z003	Screw #10-24 x 3/4" Barrel-Female Torx-T27 w/Pin ZP	2																															
Also available in Stainless Steel - HDWL-S0016		\$ 56.00																																
NOTE: Torx bits are not included but can be ordered separately.																																		
8 Dividing Panel Kit	HDWL-Z1PD	List Price																																
	Includes:																																	
	<table border="1"> <thead> <tr> <th></th> <th>Part No.</th> <th>Description</th> <th>Qty.</th> </tr> </thead> <tbody> <tr> <td>a</td> <td>HDWT-T334</td> <td>Double-Ear Wall Bracket</td> <td>2</td> </tr> <tr> <td>b</td> <td>HDWT-T336</td> <td>"U" Bracket</td> <td>2</td> </tr> <tr> <td>c</td> <td>FAST-T373</td> <td>Anchor - Plastic #14-16 x 1 1/8" Lg.</td> <td>4</td> </tr> <tr> <td>d</td> <td>FAST-Z0016</td> <td>Screw #14 x 5/8" Sheet Metal Torx-T27 w/Pin ZP</td> <td>4</td> </tr> <tr> <td>e</td> <td>FAST-Z002</td> <td>Screw #14 x 2" Sheet Metal Torx-T27 w/Pin ZP</td> <td>4</td> </tr> <tr> <td>f</td> <td>FAST-Z003</td> <td>Screw #10-24 x 3/4" Barrel-Female Torx-T27 w/Pin ZP</td> <td>4</td> </tr> <tr> <td>g</td> <td>FAST-Z004A</td> <td>#10-24 x 1" Step-Male Torx-T27 w/Pin ZP</td> <td>4</td> </tr> </tbody> </table>		Part No.	Description	Qty.	a	HDWT-T334	Double-Ear Wall Bracket	2	b	HDWT-T336	"U" Bracket	2	c	FAST-T373	Anchor - Plastic #14-16 x 1 1/8" Lg.	4	d	FAST-Z0016	Screw #14 x 5/8" Sheet Metal Torx-T27 w/Pin ZP	4	e	FAST-Z002	Screw #14 x 2" Sheet Metal Torx-T27 w/Pin ZP	4	f	FAST-Z003	Screw #10-24 x 3/4" Barrel-Female Torx-T27 w/Pin ZP	4	g	FAST-Z004A	#10-24 x 1" Step-Male Torx-T27 w/Pin ZP	4	\$ 20.00
		Part No.	Description	Qty.																														
	a	HDWT-T334	Double-Ear Wall Bracket	2																														
	b	HDWT-T336	"U" Bracket	2																														
	c	FAST-T373	Anchor - Plastic #14-16 x 1 1/8" Lg.	4																														
	d	FAST-Z0016	Screw #14 x 5/8" Sheet Metal Torx-T27 w/Pin ZP	4																														
	e	FAST-Z002	Screw #14 x 2" Sheet Metal Torx-T27 w/Pin ZP	4																														
f	FAST-Z003	Screw #10-24 x 3/4" Barrel-Female Torx-T27 w/Pin ZP	4																															
g	FAST-Z004A	#10-24 x 1" Step-Male Torx-T27 w/Pin ZP	4																															
Also available in Stainless Steel - HDWL-S1PD		\$ 41.00																																
NOTE: Torx bits are not included but can be ordered separately.																																		
9 End Panel Kit	HDWL-Z2PE	List Price																																
	Includes:																																	
	<table border="1"> <thead> <tr> <th></th> <th>Part No.</th> <th>Description</th> <th>Qty.</th> </tr> </thead> <tbody> <tr> <td>a</td> <td>HDWT-T332</td> <td>"F" Bracket</td> <td>2</td> </tr> <tr> <td>b</td> <td>HDWT-T336</td> <td>"U" Bracket</td> <td>2</td> </tr> <tr> <td>c</td> <td>FAST-T373</td> <td>Anchor - Plastic #14-16 x 1 1/8" Lg.</td> <td>4</td> </tr> <tr> <td>d</td> <td>FAST-Z0016</td> <td>Screw #14 x 5/8" Sheet Metal Torx-T27 w/Pin ZP</td> <td>4</td> </tr> <tr> <td>e</td> <td>FAST-Z002</td> <td>Screw #14 x 2" Sheet Metal Torx-T27 w/Pin ZP</td> <td>4</td> </tr> <tr> <td>f</td> <td>FAST-Z003</td> <td>Screw #10-24 x 3/4" Barrel-Female Torx-T27 w/Pin ZP</td> <td>4</td> </tr> <tr> <td>g</td> <td>FAST-Z004A</td> <td>#10-24 x 1" Step-Male Torx-T27 w/Pin ZP</td> <td>4</td> </tr> </tbody> </table>		Part No.	Description	Qty.	a	HDWT-T332	"F" Bracket	2	b	HDWT-T336	"U" Bracket	2	c	FAST-T373	Anchor - Plastic #14-16 x 1 1/8" Lg.	4	d	FAST-Z0016	Screw #14 x 5/8" Sheet Metal Torx-T27 w/Pin ZP	4	e	FAST-Z002	Screw #14 x 2" Sheet Metal Torx-T27 w/Pin ZP	4	f	FAST-Z003	Screw #10-24 x 3/4" Barrel-Female Torx-T27 w/Pin ZP	4	g	FAST-Z004A	#10-24 x 1" Step-Male Torx-T27 w/Pin ZP	4	\$ 20.00
		Part No.	Description	Qty.																														
	a	HDWT-T332	"F" Bracket	2																														
	b	HDWT-T336	"U" Bracket	2																														
	c	FAST-T373	Anchor - Plastic #14-16 x 1 1/8" Lg.	4																														
	d	FAST-Z0016	Screw #14 x 5/8" Sheet Metal Torx-T27 w/Pin ZP	4																														
	e	FAST-Z002	Screw #14 x 2" Sheet Metal Torx-T27 w/Pin ZP	4																														
f	FAST-Z003	Screw #10-24 x 3/4" Barrel-Female Torx-T27 w/Pin ZP	4																															
g	FAST-Z004A	#10-24 x 1" Step-Male Torx-T27 w/Pin ZP	4																															
Also available in Stainless Steel - HDWL-S2PE		\$ 38.00																																
NOTE: Torx bits are not included but can be ordered separately.																																		

Effective Date February 1, 2013

Additional Kits

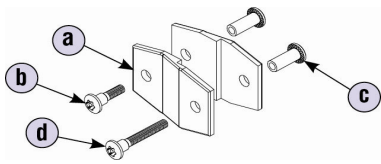
Alcove Kit 	HDWL-Z4AL		List Price
	Includes:		\$ 12.00
	Part No.	Description	Qty.
a	HDWT-T341	Alcove Offset Bracket	2
b	FAST-Z0003	Screw #10-24 x 1 1/8" Step-Male Torx-T27 w/Pin ZP	4
c	FAST-Z003	Screw #10-24 x 3/4" Barrel-Female Torx-T27 w/Pin ZP	4
d	FAST-Z004A	#10-24 x 1" Step-Male Torx-T27 w/Pin ZP	2
Also available in Stainless Steel - HDWL-S4AL			\$ 15.00

NOTE: Torx bits are not included but can be ordered separately.

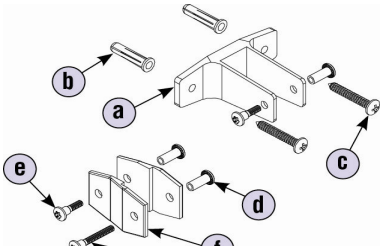
Alcove Dividing Panel Stirrup Kit 	HDWL-Z0286		List Price
	Includes:		\$ 95.00
	Part No.	Description	Qty.
a	HDWT-T334	Double-Ear Wall Bracket	2
b	FAST-T373	Anchor - Plastic #14-16 x 1 3/8" Lg.	4
c	FAST-Z002	Screw #14 x 2" Sheet Metal Torx-T27 w/Pin ZP	4
d	FAST-Z003	Screw #10-24 x 3/4" Barrel-Female Torx-T27 w/Pin ZP	6
e	FAST-Z004A	#10-24 x 1" Step-Male Torx-T27 w/Pin ZP	4
f	HDWT-T341	Alcove Offset Bracket	4
g	FAST-Z0003	Screw #10-24 x 1 1/8" Step-Male Torx-T27 w/Pin ZP	2

NOTE: Torx bits are not included but can be ordered separately.

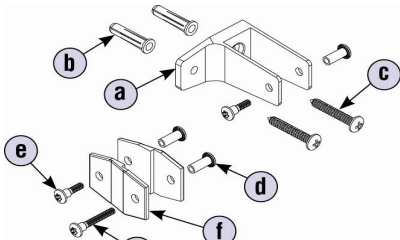
Alcove End Panel Stirrup Kit 	HDWL-Z0287		List Price
	Includes:		\$ 95.00
	Part No.	Description	Qty.
a	HDWT-T332	"F" Bracket	2
b	FAST-T373	Anchor - Plastic #14-16 x 1 3/8" Lg.	4
c	FAST-Z002	Screw #14 x 2" Sheet Metal Torx-T27 w/Pin ZP	4
d	FAST-Z003	Screw #10-24 x 3/4" Barrel-Female Torx-T27 w/Pin ZP	6
e	FAST-Z004A	#10-24 x 1" Step-Male Torx-T27 w/Pin ZP	4
f	HDWT-T341	Alcove Offset Bracket	4
g	FAST-Z0003	Screw #10-24 x 1 1/8" Step-Male Torx-T27 w/Pin ZP	2

NOTE: Torx bits are not included but can be ordered separately.

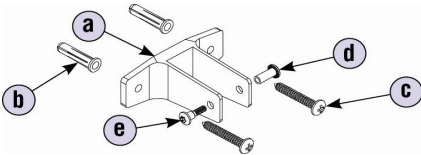
Urinal Screen Bracket Kit 	HDWL-Z5US		List Price
	Includes:		\$ 19.00
	Part No.	Description	Qty.
a	HDWT-T334	Double-Ear Wall Bracket	3
b	FAST-T373	Anchor - Plastic #14-16 x 1 3/8" Lg.	6
c	FAST-Z002	Screw #14 x 2" Sheet Metal Torx-T27 w/Pin ZP	6
d	FAST-Z003	Screw #10-24 x 3/4" Barrel-Female Torx-T27 w/Pin ZP	3
e	FAST-Z004A	#10-24 x 1" Step-Male Torx-T27 w/Pin ZP	3
Also available in Stainless Steel - HDWL-S5US			\$ 27.00

NOTE: Torx bits are not included but can be ordered separately.

Effective Date February 1, 2013

Additional Kits

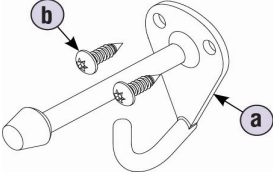
	HDWT-Z0011		List Price	
	Includes:		\$ 17.00	
		Part No.	Description	Qty.
	a	HDWT-Z285	Coat Hook with Bumper	1
	b	FAST-Z0019	Screw #10 x 3/8" Sheet Metal Torx-T27 w/Pin	2
Also available in Stainless Steel - HDWT-S0011			\$ 18.00	
NOTE: Torx bits are not included but can be ordered separately.				

	HDWL-Z0012		List Price	
	Includes:		\$ 36.00	
		Part No.	Description	Qty.
	a	HDWL-C918	Keeper Assembly	1
	b	HDWL-P0036	Spacer	1
	c	HDWL-Z160	Latch Assembly	1
	d	HDWL-Z919	Stop	1
	e	FAST-Z0003	Screw #10-24 x 1 1/8" Step-Male Torx-T27 w/Pin ZP	4
	f	FAST-Z0028	Screw #10 x 1" Sheet Metal Torx-T27 w/Pin ZP	4
	g	FAST-Z003	Screw #10-24 x 3/4" Barrel-Female Torx-T27 w/Pin ZP	4
Also available in Stainless Steel - HDWL-S0012			\$ 46.00	
NOTE: Torx bits are not included but can be ordered separately.				

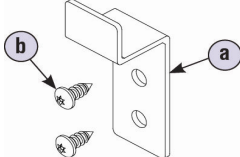
	HDWT-S0013		List Price	
	Includes:		\$ 17.00	
		Part No.	Description	Qty.
	a	HDWT-S275	Coat Hook	1
	b	FAST-Z0016	Screw #14 x 3/8" Sheet Metal Torx-T27 w/Pin ZP	2
NOTE: Torx bits are not included but can be ordered separately.				

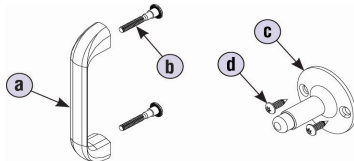
	HDWL-Z0014		List Price	
	Includes:		\$ 27.00	
		Part No.	Description	Qty.
	a	HDWT-Z282	Door Pull	1
	b	FAST-Z0003	Screw #10-24 x 1 1/8" Step-Male Torx-T27 w/Pin ZP	2
	c	HDWT-Z177	Wall Bumper	1
	d	FAST-Z0019	Screw #10 x 3/8" Sheet Metal Torx-T27 w/Pin	2
Also available in Stainless Steel - HDWL-S0014			\$ 34.00	
NOTE: Torx bits are not included but can be ordered separately.				

	HDWT-Z283		List Price	
	Includes:		\$ 13.00	
		Part No.	Description	Qty.
	a	HDWT-Z177	Wall Bumper	1
	b	FAST-Z0019	Screw #10 x 3/8" Sheet Metal Torx-T27 w/Pin	2
Also available in Stainless Steel - HDWT-S283			\$ 23.00	
NOTE: Torx bits are not included but can be ordered separately.				

Effective Date February 1, 2013

Additional Kits

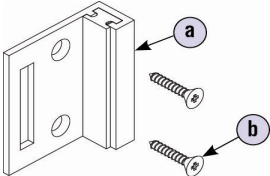
Flat Strike Inswing Kit 	HDWL-Z0030			List Price
	Includes:			\$ 21.00
		Part No.	Description	Qty.
	a	HDWL-Z0029	Strike/Keeper Inswing	1
b	FAST-Z0006	Screw #10 x 3/4" Sheet Metal Torx-T25 w/Pin ZP	2	
Also available in Stainless Steel - HDWL-S0030				\$ 43.00
NOTE: Torx bits are not included but can be ordered separately.				

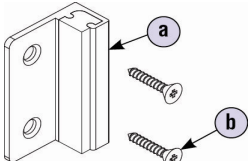
Flat Strike Outswing Kit 	HDWL-Z0031			List Price
	Includes:			\$ 21.00
		Part No.	Description	Qty.
	a	HDWL-Z0128	Strike/Keeper Inswing	1
b	FAST-Z0006	Screw #10 x 3/4" Sheet Metal Torx-T25 w/Pin ZP	2	
Also available in Stainless Steel - HDWL-S0031				\$ 43.00
NOTE: Torx bits are not included but can be ordered separately.				

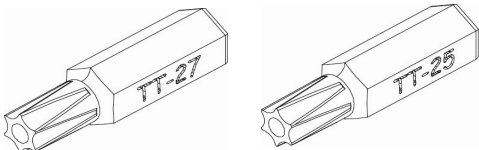
Torx Bits 		Part No.	Description	Qty.	List Price
		HW101031	Torx Bit T27	1	\$ 5.30
		HW101030	Torx Bit T25	1	\$ 5.30