



Key Features

- High quality and modern style complements other [Elvari™ products](#)
- Advanced weld construction
- Concealed BradLock™ magnetic locking system
- Red, low-level indicator
- Non-proprietary liquid soap/gel sanitizer or foam soap

Operation

Manually-activated mechanism dispenses measured amount of vegetable or coconut oil soaps, synthetic detergents, gel sanitizer, or foam soap. Red, low-level indicator provides notice that refill is needed. BradLock system and magnetic key provide security, a seamless design, and easy access for service. Magnetic lock location is hidden from view behind the Bradley logo.

Capacity

40 oz. (1183 mL) liquid soap/gel sanitizer or bulk foam soap

Guide Specification

Surface-mounted soap dispenser shall be fabricated of 20-gauge, 300 series stainless steel in a brushed #3 satin finish or optional electrocoat finishes. Dispenser shall have completely concealed mounting and low-level indicator. Capacity is 40-oz liquid soap/gel sanitizer or bulk foam soap. Mounting hardware is not included.

Overall Dimensions (includes optional drip tray):

18-1/16" H x 6-7/8" W x 3-15/16" D (459mm x 175mm x 100mm)

MasterFormat Title: Commercial Toilet Accessories

MasterFormat Number: 10 28 13.13

OmniClass Title: Toilet and Bath Specialties

OmniClass Code: 23.31.25.00

Product Compliance

Complies with

- The Americans with Disabilities Act (ADA)
- ANSI/ICC A117.1 - Accessible and Usable Buildings & Facilities



Listed by UL Environment to

- GreenGuard Gold



- ☑ Consult local and national accessibility codes for proper installation guidelines. Conformity and compliance with local and national codes is the responsibility of the installer.

Verify all rough-in dimensions prior to installation.



Finishes

- ☑ Click on any color swatch to view as a larger image.



*Electrocoat Finishes, see Optional Electrocoat Finishes section on page 2.

- ☑ Bradley liquid soap valves operate best with vegetable oil or coconut oil hand soap having a 10–15% soap concentration.

- ☑ Bradley foam soap valves work with majority of bulk foam soap.

For information on Warranties, Maintenance and BAA/ARRA Compliance, visit our website at: bradleycorp.com/washroom-accessories-products



Elvari™ Manual Surface-Mounted Soap Dispenser







Optional Electrocoat Finishes

Bradley offers an exclusive, proprietary electrocoat color process on the Elvari soap dispenser models. Unlike powder coating, color is applied to the entire stainless steel part using a submersion process with electrically charged particles. This process results in a precise film thickness across all surfaces, allowing the grain of the stainless steel to show through.

Electrocoat provides complete coverage to the part and has environmental advantages such as no or low-VOC and HAPs (Hazardous Air Pollutants), heavy metal-free products, and minimum waste discharge. Bradley's electrocoat is durable and easy to clean as well as fingerprint, stain and corrosion resistant. A UV light stabilizer additive enhances resistance to weathering and color fade. Products are performance tested for adhesion following ASTM D3359-22 and impact resistance following ASTM D2794.

Soap Dispenser Models

Standard Model Number	Soap Type	Drip Tray
6B1-1100730	Foam	No
6B1-110073T	Foam	Yes
6B1-1100000	Liquid/Gel Sanitizer	No
6B1-110000T	Liquid/Gel Sanitizer	Yes

Model (Must select one)	
6B1	Elvari Soap Dispenser
Standard Selections (Must select one from each category)	
Mounting Type (select one)	
11	Surface Mounted
Activation Type (select one)	
0	Manual
Soap Type (select one)	
0	Liquid Soap/Gel Sanitizer
73	Foam
Drip Tray (select one)	
0	None
T	Standard Drip Tray
Soap Dispenser Finish Type (Must select one)	
BB	 Brushed Black
BR	 Brushed Brass
BZ	 Brushed Bronze
BN	 Brushed Nickel
BS	 Brushed Stainless
SS	 Satin Stainless

Dimensions

(mm)

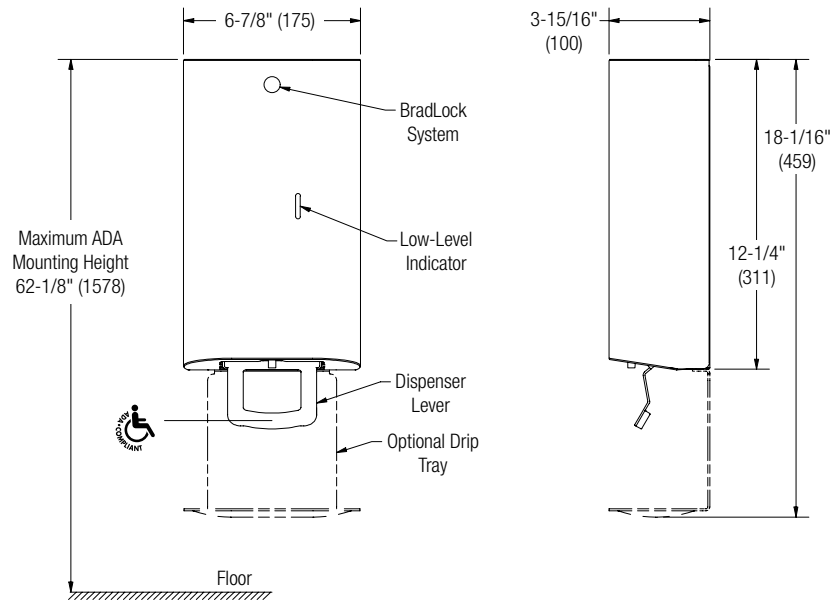

Verify all rough-in dimensions prior to installation.